

Creep Life Prediction for Udimet 720 Material Using the Initial Strain Method (ISM)

Yu-Sik Kong*

*Research Institute for Industrial Technology Development, Dongeui University,
24, Gayadong, Busanjinju, Busan 614-714, Korea*

Han-Ki Yoon

*School of Mechanical Engineering, Dongeui University,
24, Gayadong, Busanjinju, Busan 614-714, Korea*

Sae-Kyoo Oh

*School of Mechanical Engineering, Pukyong National University,
San 100, Yongdangdong, Namgu, Busan 608-739, Korea*

Despite of considerable research results of uniaxial tension creep available for superalloys, few studies have been made on high temperature creep using the Initial Strain Method (ISM). In this paper, the real-time prediction of high temperature creep strength and creep life for the nickel-based superalloy Udimet 720 (high-temperature and high-pressure gas turbine engine materials) was performed on round-bar type specimens under pure static load at the temperatures of 538°C, 649°C, and 704°C. The predictive equation derived from the ISM in creep tests showed better reliability than those from LMP(Larson-Miller Parameter) and LMP-ISM (Larson Miller Parameter-Initial Strain Method) specially for long time creep prediction ($10^3 \sim 10^5$ h)

Key Words: Creep Life Prediction, Initial Strain Method (ISM), Larson-Miller Parameter (LMP), Superalloys, Udimet 720, Rupture Time

1. Introduction

An aircraft's performance depends mainly on its engine performance. In addition, since the engine performance depends on gas turbine materials durable in the circumstances of high temperature, high pressure and corrosion, it is needed to enhance the technology of manufacturing aircraft materials to develop and produce part materials of excellent creep characteristics. During long time use of gas turbine under high temperature conditions, the materials may experience sud-

den rupture due to static (pure) creep or dynamic (cyclic) creep. Hence, it is important in design, manufacture, and exchange of aircraft gas turbine materials to predict and analyze a long time (10^5 h) and high temperature creep characteristics under a certain stress and temperature through the short time ($<10^3$ h) creep tests like the conventional LMP(Larson-Miller Parameter).

There has been little research (Chung et al, 1997; Lee et al, 1997; Oh et al, 1988; 1992; 1993; 1996; Oh, 1998) on the exact correlation between static and dynamic creep and creep life prediction by the ISM(Initial Strain Method) for aircraft gas turbine materials under high temperature. In this paper, the characteristics of static creep for Udimet 720 (U720) aircraft gas turbine material are examined, and the predictive equation of creep life by ISM is derived. Then ISM is compared with LMP and LMP-ISM (Chung et

* Corresponding Author.

E-mail: kyrys@hanmail.net

TEL: +82-51-890-2109; **FAX:** +82-51-890-2109

Research Institute for Industrial Technology Development, Dongeui University, 24, Gayadong, Busanjinju, Busan 614-714, Korea. (Manuscript **Received** May 8, 2001; **Revised** September 10, 2002)

Table 1 Chemical composition of material (wt.%)

Material	C	Cr	Co	Mo	W	Ti	Al	B	Zr	Ni
U720	0.025	18	14.75	3	1.25	5	2.5	0.035	0.035	bal

al, 1997; Lee et al, 1997; Oh et al, 1996; Oh, 1998). To prove the effectiveness of ISM, the real-time prediction of high temperature creep strength and creep life for the nickel-based superalloy Udimet 720 under pure load at the temperatures of 538°C, 649°C and 704°C was performed. In the results it is expected that the predictive equation derived from ISM creep tests would have better reliability than LMP and LMP-ISM equations, and its reliability would be improved specially for long time creep prediction ($10^3 \sim 10^5$ h).

2. Experimental Method

2.1 Materials and specimens

The materials used in this test were superalloys made by Rolls-Royce in England. Tables 1 and 2 show the chemical composition and mechanical properties of U720, respectively. Table 3 shows the conditions of heat treatments of U720. The standard heat treatment by Rolls-Royce is used in this paper. Figure 1 shows the shape of specimens used in this experiment. A creep test machine made by SATEC (DLF-10-1029) was used.

2.2 Experimental method

A K-type thermocouple is used to measure temperature and is attached to the specimen. In the heating process, specimens free of load are heated to a setting temperature with a rate of 8.5°C/min. The furnace is kept at a uniform temperature. Just after the specimen kept at the setting temperature for 30 minutes, it is loaded.

Within the range of $\pm 1^\circ\text{C}$ from the test temperature, the experiment is conducted.

The specimen of Fig. 1 is fixed for the gauge length of 27 mm. By LVDT (linear variable displacement transformer), the strain is measured. The creep curve is plotted by using data from the recorder attached to the control part. The initial strain is measured for one minute since loading.

Table 2 Mechanical properties of U720

(a) Room temperature

Material	Tensile strength σ_t (MPa)	Yield strength σ_y (MPa)	Elongation ϵ (%)	Reduction of area ψ (%)	Vickers hardness Hv
U720	1385	1025	10	11.9	466

(b) High temperatures

Temp.	538°C				649°C				704°C			
	σ_t (MPa)	σ_y (MPa)	ϵ (%)	ψ (%)	σ_t (MPa)	σ_y (MPa)	ϵ (%)	ψ (%)	σ_t (MPa)	σ_y (MPa)	ϵ (%)	ψ (%)
U720	1432	1070	11.9	14.3	1359	941	13	14.3	1233	977	15.1	18.5

Table 3 Heat treatments of U720

Treatment	Temp. \times Time	Cooling	Hv
Standard	1105°C \times 4h	Air cooling	429
	650°C \times 24h	Air cooling	456
	760°C \times 16h	Air cooling	466

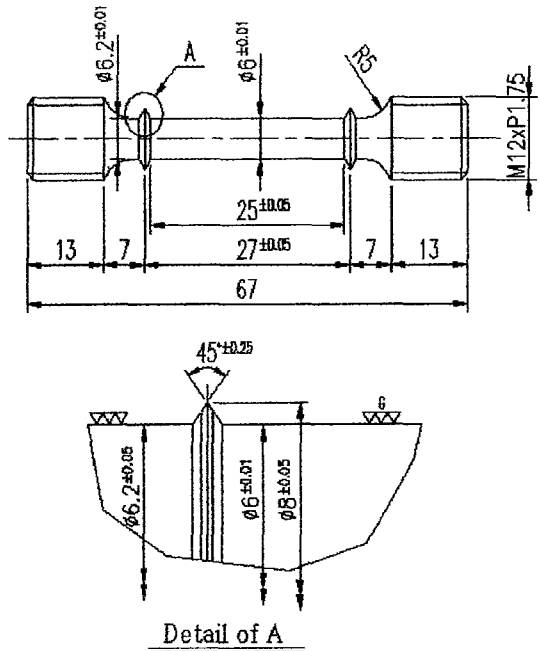

Fig. 1 Shape and dimension of creep specimen (ASTM E139-96) (unit : mm)

3. Experimental Results and Discussions

3.1 High temperature creep test

Figure 2(a), (b) and (c) are creep curves for

U720, where strains are varied under temperatures of 538°C, 649°C and 704°C, respectively. In Fig. 2 (a), (b) and (c), by increasing stress under the same temperatures, it is shown that initial strain is

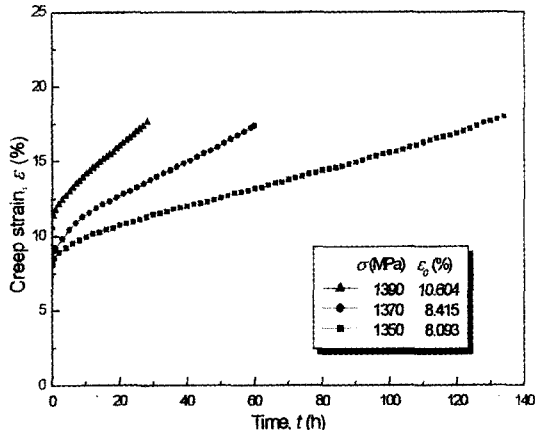

(a) 538°C

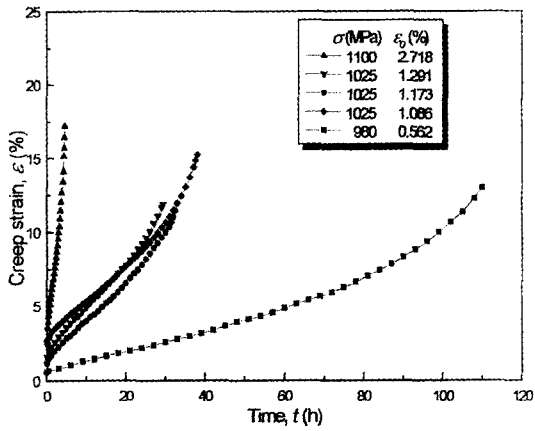

(b) 649°C

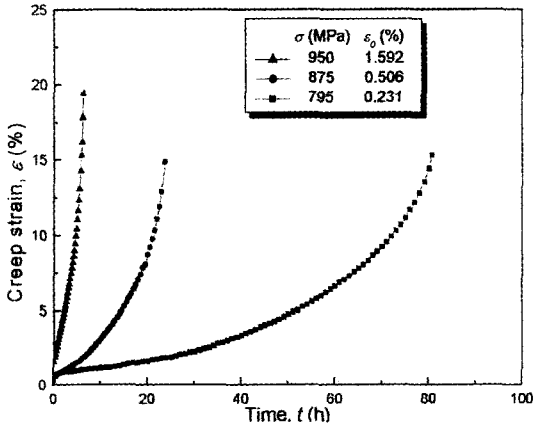

(c) 704°C

Fig. 2 Creep curves for U720 at 538, 649 and 704°C

increased, but rupture time is decreased. It is also shown that the variation of initial strain has a correlation with stress, rupture time and temperature. In this paper, the measured creep initial strain and rupture times under the determined stress and temperature should be quantitatively examined to derive the creep life prediction equation at any temperature, stress and initial strain.

In Fig. 2(a), without the third creep, the specimen is fragmented after the second creep. This is due to the variation of the slip system (depending on temperature) of γ' phase grains which are intermetallic compounds with the $L1_2$ type of regular lattices (Cho and Suh, 1997; Na et al, 1998). In the creep rupture area, intercrystalline fracture appeared at 649°C and 704°C, but transcrystalline fracture appeared at 538°C. It is known that this could be influenced by the size of crystal particles and by an amount of γ' . For the future, it is necessary to examine such properties by the experiment.

Table 4 shows the data obtained from the high temperature creep test of U720 according to standard heat treatment conditions shown in Table 3. The data such as stress (σ , MPa), rupture time

Table 4 Data by creep test of U720 according to standard heat treatment conditions shown in Table 3

Temp.	Stress	Rupture time	Initial strain	Total creep rate	Steady state creep rate	Total strain
°C	σ (MPa)	t_r (h)	ϵ_0 (%)	$\dot{\epsilon}_T$ (%/h)	$\dot{\epsilon}$ (%/h)	ϵ_T (%)
538	1390	28.3	10.604	0.623	0.183	17.640
	1370	60.0	8.415	0.289	0.116	17.369
	1350	134.1	8.093	0.134	0.062	17.979
649	1100	4.6	2.718	3.739	2.184	17.201
	1025	29.3	1.291	0.404	0.284	11.851
	1025	33.0	1.173	0.361	0.260	11.919
	1025	38.0	1.086	0.401	0.240	15.237
	980	109.8	0.562	0.118	0.068	12.969
704	950	6.3	1.592	3.080	1.467	19.402
	875	23.7	0.506	0.626	0.320	14.831
	795	80.7	0.231	0.190	0.047	15.305

(t_r , h), initial strain (ϵ_0 , %), total creep rate ($\dot{\epsilon}_T$, %/h), and steady state creep rate $\dot{\epsilon}$, %/h) are quantitatively obtained from Fig. 2(a), (b) and (c).

3.2 The correlation between initial strain and creep stress

Figure 3 shows the relationship between creep stress σ (MPa) and initial strain ϵ_0 (%). By increasing stress, initial strain is increased linearly as shown in Fig. 3. The experimental equation of quantitative correlation may be represented as the following :

$$\log \sigma = 0.131 \log \epsilon_0 + 3.012 \text{ for } 538^\circ\text{C} \quad (1)$$

$$\log \sigma = 0.092 \log \epsilon_0 + 3.004 \text{ for } 649^\circ\text{C} \quad (2)$$

$$\log \sigma = 0.088 \log \epsilon_0 + 2.961 \text{ for } 704^\circ\text{C} \quad (3)$$

There is a quantitative correlation from Eqs. (1) ~ (3). The general equation can be modeled as the following :

$$\begin{aligned} \log \sigma &= \log A + B \log \epsilon_0 \\ &= \log A \epsilon_0^B \quad (4) \\ \sigma &= A \epsilon_0^B \end{aligned}$$

where A and B are coefficients depending on temperature as the following :

$$\begin{aligned} \log A &= 0.012 + 0.007 T - 4.1 \times 10^{-6} T^2 \\ B &= 1.568 - 0.003 T + 1.541 \times 10^{-6} T^2 \end{aligned}$$

This is coincident with the reports by Oh (Oh et al, 1986 ; Oh, Kim et al, 1996 ; Oh, Jeong et al,

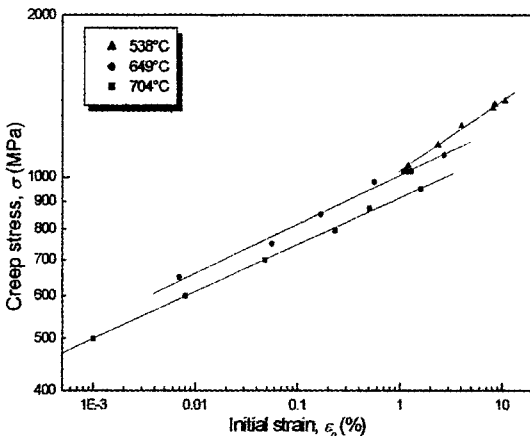

Fig. 3 Relationship between creep stress and initial strain of U720 at 538, 649 and 704°C

1996 ; Oh, 1998). Equation (4) means that the initial strain is the function of stress and temperature. In order to predict the creep life (rupture time), the correlation between initial strain and creep life should be quantitatively examined.

3.3 Correlation between initial strain and creep life

Figure 4 shows the relationship between rupture time t_r (h) and initial strain ϵ_0 (%) of U720 at 538°C, 649°C and 704°C. In Fig. 4, in the logarithm coordinates, the correlation between initial strain and creep life shows quadratic curves through the results of long time creep rupture life tests. By increasing the initial strain, the creep life is decreased. The higher the temperature becomes, the less the decreasing rate becomes. The experimental equations of the quantitative correlation are as follows :

$$\log t_r = 3.859 - 1.101 \log \epsilon_0 - 1.142 (\log \epsilon_0)^2 \text{ for } 538^\circ\text{C} \quad (5)$$

$$\log t_r = 1.608 - 1.799 \log \epsilon_0 - 0.394 (\log \epsilon_0)^2 \text{ for } 649^\circ\text{C} \quad (6)$$

$$\log t_r = 1.081 - 1.167 \log \epsilon_0 - 0.162 (\log \epsilon_0)^2 \text{ for } 704^\circ\text{C} \quad (7)$$

In Eqs. (5) ~ (7), the initial strain has a quantitative correlation with the creep life. Therefore, initial strain has a correlation with various characteristics of high temperature creep such as creep stress, rupture time, steady state creep rate and total creep rate. This is very consistent with Oh's reports (Oh et al, 1986 ; Oh et al, 1996 ; Oh, 1998).

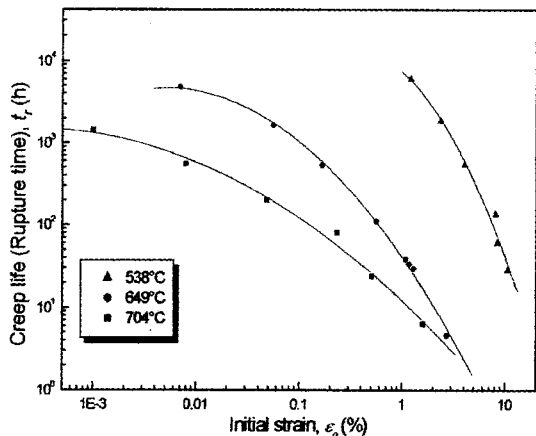

Fig. 4 Relationship between rupture time and initial strain of U720 at 538, 649 and 704°C

Equations (5) ~ (7) can be modeled as follows because $\log t_r - \log \epsilon_0$ has the second order function :

$$\begin{aligned} \log t_r &= \log A' + B' \log \epsilon_0 + C' (\log \epsilon_0)^2 \\ &= \log A' + (B' + C' \log \epsilon_0) \log \epsilon_0 \quad (8) \\ &= \log (A' \epsilon_0^{B'+C' \log \epsilon_0}) \end{aligned}$$

where

$$t_r = A' \epsilon_0^{B'+C' \log \epsilon_0} \quad (9)$$

where A' , B' and C' are the coefficients depending on material and temperature.

3.4 Correlation between creep stress and creep life

Figure 5 shows the relationship between high temperature creep stress σ (MPa) and creep life t_r (h) of U720 at 538°C, 649°C, and 704°C .

In Fig. 5, in the logarithm coordinates, the correlation shows also quadratic curves through the results of long time creep rupture life tests. The experimental equations of the quantitative correlation are as the following :

$$\log \sigma = 3.129 - 0.034 \log t_r - 0.017 (\log t_r)^2 \text{ for } 538^\circ\text{C} \quad (10)$$

$$\log \sigma = 3.035 - 0.020 \log t_r - 0.022 (\log t_r)^2 \text{ for } 649^\circ\text{C} \quad (11)$$

$$\log \sigma = 2.961 - 0.052 \log t_r - 0.045 (\log t_r)^2 \text{ for } 704^\circ\text{C} \quad (12)$$

Equations (10) ~ (12) need life prediction equation including test temperature and initial strain by ISM.

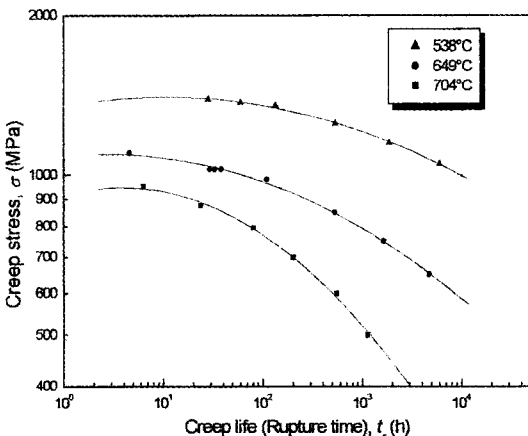

Fig. 5 Relationship between creep stress and creep life of U720 at 538, 649 and 704°C

3.5 Creep life prediction by LMP

The variation of metal structure occurs within a short time at high temperature. Larson-Miller Parameter (LMP) to predict a long time creep life ($>10^3$ h) by an extrapolation of a short time ($<10^3$ h) creep test result is defined as the following (Larson and Miller, 1952):

$$\text{LMP} = T(\log t_r + C_1) \quad (13)$$

In Eq. (13), T is absolute temperature (K) and C_1 is 20, which is a material constant for higher heat-resistant material.

In Fig. 6, the relation between LMP and stress ($\log \sigma$) is linear. Then the equation is as the following :

$$\text{LMP} = T(\log t_r + 20) = K_1 \log \sigma + K_2 \quad (14)$$

where K_1 and K_2 are material coefficients.

Because $K_1 = -16460.4$ and $K_2 = 69312.8$ in $\log \sigma$ and $\text{LMP}[T(\log t_r + 20)]$ graph (Fig. 6) at temperature 538°C, 649°C and 704°C, Eq. (14) becomes the following :

$$\begin{aligned} \text{LMP} &= T(\log t_r + 20) \\ &= -16460.4 \log \sigma + 69312.8 \quad (15) \end{aligned}$$

3.6 Creep prediction by LMP-ISM

It is necessary that the creep life equation should include creep temperature, stress, rupture time and initial strain. Then a creep life prediction equation by using ISM and a creep life equation by using LMP (Larson and Miller,

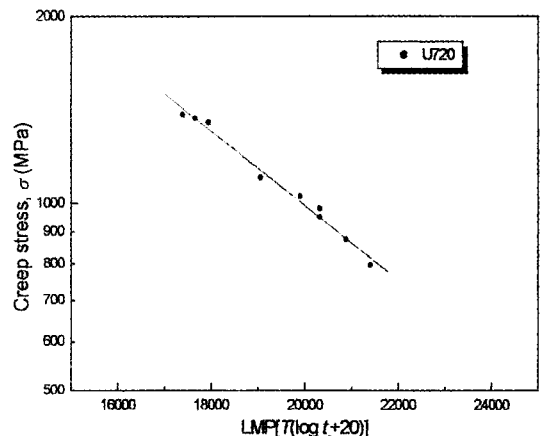

Fig. 6 Master creep curve of U720 at 538, 649 and 704°C

1952) in the previous section 3.5 are combined and we call it the LMP-ISM creep life prediction equation. Because $C_1=20$, the equation of LMP in the previous section is replaced by the following :

$$T(\log t_r + 20) = K_1 \log \sigma + K_2 \quad (16)$$

$$\log t_r = \frac{K_1 \log \sigma + K_2}{T} - 20 \quad (17)$$

where K_1 and K_2 are material coefficients, T is absolute temperature ($K = ^\circ\text{C} + 273$).

Creep life equations by initial strain method were introduced in Eqs. (5)~(7) and then the general equation is expressed as the following :

$$\log t_r = \log A' + B' \log \epsilon_0 + C'(\log \epsilon_0)^2 \quad (18)$$

By combining Eq. (17) and Eq. (18), the LMP-ISM creep life prediction equation becomes the following :

$$2 \log t_r = \frac{K_1 \log \sigma + K_2}{T} + \log A' + B' \log \epsilon_0 + C'(\log \epsilon_0)^2 - 20 \quad (19)$$

where K_1 , K_2 , $\log A$, B and C are as the following :

$$K_1 = -16460.4, K_2 = 69312.8$$

$$\log A' = 74.586 - 0.146 T + 7.233 \times 10^{-5} T^2$$

$$B' = 84.111 - 0.192 T + 1.071 \times 10^{-4} T^2$$

$$C' = -18.448 + 0.034 T - 1.582 \times 10^{-5} T^2$$

$\log A'$, B' and C' are derived by Eq. (8) and Fig. 4.

3.7 Creep life prediction by ISM

The creep life prediction equation by ISM including creep temperature, stress, rupture time and initial strain is as the following :

By combining $\sigma = A\epsilon_0^B$ in Eq. (4) and $t_r = A'\epsilon_0^{B+C} \log \epsilon_0$ in Eq. (9),

$$t_r = AA'\epsilon_0^{B+C} \log \epsilon_0$$

The creep life prediction equation by ISM is obtained as the following :

$$t_r = AA'\epsilon_0^{B+B'+C} \log \epsilon_0 \sigma^{-1} \quad (20)$$

$$\therefore t_r = \alpha \epsilon_0^\beta \sigma^{-1} \quad (21)$$

where α and β are as the following :

$$\alpha = AA' = 10^{74.598 - 0.1397T + 6.823 \times 10^{-5} T^2}$$

$$\beta = \beta' + C' \log \epsilon_0$$

$$\beta' = B + B' = 85.679 - 0.195 T + 1.087 \times 10^{-4} T^2$$

$$C' = -18.448 + 0.034 T - 1.582 \times 10^{-5} T^2$$

In Eq. (21), if stress (σ), temperature (T) and initial strain (ϵ_0) are known, creep life (t_r) can be calculated.

Figure 7 shows the comparison of creep design curves for U720 obtained from LMP Eq. (14), LMP-ISM Eq. (19), and ISM Eq. (21). These three equations are obtained by comparing the experimental data of the materials with standard

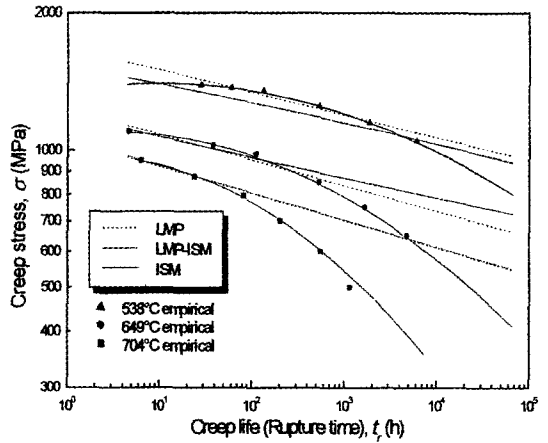

Fig. 7 Comparison of creep design curves for U720 by ISM with those by LMP-ISM, LMP methods and the empirical data at 538, 649 and 704°C

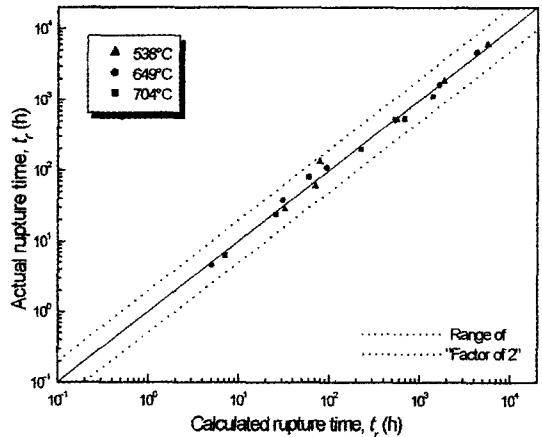

Fig. 8 Comparison of actual rupture time and calculated rupture time for U720 by ISM at 538, 649 and 704°C

heat treatments at 538°C, 649°C, and 704°C.

LMP has a small error in a short time ($<10^3$ h), but has a big error for a long time ($>10^3$ h). It is dangerous to use LMP. Because LMP-ISM has a similar pattern, it is not useful in long time creep life prediction over 10^2 hours. But, because ISM is useful in long time ($>10^3$ h) life prediction and also is very consistent with the experimental data, the reliability of the creep prediction equation by ISM proposed in this paper is very high. Figure 8 also shows this fact.

Figure 8 shows a comparison between both creep life (rupture time) calculated from the life prediction equation by ISM and real rupture time (experimental data).

In Fig. 8, the creep life (rupture time) calculated from the creep life prediction equation derived by ISM tests and the real creep life data obtained from experimental data are generally consistent. Therefore, the creep life prediction equation by ISM has a high reliability as the creep life prediction equation including creep temperature, stress, and initial strain.

4. Conclusions

The results of high temperature creep life prediction by ISM for the superalloy (Udimet 720) used as aircraft gas turbine materials are as the following :

(1) The long time creep characteristics such as steady state creep rate and total creep rate have quantitative relationship with the initial strain. The initial strain can be used to predict the long time creep life.

(2) The following creep life prediction equation by LMP is useful until 10^2 hours, but because creep life is longer than real rupture time in a long time ($10^3\sim 10^5$ h) prediction, it is dangerous to use LMP. The equation is as follows :

$$\text{LMP}[T(\log t_r + C_1)] = K_1 \log \sigma + K_2$$

where $C_1=20$, $K_1=-16460.4$, $K_2=69312.8$

(3) The higher the stress is, the higher the initial strain, the temperature, and the increasing rate become. The relation between stress (σ) and initial strain (ϵ_0) can be modeled as the follow-

ing :

$$\sigma = A \epsilon_0^B$$

where A and B are as the following :

$$A = 10^{0.012 + 0.007T - 4.1 \times 10^{-6}T^2}$$

$$B = 1.568 - 0.003T + 1.541 \times 10^{-6}T^2$$

(4) The creep life prediction equation by ISM is proposed as the following. It has a higher reliability than the prediction equations by LMP and LMP-ISM and also a high reliability in a long time of $10^3\sim 10^5$ h creep life prediction.

$$t_r = \alpha \epsilon_0^\beta \sigma^{-1}$$

where α , β are as the following :

$$\alpha = 10^{74.598 - 0.139T + 6.823 \times 10^{-5}T^2}$$

$$\beta = \beta' + C' \log \epsilon_0$$

$$\beta' = 85.679 - 0.195T + 1.087 \times 10^{-4}T^2$$

$$C' = -18.448 + 0.034T - 1.582 \times 10^{-5}T^2$$

References

- Cho, H. S. and Suh, S. J., 1997, "Friction Welding of Inconel 713C and SCM 440," *Journal of the Korean Welding Society*, Vol. 15, No. 6, pp. 564~570.
- Chang, M. H., Lee, S. G., Hur, K. B., Oh, S. K. and Lee, W. S., 1997, "Assessment on Creep Properties of High-Temperature Pipeline Materials in Power Plants (1)," *Proc. of KSME Spring Annual Meeting A*, pp. 80~85.
- Larson, F. R. and Miller, J., 1952, "A Time Temperature Relationship for Rupture and Creep Stresses," *Transaction of the ASME*, pp. 765~775.
- Lee, S. G., Chang, M. H., Yun, B. S., Oh, S. K. and Song, J. K., 1997, "Assessment on Creep Properties of High-Temperature Pipeline Materials in Power Plants (1)," *Proc. of KSME Spring Annual Meeting A*, pp. 63~67.
- Na, Y. S., Kim, S. E. and Park, N. K., 1998, "Sigma Precipitation Behavior in Udimet 720Li Using X-ray diffraction method," *Journal of the Korean Inst. of Met. & Mater.*, Vol. 36, No. 4, pp. 481~485.
- Oh, S. K., Kunio, T. and Hasui, A., 1986, "Effect of Initial Strain on Evaluation of High

Temperature Creep Properties of Friction Welded Joints," *Proc. of Asian-Pacific Congress on Materials Strength Evaluation-86*, pp. 549~554.

Oh, S. K., Park, J. B., Oh, J. H., Song, Y. S. and Jang, J. H., 1992, "Study on Relationship between High Temperature Creep Properties and Initial Strain of Zircaloy-4," *Proc. of KSME*, Nov., pp. 93~96.

Oh, S. K., Yoon, M. H., Jeong, S. U. and Oh, J. H., 1993, "Optimization of Heat Resisting Steels Friction Welding and Its Initial Real-Time Predictability of High Temperature Creep Life of Long Time (I)," *Transaction of KSME*, Vol. 17, No. 3, pp. 512~519.

Oh, S. K., Jeong, S. U. and Oh, J. H., 1993, "Optimization of Heat Resisting Steels Friction Welding and Its Initial Real-Time Predictability of High Temperature Creep Life of Long Time (II)," *Transaction of KSME*, Vol. 17, No. 3, pp. 520~526.

Oh, S. K., Kim, S. J., Jeong, S. U. and Oh, J. H., 1993, "Optimization of Heat Resisting Steels Friction Welding and Its Initial Real-Time Predictability of High Temperature Creep Life of Long

Time (III)," *Transaction of KSME*, Vol. 17, No. 4, pp. 746~754.

Oh, S. K. and Jeong, S. U., 1993, "Long Time Creep Strength and Life Prediction of Steam Turbine Rotor Steel by Initial Strain Method," *Transaction of KSME*, Vol. 17, No. 6, pp. 1321~1329.

Oh, S. K., Kim, S. J. and Jeon, T. E., 1996, "Development of Long-Time Creep Safety Life Prediction of Steam Turbine Rotor Steel and AE Evaluation (1st Report)-Possibility of Creep Prediction by Initial Strain Method," *Proc. of 6th International Offshore and Polar Eng. Conf., ISOPE, Los Angeles*, pp. 275~279.

Oh, S. K., Jeong, S. U. and Jeon, T. E., 1996, "Improvement of Long-Time Life Prediction of Steam Turbine Rotor Steel," *Journal of Ocean Engineering and Technology, KCORE*, Vol. 10, No. 1, pp. 47-52.

Oh, S. K., 1998, "Relationship between Cyclic Creep Properties and Initial Strain of Cr-Mo Alloy Steels at High Temperatures and AE Evaluation," *International Journal of Ocean Engineering and Technology*, Vol. 1, No. 1, pp. 78~86.