

Multi-Step Commutation and Control Policies for Matrix Converters

Wilfried Hofmann* and Marcus Ziegler

Lehrstuhl Elektrische Maschinen und Antriebe, Chemnitz University of Technology, Chemnitz, Germany

ABSTRACT

The commutation and control in matrix converters is more complicated as in voltage source converters. Natural freewheeling paths do not exist and the theoretic absent storage elements result in a direct coupled system of load and line currents as well as voltages. The paper offers an overview about staggered commutation and control policies in matrix converters. Based on the knowledge about load current direction and the signs of the line to line input voltages different multi-step commutation policies were derived. This paper examines the application of that policies in the case of space vector modulation and direct control methods with the focus on the resulting effects to the reference output voltage deviation.

Keywords: Matrix converter, commutation, control

1. Introduction

The Matrix Converter (MC) shown in Figure 1 seems to be an universal all in silicon converter because of its inherent bidirectional power flow with any desired number of input and output phases. Theoretically there is no need of costly and space consuming storage elements. Therefore the MC is predestinated for future decentralized drive systems^[1].

Nowadays the MC is close to be introduced on the niche market. EUPEC and the ROCKWELL Science Centre co-designed already an integrated MC module for one output line of a 3x3 MC^[2]. Modules with bi-directional switches have been also presented in [3].

The module is based on six IGBTs and six diodes, rated for 100A/1200V and includes also the drivers. SIEMENS published control and protection strategies^[4] and designed

in co-operation with EUPEC in a so called EconoPACK3 sized module a three phase 7.7kW matrix converter^[5]. Finally IXYS presented the first batched fabricated reverse blocking IGBT (50A/ 1200V)^[6]. In addition cheap, fast and high integrated controllers are available to control the MC.

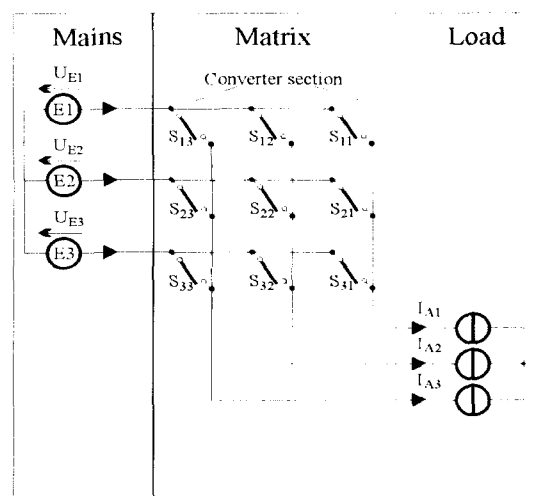

Fig. 1. Ideal 3x3 matrix converter technology.

Manuscript received May 7, 2002; revised Nov. 6, 2002

Corresponding Author: wilfried.hofmann@e-technik.tu-chemnitz.de Tel: +49-371-531-3323, Fax: +49-371-531-3323

But since Gyugyi^[7] presented his Ph.D thesis including the theory of the MC it took almost a quarter century until the industrial research presented a real MC with the remarkable output power of 22kW^[8]. The main reasons for the long time from theory to industrial interest are the commutation problem, especially in the case of small currents or during a change of the sign of the line to line input voltage and the additional effort to implement the more complicated control algorithms.

2. Commutation

2.1 Commutation Problem

To illustrate the commutation problem a sample circuit with real power mains which are affected with leakage inductances L_{N1} and L_{N2} , switches S_{11} , S_{21} , a RL-load and optional capacities C_1 , C_2 as filter is shown in Figure 2. It is supposed that the filter capacities exist and S_{11} is switched on and conducts the load current I_A . The difficulty is to commutate the load current to switch S_{21} . If S_{11} is turned off in a first step, L_L will generate an overvoltage:

$$U_L = L \frac{di}{dt} \tag{1}$$

which could destroy the semiconductors. A free-wheeling path comparable with the diodes at the Voltage Source Inverter does not exist. The stored energy of L_{N1} will flow in the filter capacity C_1 . If S_{21} is turned on in a first step, the capacities will be shorted directly. If there are no filter capacities a short circuit path will be established through $N1-L_{N1}-S_{11}-S_{21}-L_{N2}-N2$. The short circuit current is only limited by small leakage inductances L_{N1} , L_{N2} . In consequence the switching must be theoretically instantaneous and simultaneous to prevent a load current interruption or a short circuit. But in reality there are finite switching times of the semiconductors, delays in the drive circuits and switches.

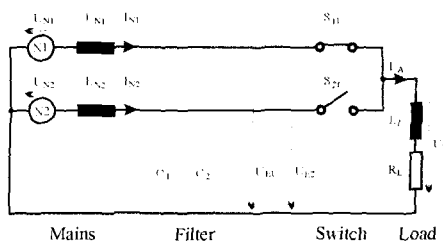

Fig. 2. Commutation problem.

2.2 Real Bidirectional Switch

The MC is based on bidirectional switches also known as 4 quadrant switches. Future design of that switches like presented in [15] will substantially influence the possible commutation policies. But nowadays real bidirectional switches have to be built using discrete power semiconductor elements e.g. as shown in Fig. 3(a), (b). The two different states of a gate G (1: charged, 0: uncharged; Index v: forward, r: reverse) leads in the case of the topology with two transistors/ gates to four different states of a bidirectional switch like shown in Fig. 3(a):

- I : forward blocking, reverse blocking - interruption.
- II : forward conducting, reverse blocking - ideal forward diode
- III : forward blocking, reverse conducting, that is an ideal reverse diode
- IV : forward conducting, reverse conducting - that is bidirectional closed.

The opportunity to control both current directions independently i.e. to have 4 (Fig. 3(a)) instead of 2 (Fig. 3(b)) different states of a bidirectional switch is a crucial part of many proposed commutation schemes and will be focused in this paper. The 4 different switching states of a single bidirectional switch results in the case of 9 bidirectional switches for a 3x3 matrix converter in $4^9 = 262144$ or $2^9 = 512$ different switching states for ideal switches with the two states I and IV. A unit of three bidirectional switches, which are connected to the same output phase is shown in Fig. 1 and named converter section with the three input voltages U_{E1} , U_{E2} and U_{E3} .

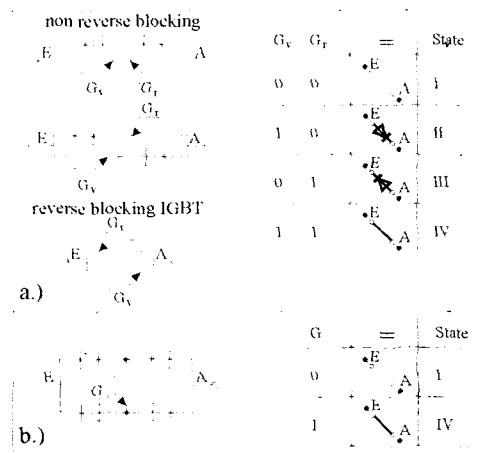

Fig. 3. Discrete structure of bi-directional switches.

2.3 Staggered Commutation Policies

The aim of all commutation strategies is to commute the load current I_A from one input line to another input line, that means to switch from a starting base state to another so called target base state of a converter section with the aid of so called auxiliary states. Most policies are staggered in several steps to prevent short circuits or load current interruption. After every step a dead time of e.g. $5\mu s$ (IGBT, 1200V, 100A) is inserted to avoid short circuits due to the finite switching time of the real switches. In Fig. 7 the resulting control signal is shown which symbolizes to introduce the next switching step. Normally the control signal is given to a gate driver unit with an inherent dead time of around 1ms which is essentially generated by the driver input filter to reduce disturbances. After that dead time the so called switching time follows where the gate will be charged/uncharged what takes around 300 ns (delay time 200ns, fall/rise time 100ns). During the switching-time-interval the state of the converter section will change. The maximum duration from the reference control signal to the end of the switching time will be in this case $1,3\mu s$. For a comparing examination three different stepped commutation policies were exemplary selected where the float diagram is shown in the line1 to 3 of Fig. 7. The selected strategies use appropriate switching patterns, which are based on information about the load current direction and/or the signs of the line to line input voltages.

2.3.1 Four Steps Commutation

Based on the sign of the line to line input voltage of the two involved input phases a staggered 4-step commutation policy was presented in [9] and applied to SITs (Static Induction Thyristors) in [10]. Another idea depend on the load current direction and is shown as an example in Figure 4 for both directions. The policy was first presented in [11] and can be described as follows:

- ⊙ Base state, S_{11} turned on for both current directions
- ① Turn off the unidirectional switch of S_{11} which does not lead the current
- ② Turn on the unidirectional switch of S_{21} which will lead the current in future (natural commutation now if $U_{E2} > U_{E1}$; $I_A > 0$;))
- ③ Turn off the remaining unidirectional switch of S_{11}

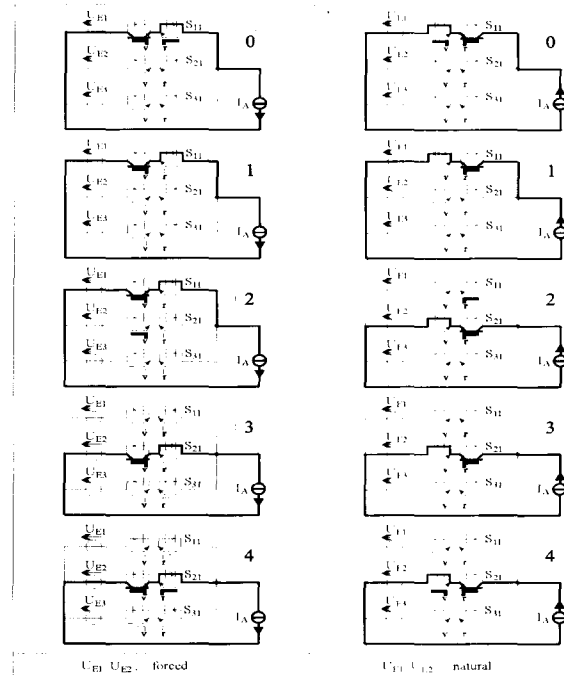

Fig. 4. 4 steps commutation of load current phase 1 to phase 2 without using switches of phase 3; I detection; U don't care.

(forced commutation now if $U_{E2} > U_{E1}$; $I_A < 0$)

- ④ Switch on the remaining IGBT of switch S_{21}

The corresponding flow diagram is shown in line3 of Fig. 7. Dependent on the current direction and the commutation voltage the current will commute either after the second or the third step. Step 1 and Step 4 are only used to switch the unidirectional switches for the inverse current direction of the load current. If one plans an interlock-time of $5\mu s$ per step, a maximum of $20\mu s$ result in the normal case. However, it is possible to reduce the time of the intermediate states.

2.3.2 Two Steps Commutation

If the sign of the load current direction is sure a two steps intelligent commutation results and was presented in [14] and used for a synchronous drive in [12]. Another idea is based on the knowledge about the signs of the line to line input voltages. Then it is possible to switch on a maximum of unidirectional switches without generating a short circuit. It is noted as maximum because any additional switched on IGBT would cause a short circuit or a not wanted commutation. Additional redundant reverse biased IGBTs are switched on, the forward IGBTs

which are connected to a lower input voltage and the reverse IGBTs which are connected to a higher input voltage as the voltage of the set current path. In the static case they do not have any function related to the current flow. Any ever found useful state for a converter section which do not lead to a short circuit will be a subset of switched on IGBTs of that states. One possibility to commute is to switch on the common switched on IGBTs of the starting base state and the target base state (building the cut set). Then a two steps commutation of the load current from a starting input phase to the target input phase is possible as shown in Fig. 5:

- ① Turn off all switches which will not be switched on in the target base state; the auxiliary state will be reached.
- ② Turn on the switches of the target base state: the target state will be reached.

Like shown in line 2 of Fig. 7 the load current can commute after the first or the second step. The whole cycle with two steps takes a minimum of around 10 μ s.

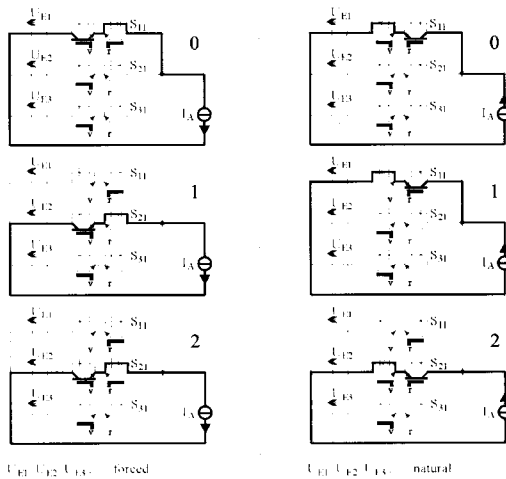

Fig. 5. Two steps commutation.

2.3.3 One Step Commutation

If the signs of the line to line voltages and of the load current are known a commutation in only one step is possible^[16] like shown as an example in Fig. 6:

- ① Turn on the unidirectional switches of target state.

After the commutation step the current will flow in the target current path. The minimum cycle time is 5 μ s.

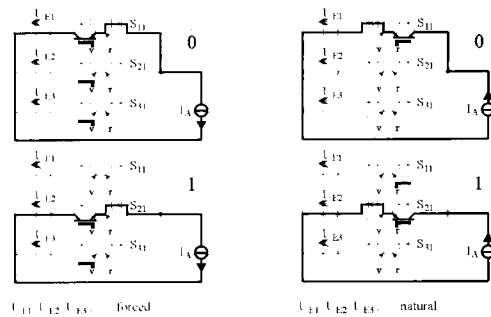

Fig. 6. One step commutation.

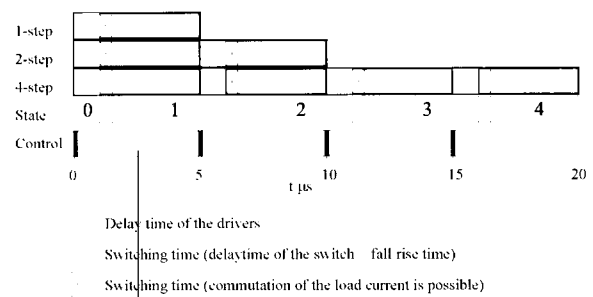

Fig. 7. Float diagram of multi stepped commutation policies.

3. Simulation Results

In Fig. 8 simulation results (switching frequency 10kHz R-L load, $f(U_A)=37,5$ Hz, $U_E=230$ V) of an open loop control of the output voltage U_A of a converter section are shown. The actual voltage U_A is averaged over one pulse cycle period (100 μ s).

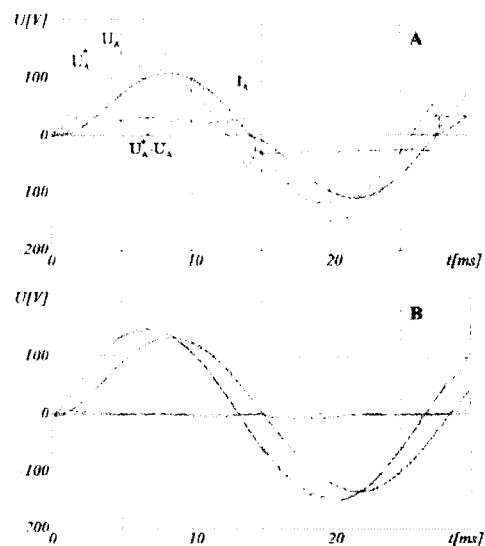

Fig. 8. Simulation results.

Fig. 8(a) shows the results for a 2 steps commutation^[13] with a typical dead time for IGBTs of 5μs (including switching time), and Fig. 8(b) for the dead time less new one steps commutation with a typical minimum switching time of IGBTs of 300ns (delay time 200ns; fall/risetime 100ns). The deviation (-U_d) of the actual output voltage U_A to the set (reference) output voltage and is obvious. In addition the output current amplitude is much higher and more sinusoidal compared to the 2 steps commutation.

4. Control Strategies

4.1 Switching States and Space Vectors

4.1.1 Switching States

The matrix converter for three-phase supplying and load systems consists of a phase matrix possible with 3x3 junctions, see Fig. 1. 3³ switching-combinations that are realizable about bidirectional IGBT-switches result from that. In most cases the input is combined with voltage sources and alternating current capacities and the load side with dominating inductive load concluded. For this case load-sided voltage vectors and main-sided current vectors can be impressed by means of switching combinations listed above.

From these 27 switching-combinations themselves let make following different voltage and current vectors:

- 18 pulsating vectors
- 6 rotating vectors
- 3 zero-vectors

Pulsating vectors arise always if two input phases are combined with three output phases bidirectionally. One of the input phases must be in this case switched to two output phases simultaneously. The length of the voltage vectors to the output changes with the instantaneous value of the input voltage while the position is remaining prospective, see Fig. 9. The corresponding input and output vectors result after formation of a space vector as:

$$\underline{U}_0 = \frac{2}{3} (U_{01} + \underline{a} U_{02} + \underline{a}^2 U_{03}) \tag{5}$$

One receives rotating vectors if every input phase is connected bidirectionally with another output phase. In case of changed over cyclical interchanging the vectors rotate then in left-hand rotation, cf. Fig. 10.

If the assignments are exchanged backwards cyclically, vectors, which turn to the right (Fig. 11) around arise so. These switching and space vector model can be used to the development of effective control methods. In analog mode to the U-converter can be distinguished basically:

- the space vector modulation^[17]
- the direct torque control^[18]

One of these is supposed to be examined with regard to the effects of restrictions, which result from the commutation methods:

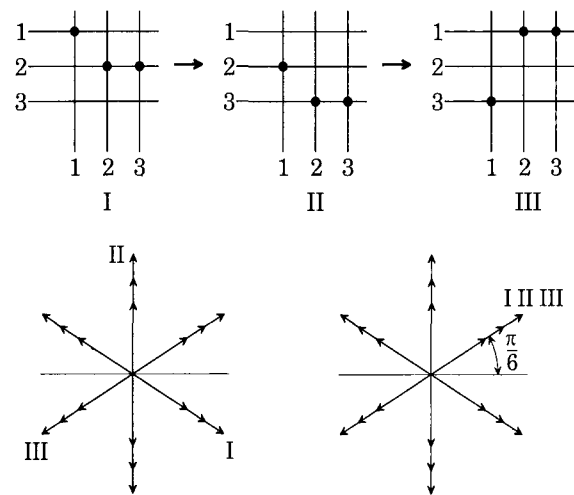

Fig. 9. Switching states and pulsating vectors.

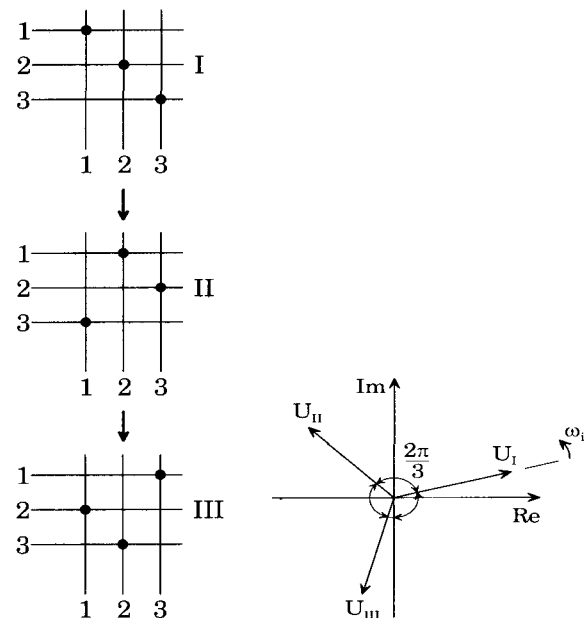

Fig. 10. Switching states and left rotating vectors.

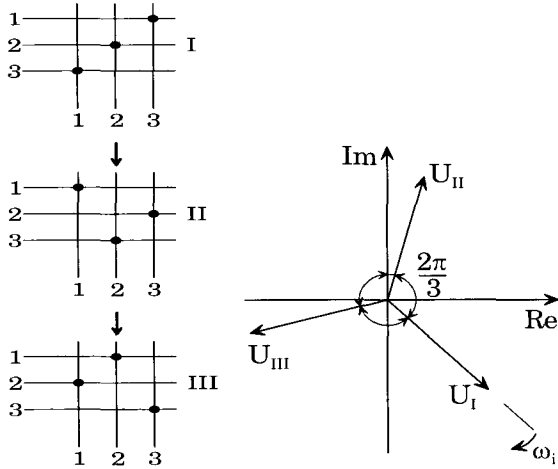

Fig. 11. Switching states and right rotating vectors.

4.1.2 Space Vector Modulation

A control method introduced in the converter technique is the space vector modulation, cf [17]. After that the selection and on-time of different switching-combinations are derived from a rotating reference voltage vector, according to position and amplitude. The reference vector is disassembled for this purpose into individual cursors. At an indirect converter with active front-end converter this procedure can both for the load- than also for the main side are applied as shown in Figs. 12 and 13. For the classical space vector modulation the reference vector can be copied from 3 or also 2 switching-vectors of defined situation and length, at what is valid for:

3-space-vector modulation (1st 60° sector):

$$\begin{aligned} \underline{U}_S &= \frac{T_1}{T_P} \underline{U}_1 + \frac{T_2}{T_P} \underline{U}_2 + \frac{T_0}{T_P} \underline{U}_0 \\ &= \gamma_1 \frac{2}{3} U_d + \gamma_2 \frac{2}{3} U_d e^{j\frac{\pi}{6}} + (1 - \gamma_1 - \gamma_2) \underline{0} \end{aligned} \quad (6)$$

Since the vector sum of the switching-vectors is not identical with the in scalar form added turn-on times the realizable length of the reference voltage vector is limited on:

$$|\underline{U}_{S\max}| = \frac{\sqrt{3}}{3} U_d \quad (7)$$

The same relation can be given in case of the front-end converter. Further the d.c. voltage link can be looked than so far isolating so that no retrospective effects are to be expected.

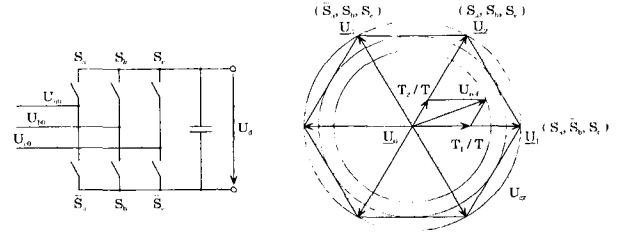

Fig. 12. Space vector modulation for front-end converter.

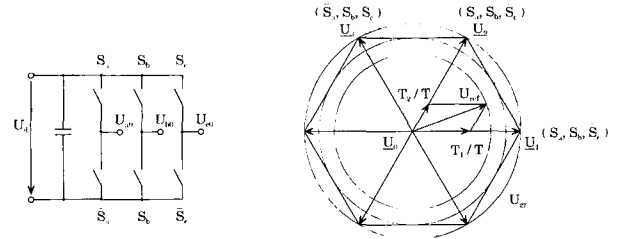

Fig. 13. Space vector modulation for inverter.

At the matrix converter both control functions must be fulfilled input and output-sided in a pulse period.

The reference voltage vector is formed for this purpose in accordance with Fig. 14, first of all.

$$\begin{aligned} \underline{U}_{0ref} &= \underline{U}_l + \underline{U}_r \\ \underline{U}_l &= \frac{T_{1+}}{T_P} \underline{U}_{01+} + \frac{T_{3-}}{T_P} \underline{U}_{03-} \\ \underline{U}_r &= \frac{T_{4-}}{T_P} \underline{U}_{04-} + \frac{T_{6+}}{T_P} \underline{U}_{06+} \end{aligned} \quad (8)$$

where,

$$\begin{aligned} \underline{U}_{01+} &= \frac{2}{\sqrt{3}} \hat{U}_i \cos \alpha_i e^{j\frac{\pi}{6}} \\ \underline{U}_{03-} &= -\frac{2}{\sqrt{3}} \hat{U}_i \cos \left(\alpha_i - \frac{4}{3} \pi \right) e^{j\frac{\pi}{6}} \\ \underline{U}_{04-} &= -\frac{2}{\sqrt{3}} \hat{U}_i \cos \alpha_i e^{j\frac{5}{6}\pi} \\ \underline{U}_{06+} &= \frac{2}{\sqrt{3}} \hat{U}_i \cos \left(\alpha_i - \frac{4}{3} \pi \right) e^{j\frac{5}{6}\pi} \end{aligned} \quad (9)$$

and

$$\begin{aligned} \underline{L}_{iref} &= \underline{L}_l + \underline{L}_r \\ \underline{L}_l &= \frac{T_{3-}}{T_P} \underline{L}_{i3-} + \frac{T_{6+}}{T_P} \underline{L}_{i6+} \\ \underline{L}_r &= \frac{T_{1+}}{T_P} \underline{L}_{i1+} + \frac{T_{4-}}{T_P} \underline{L}_{i4-} \end{aligned} \quad (10)$$

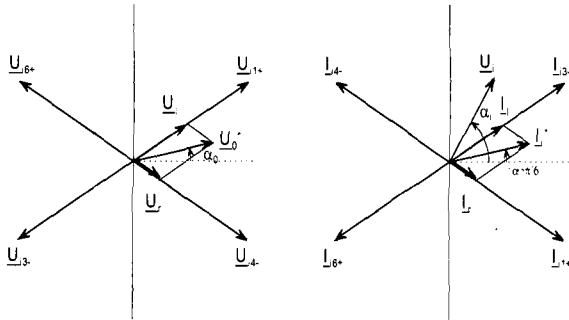

Fig. 14. Space vector modulation for matrix converters.

where,

$$\begin{aligned}
 I_{i1+} &= \frac{2}{\sqrt{3}} \hat{I}_i \cos \alpha_i e^{-j\frac{\pi}{6}} \\
 I_{i3-} &= -\frac{2}{\sqrt{3}} \hat{I}_i \cos\left(\alpha_i - \frac{4}{3}\pi\right) e^{j\frac{7}{6}\pi} \\
 I_{i4-} &= -\frac{2}{\sqrt{3}} \hat{I}_i \cos \alpha_i e^{-j\frac{\pi}{6}} \\
 I_{i6+} &= \frac{2}{\sqrt{3}} \hat{I}_i \cos\left(\alpha_i - \frac{4}{3}\pi\right) e^{j\frac{7}{6}\pi}
 \end{aligned} \quad (11)$$

These equations are more in a complex way nature and, if it is divided into real and imaginary parts, another two more equations must be called in to the solution of the 4 turn-on times:

$$\begin{aligned}
 T_{1+} &= \frac{2}{\sqrt{3}} \frac{U_0}{U_i} T_P \sin(\alpha_0 + \pi/6) \cos(\alpha_i + \pi/6) \\
 T_{3-} &= \frac{2}{\sqrt{3}} \frac{U_0}{U_i} T_P \sin(\alpha_0 + \pi/6) \cos(\alpha_i + \pi/2) \\
 T_{4-} &= \frac{2}{\sqrt{3}} \frac{U_0}{U_i} T_P \sin(-\alpha_0 + \pi/6) \cos(\alpha_i + \pi/6) \\
 T_{6+} &= \frac{2}{\sqrt{3}} \frac{U_0}{U_i} T_P \sin(-\alpha_0 + \pi/6) \cos(\alpha_i - \pi/2)
 \end{aligned} \quad (12)$$

One receives it if one considers the switching effect on the input. The input voltage vector rotating with line frequency supplies in this case the orientation. Considering the minimum cycle-time caused by the commutation method it is possible to divide between two switching reactions if the calculated on-time is lower than the minimum:

- 1) to nought put the turn-on times or to pass the appropriate switching-combination
- 2) limiting the turn-on time on the minimum

4.2 Control Characteristics

The performance of the space vector control is determined by the switching capability of the IGBTs. Mainly the minimal on-time leads to deviations between the reference vectors and the output vectors. The revision of the turn-on times of individual switching conditions and the calculation of the in fact made initial output voltages and positions of the input current show the deviations to Figs. 15-17 at the output-input voltage ratio of 50%.

One can see that the voltage amplitude is more different to the reference voltage amplitude near the sector boundaries (Fig. 15). The position angle is delayed in the first range and after passing the middle of the sector it is expressing (Fig. 16). The result is a more and more distorted phase output voltage as seen in Fig. 17. If a Fourier analysis is used the first harmonic of this real output voltage is decreased. The phase angle is constant.

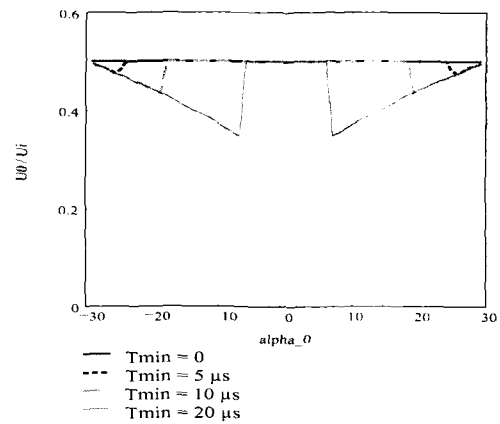
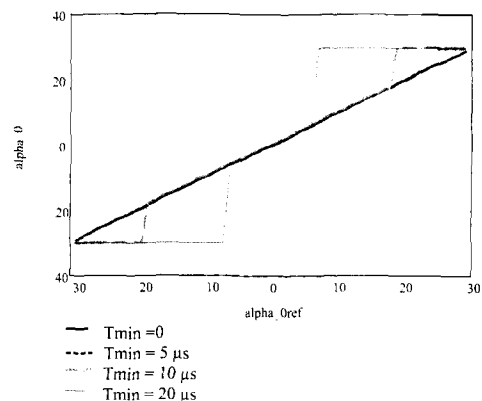
Fig. 15. Amplitude error of output voltage ($T_P=100\mu s$).Fig. 16. Phase angle error of output voltage ($T_P=100\mu s$).

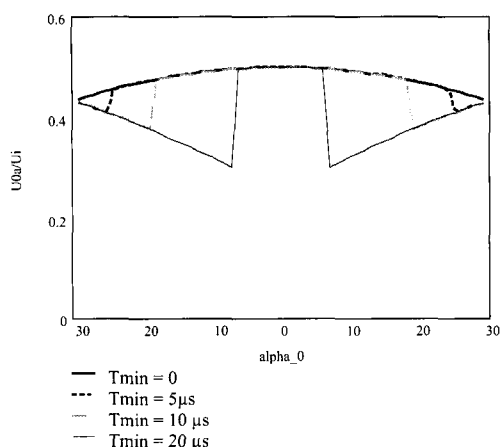

Fig. 17. Error of phase output voltage ($T_p=100\mu s$).

For improving this behaviour two methods can be used:

- 1) the calculated on-times are compensated with help of Eq. (6) to (9), but the direction of the reference input current vector must be neglected.
- 2) the space vector modulation method is replaced by a direct control method similarly the direct torque control (DTC) combined with a direct charge control of the input-filter.

5. Conclusions

Based on the knowledge about load current direction I or/and commutation voltages U different multi step policies were derived. Absent storage elements and the request of small filters leads to high switching frequencies. If U and I are exactly known a commutation is possible in only one step. As a result the control deviation can be reduced as shown for applied space vector modulation.

References

- [1] Sebastian Raith, "The New Built-In Servo drive 'Posmo Si' - an alternative approach to Mechatronics", CIPS 2000, International Conference on Integrated Power Systems, VDE-Tagung, pp. 171~181, Bremen, 2000.
- [2] J. Chang and D. Braun, "High-frequency AC-AC converter using 3-in-1 IBPMs and adaptive commutation", PESC, pp. 351~357, 1999.
- [3] C. Klumpner, F. Blaabjerg, and P. Nielsen, "Speeding-up the maturation process of the Matrix Converter Technology", PESC 2001, Vol. 2, pp. 1102~1107.
- [4] Olaf Simon and Manfred Bruckmann, *Control and Protection Strategies for Matrix Converters*, SPS/IPC/DRIVES, Nürnberg, 2000.
- [5] M. Hornkamp, M. Loddenkötter, M. Münzer, O. Simon, and M. Bruckmann, *Economac the first all-in-one IGBT module for matrixconverters*, PCIM, Nürnberg 19-21, Jun. 2001.
- [6] IXYS Corporation: *Technical Information, High Voltage RBIGBT-Forward and Reverse Blocking IGBT, IXRJH 50N120*, IXYS Corporation, Santa Clara/California, 2000.
- [7] Lazlo Gyugyi, "Generalized Theory of Static Power Frequency Changers", Ph. D thesis, University of Salford, 1970.
- [8] A. Christensson, "Switch-Effective modulation strategy for Matrix Converters", EPE '97, pp. 4.193~4.198, Trondheim/Schweden, 1997.
- [9] Alberto Alesina and Marco Venturini, "Analysis and design of optimum-amplitude nine-switch direct AC-AC converters", IEEE Transactions on Power Electronics, Vol. 4, No. 1, pp. 101~112, 1989.
- [10] Jun Oyama, Tsuyoshi Higuchi, Eiji Yamada, Takashi Koga, and Thomas Lipo, "New control strategy for matrix converter", IEEE PESC, pp. 360~367, 1989.
- [11] N. Burany, "Safe control of 4 Quadrant Switches", IEEE-Industry Application Society, pp.1190~1194, 1989.
- [12] T. Svensson and M. Alakula, "The modulation and control of a Matrix Converter - Synchronous Machine Drive", EPE '91, pp. 4.469~4.476, 1991.
- [13] Marcus Ziegler and Wilfried Hofmann, "Semi-natural two steps commutation strategy for Matrix Converters", PESC, pp. 727~731, Fukuoka/JAPAN, 1998.
- [14] R.R. Beasant, W.C. Beattie, and A. Refsum, "An approach to the realization of a high power Venturini converter", IEEE PESC, pp. 291~297, 1990.
- [15] Folko Heinke and R. Sittig, "The Monolithic bidirectional switch", IEEE ISPSD '00, Toulouse, pp. 237~240, 2000.
- [16] Marcus Ziegler and Wilfried Hofmann, "New one step commutation policies for matrix converters, IEEE PEDS '01, Bali, 22-25 October 2001.
- [17] D. Casadei, G. Grandi, G. Serra, and A. Tani, "Space Vector Control of Matrix Converters with unity Input Power Factor and Sinusoidal Input/Output Waveforms", EPE '93 Proceedings, pp. 170~175, 1993.
- [18] D. Casadei, M. Metteini, et. Al, "Direct Torque Control using Matrix Converters: Improvement of the Input Line Current Quality", EPE '2001, Graz. CD-ROM.



Wilfried Hofmann was born in Dresden, Germany, in 1954 and got his Dipl.-Ing. and Dr. degree in electrical engineering at the TU Dresden in 1978 and 1984, respectively. From 1982-1988 he was with the power electronic company ELPRO in Berlin as researcher and project leader. 1989-1992 he became an associate professor at the department of Automation and Drives at TU Dresden. He has the chair of the Department of Electrical Machines and Drives at Chemnitz University of Technology since 1992. He has published 50 patents and about 120 papers concerning electrical machines and drives, power electronics and motion control.



Marcus Ziegler was born in Hünfeld, Germany, in 1967. He received his diploma in electrical engineering from the University of Technology Darmstadt in 1994. After a year as lecturer he joined the department of electrical machines and drives at Chemnitz University of Technology to investigate commutation policies especially for matrix converters. Three patents and ten papers concerning the topic matrix converter results already.