

Studies on Solvent Sublation of Trace Heavy Metals by Continuous Flow System as Ternary Complexes of 1,10-Phenanthroline and Thiocyanate Ion

Young-Sang Kim,^{*} Yoon-seok Choi,[†] and Won Lee[‡]

Department of Advanced Material Chemistry, Korea University, Jochiwon, Choongnam 339-700, Korea

[†]West Sea Fisheries Research Institute, National Fisheries Research and Development Institute, Incheon 400-420, Korea

[‡]Department of Chemistry, Kyunghee University, Seoul 130-701, Korea

Received April 21, 2003

A continuous flow system has been developed to determine trace Cu(II), Mn(II), Ni(II) and Zn(II) in a large volume of water samples by a solvent sublation technique. The mixed solution of 1,10-phenanthroline(phen) and thiocyanate ion was used as ligands for the formation of their ternary complexes. The continuous system was constructed in this laboratory with a peristaltic pump, a mini shaker, three mixing bottles and a flotation cell by connecting each part with a polyethylene tube. The flotation conditions such as the flow rate of sample solution and the injection rates of ligand, buffer and surfactant solutions have been investigated to obtain the best sublation efficiencies. Each solution flowed into the flotation cell through each polyethylene tube by the peristaltic pumps. The ternary complexes were floated and extracted into MIBK in a flotation cell of 2 L by bubbling a nitrogen gas. The absorbances of extracted analytes in MIBK were directly measured by graphite furnace-AAS. The concentrations of 1,10-phenanthroline and thiocyanate ion were 2.6×10^{-3} M and 2.3×10^{-2} M in the mixed solution, respectively. The pH of sample solution was adjusted to 5.0 with a buffer solution and 1%(m/v) sodium lauryl sulphate solution was added as a surfactant to support the effective flotation of the complexes. The N₂ gas was bubbled at 30 mL/min for 90 minutes for 20 L of sample. Reproducible results of less than 10% RSD and recoveries of 80-120% could be obtained in real samples.

Key Words : Solvent sublation, Trace heavy metals, Continuous flow system, 1,10-Phenanthroline, Thiocyanate ion

Introduction

Solvent extraction,¹⁻³ ion exchange chromatography,⁴ adsorption,^{5,6} precipitation and so on have been widely applied for the separation and concentration of trace constituents. Besides, a flotation technique has been frequently used for this purpose because it has a good advantage to concentrate trace elements with a relatively simple technique. This is classified to precipitation (inorganic⁸ and organic⁹⁻¹²), co-precipitation¹³⁻¹⁵ and ion formation¹⁶ flotations. On the other hand, a solvent sublation was developed as a combined technique of the solvent extraction and flotation technique. Treated analytes such as complex or ion pair are floated by gas bubbling and extracted into an organic solvent on the surface of a sample solution. The solvent should be insoluble in an aqueous solution as well as lighter than water. This solvent sublation can simplify the experimental procedure for the separation and concentration of wanted constituents with a large ratio.^{17,18} In our laboratory, the solvent sublation has been applied to concentrate and determine trace elements in various kinds of water samples.¹⁹⁻²³

But such batch system which can treat 1.0-2.0 L solution for each time is inconvenient and time consuming to analyse a large volume of sample because it should be repeated several times. Therefore a continuous flotation system was developed for the large volume. Mamoru *et al.*²⁴ determined nitrite ion of $\mu\text{g/mL}$ level in water samples by the continuous flotation and UV/Vis spectrophotometry. Mizuike *et al.*²⁵

concentrated trace metallic ions in fresh water and sea water by the continuous method with a very large ratio after the ions were co-precipitated with indium hydroxide. On the other hand, Takahashi *et al.*⁴⁷ developed a method to remove U(VI) ion from water sample by using such flow system. Jeffrey *et al.*²⁶ designed and manufactured a bubble column reactor of pilot scale for the treatment of a waste water by the continuous solvent sublation to separate pyrene and pentachlorophenol.

In this work, a continuous flow system was assembled for the solvent sublation of trace Cu(II), Mn(II), Ni(II) and Zn(II) in water samples by using 1,10-phenanthroline^{39,41} and thiocyanate ion^{34,42-46} as a mixed ligand. And experimental conditions such as the flow rate of sample solution, the pH of buffer solution, the type of surfactant, the flow rate of the mixed ligand solution and so on were investigated for the treatment of a large volume of samples. The analytes which were concentrated in MIBK (methylisobutylketone) was directly determined by GF-AAS. And the usefulness and applicability was evaluated by applying this method to real samples of tap water and river water.

Experimental Section

Reagents and instruments. Analytical grade reagents were used without the further purification and the used water was purified with a Millipore Milli-Q system. Standard solutions of 100 $\mu\text{g/mL}$ Cu, Mn, Ni and Zn were prepared

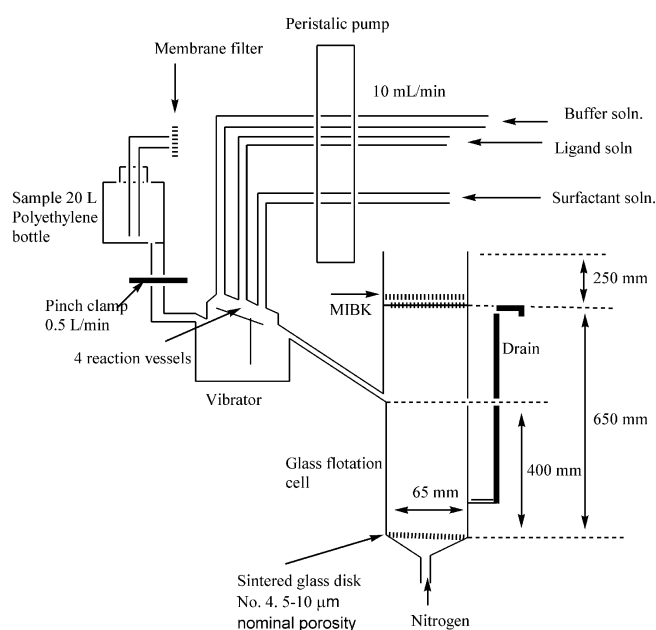

Figure 1. Schematic diagram for continuous flow flotation cell.

with NIST standard solutions and these were used by diluting to optimum concentrations. The mixed ligand solution of 1,000 mL was prepared by mixing 500 mL of 2.60×10^{-3} M 1,10-phenanthroline (Aldrich Co.) ethanolic solution and 500 mL of 2.30×10^{-2} M NaSCN (Shinyo Co.) solution. A 1,000 mL ethanolic solution of 0.1% (m/v) sodium laurylsulfate was used as a surfactant. And a 1,000 mL buffer solution of Na_2HPO_4 and citric acid was used to adjust the solution pH.

A graphite furnace atomic absorption spectrophotometer of Perkin-Elmer model 2380 was used to determine the analyte elements. HGA-400 temperature programmer was equipped and hollow cathode lamps of Perkin-Elmer Co. were used. A pH meter of Tokyo Rikakikai model PHM-2000 was used with Ingold composite glass electrode.

Continuous flow flotation system. This system was

designed to treat several ten liters of sample for the concentration of analytes with a very large ratio (see Fig. 1).

In our system, the flow rate of water sample was controlled with a pinch valve connected to 20 L polyethylene bottle, and the solutions of buffer, mixed ligand and surfactant were flowed into a flotation cell with a peristaltic pump. The sample solution was sequentially mixed with other solutions in four 100 mL polyethylene bottles before the flotation cell. The bottles were shaken on a small vibrator for a thorough mixing. The mixed solution was injected into the middle part of the cell. The ternary complexes of ions formed were floated and extracted into the solvent on the solution continuously by bubbling nitrogen gas through fritted disc of 4 to 10 μm porosity. And the remained solution was drained through a tap on the low part of the cell.

Solvent sublation of analytes. The flow rate of each reagent solution is an important fundamental condition in this continuous system. The peristaltic pump was model SMP-13 of EYELA Co. and the inside diameter of pumping tube was 3.15 mm and outside diameter was 5.20 mm. The flow rate of the pump was fixed at 150 mL/h considering the data given by the manufacturer. And the flow rate of sample solution was controlled at 20 L per 150 minutes by a pinch valve. Such flow rate should be determined under the consideration of complex formation time and analysis time. And the concentrations of buffer, mixed ligand and surfactant solutions were also considered for this. Besides, the bubbling rate of nitrogen gas through the fritted disc must be controlled for the complete sublation of analyte ions. The rate was fixed at 30 mL/min based on our experimental data about the solvent sublation of complexes or ion pairs by the batch process.

A 100 mL of MIBK was added on the sample solution to extract all analytes floated. And the retaining time of reacting solution in the flotation cell was determined by adjusting the height of a drain tube. The analytes concentrated in a solvent was determined by GF-AAS with operating conditions as in Table 1.

Table 1. Instrumental conditions for Perkin-Elmer 2380 GF-AAS and heating programs for HGA-400 graphite furnace

Operating conditions				
	Cu	Mn	Ni	Zn
Wavelength (nm)	324.8	279.5	232.0	213.9
Lamp current (mA)	30	30	30	30
Bandwidth (nm)	0.7	0.7	0.7	0.7
Signal mode	Absorbance			
Inert gas	Argon			
Tube Type	uncoated tube			
Heating programs for graphite tube				
Drying, °C	150, [5], (5)	150, [3], (3)	150, [5], (5)	150, [3], (3)
Charring, °C	800, [5], (5)	900, [3], (3)	1000, [5], (5)	300, [3], (3)
Atomization, °C	2600, [3], (5)	2600, [2], (2)	2650, [3], (8)	1600, [2], (1)
Cleaning, °C	2700, [3], (3)	2700, [3], (3)	2700, [3], (3)	2700, [3], (3)

Sample injection: Cu, Mn, Ni: 20 μL , Zn: 10 μL (solvent: MIBK). []: Holding time, in seconds; (): Ramping time, in seconds

Results and Discussion

Metallic complexes, distribution ratio and extraction percentage. The structure of ternary metallic complex with 1,10-phenanthroline²⁷⁻²⁹ and SCN⁻³⁰⁻³³ was given as one form of follow structures depending on the coordination number of metallic ion^{35,36,37,40}:

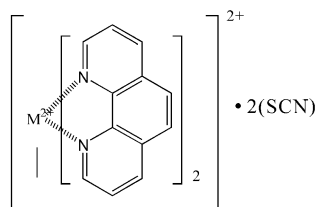

or

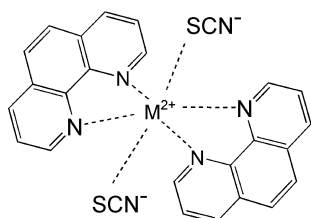

Generally, these four kinds of analyte elements {Cu(II), Mn(II), Ni(II) and Zn(II)} are known to form 1 : 2 chelate with 1,10-phenanthroline ligand^{36,37} mainly, but also 1 : 3 chelates can be formed for Ni(II),^{41,45} Zn(II),⁴² and Mn(II).⁴⁰ An anion, which forms ternary complex, can be bound to the 1,10-phenanthroline chelates additionally depending on the coordination number of metal ion. Halide (Cl⁻, Br⁻, I⁻) and pseudohalide (SCN⁻) ion can be included in such anions. Besides, following complexes can be formed: 1 : 1 chelate of Cu(II) and 1,10-phenanthroline(phen),³⁵ 1 : 2 complex of [M(SCN⁻)₂(phen)₂] for Mn(II), Ni(II) and Zn(II),^{36,38} 1 : 3 type of [M(phen)₃]X⁻³ for Mn(II),⁴⁰ and 1 : 1 complex of [M(phen)](H₂O)_n for Zn(II).⁴¹ Therefore, the general formula of the ternary complexes in this work are presented with [M(SCN⁻)_m(phen)_n]^{2-m+}.

Such ternary metallic complexes of 1,10-phenanthroline and thiocyanate ion (SCN⁻) in an aqueous solution can be extracted into an organic solvent, MIBK, according to following reaction:

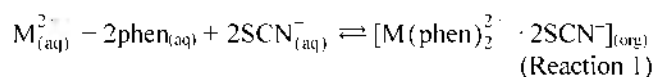

From this reaction, the distribution ratio, D_r , of metal ion can be given with following equation:

$$D_r = \frac{C_{org}}{C_{aq}} = \frac{[M(phen)_2^{2+} \cdot 2SCN^{-}]_{org}}{[M^{2+}]_{aq} + [M(phen)_2^{2+}]_{aq} + [M(phen)_2^{2+} \cdot SCN^{-}]_{aq}} \quad (1)$$

In this equation, C_{org} and C_{aq} were the total concentration of

metal species in an organic and aqueous phase, respectively. But the concentration of metal ion in the aqueous solution is much larger than other species as $[M^{2+}]_{aq} \gg [M(phen)_2^{2+}]_{aq} + [M(phen)_2^{2+} \cdot SCN^{-}]_{aq}$ so that the above equation can be simplified to

$$D_r = \frac{[M(phen)_2^{2+} \cdot 2SCN^{-}]_{org}}{[M^{2+}]_{aq}} \quad (2)$$

This distribution ratio will be helpful for the application of such ternary complex system to the continuous flow solvent sublation. That is, the efficiency of the solvent sublation can be expected with the ratio. But the ratio was obtained using a batch system because a large volume of solution and a long time were needed in the flow system. The concentration of the remained metallic ion in the sample solution was determined by GF-AAS to calculate the ratio at the different pH of the solution under other optimized conditions (see Figure 2).

As shown in the figure, these four metallic complexes were more efficiently distributed in an acidic solution than in a basic solution. The distribution ratio were decreased with the increase of pH. Such decrease in a basic solution can be considered to be mainly due to the competing precipitation of metal hydroxides. That is, the hydroxide precipitation interfered with the formation of the ternary complexes.

Besides, the extraction percentage of the complexes into MIBK was investigated depending on the change of solution pH. A following equation was used for it.

$$E(\%) = 100 \times \left[D_r / \left(D_r + \frac{V_{aq}}{V_{org}} \right) \right] \quad (3)$$

where V_{aq} and V_{org} is each volume of aqueous solution and organic solvent.

The maximum extraction of each element was calculated at the optimum pH: 74% for Cu(II) at pH 3-4, 74% for Mn(II) in the range of pH 4-6, 62% for Ni(II) at pH 3-4 and

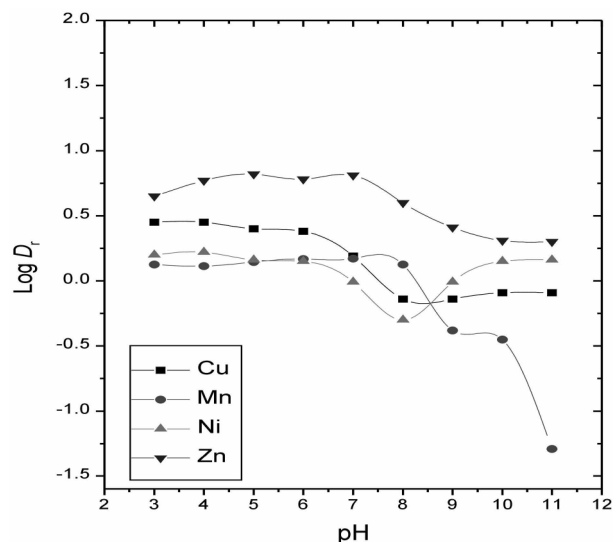

Figure 2. The effect of pH on the distribution of ternary complexes from an aqueous solution to MIBK by a batch system.

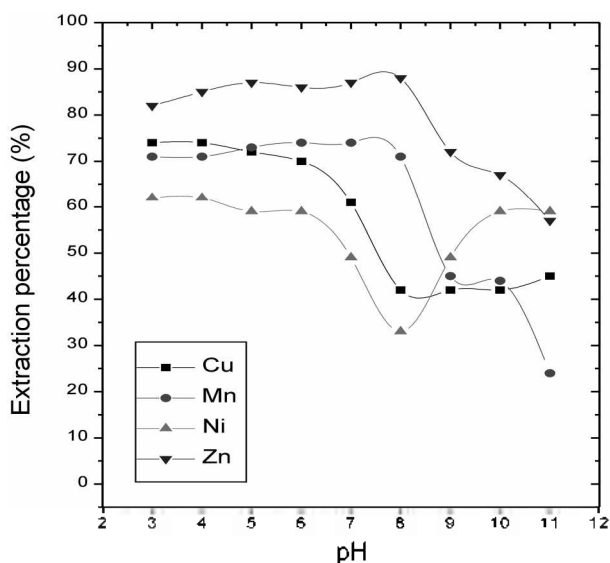

Figure 3. The pH dependency on the extraction percentage of ternary complexes from aqueous solution into MIBK.

86% for Zn(II) in the range of pH 5-7.

Like the case of distribution ratio, the extraction percentages were constant at maximum from pH 3 to 5 for Ni(II) and Cu(II) and to 7 for Mn(II) and Zn(II) as shown Figure 3. Their extraction decreased in the solution at pH higher than corresponding pH. This phenomena are considered to be due to the competition of hydroxide precipitation toward complex formation of analyte ions.

pH of buffer solution. The pH of the buffer solution should be carefully adjusted because several liters of sample solution is analysed by the solvent sublation of continuous flow system. That is, the pH of a large volume of sample solution is maintained at a constant value by calculating the buffer capacity. The buffer solution of Na_2HPO_4 and citric acid was used in this work to be applied to tap, natural and

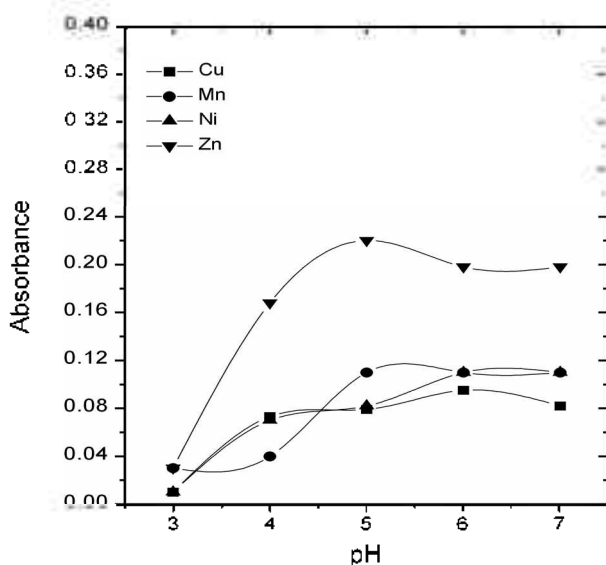

Figure 4. The effect of pH on ternary complexes formation for the solvent sublation by a continuous flow system.

ground water as a real sample.²⁵ The buffer solution of pH 3 to 7 was prepared by changing the used amount of Na_2HPO_4 and citric acid. And this buffer was flowed at 150 mL/h by the peristaltic pump. The results were shown in Figure 4.

As in Figure 4, the constant absorbance was shown from pH 5.0 for Mn(II) and Zn(II) and from pH 6.0 for Cu(II) and Ni(II). At lower pH than them, the donation power of lone electron pair in 1,10-phenanthroline is decreased due to bonding with H^+ ion so that the bonding strength between metallic ion and ligand is also weakened in the complex. Further more the bond can be dissociated.^{28,29} Therefore the pH was fixed at 6.0 in this work. The 1.0 L buffer solution of 0.3 ionic strength was prepared by dissolving 34.2 g Na_2HPO_4 and 10.83 g citric acid according to the manual in a handbook.

Type and amount of surfactant. Usually a surfactant is used to float such complexes to the surface of sample solution effectively.¹⁹⁻²⁵ The role of the surfactant in this case is to float the material of complex or precipitate to the surface of an solution by foams after the surface of floating material is changed from hydrophilic to hydrophobic. Also the foams of surfactant support the floated material and prevent the redistribution so that the flotation efficiency increases for the effective sublation.

In this work, the best surfactant was determined for the effective flotation of the ternary complexes after four metallic complexes were formed under optimum other conditions. As already described, the solvent sublation is the technique to extract complexes into a solvent on the surface of sample solution. Therefore, a surfactant to float complexes effectively is the best one. The sublation efficiency of metal complexes was investigated for several cationic, neutral and anionic surfactants using an aqueous solution of given concentrations of analyte elements. Of course this experiment was performed under other optimum conditions (see Figure 5).

As shown in the figure, the flotation efficiency increased in the addition of anionic Sodium laurylsulfate(SLS) and

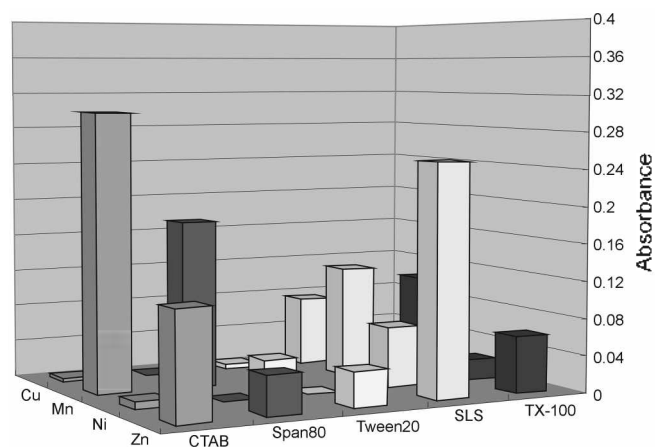

Figure 5. The comparison of solvent sublation efficiencies by the continuous flow system according to various surfactants. CTAB: cetyltrimethylammonium bromide, SLS: sodium lauryl sulfate, TX-100: Triton X-100, Tween 20: polyoxyethylene sorbitan monolaurate, Span 80: sorbitan monooleate.

neutral TX-100 for Cu(II) complex. SLS and neutral Span 80 for Ni(II) and SLS for Zn(II). Such phenomena were considered to be due to neutral or positive charge of four or six coordinated complexes.^{35,40,43-45} On the other hand, the effective flotation was shown in the addition of cationic CTAB for Mn(II) complex. This is because of high possibility to form the anionic four coordinated complex of Mn(II) with SCN⁻ ion.³⁸⁻⁴⁰ But a surfactant which can form a stable foams at the interface between the aqueous and organic phases should be selected in the continuous flow system in order to concentrate simultaneously and determine four elements of Cu(II), Mn(II), Ni(II) and Zn(II). Therefore SLS was used as a surfactant. SLS can make stable foams and give a good flotation efficiency.

The surfactant solution of 0.2%(m/v) SLS solution was prepared at an initial time based on our batch experiences which have done up to now. But a large volume and the continuous outflow of the sample solution should be considered in the continuous flotation system so that it was difficult to optimize the condition about the surfactant solution. In several preliminary experiments, it was known that 0.01% SLS solution was not enough to get the best flotation efficiency at the injection rate of 500 to 520 mL per 150 minutes. This injection rate was similar to the buffer solution. Therefore, the concentration of the surfactant was optimized from the experiment done with 0.01, 0.05, 0.1, 0.5, 1.0 and 2.0% SLS solutions. The maximum flotation efficiency was shown from 0.5% at the above injection rate. Too many foams were formed with 2.0% solution to be overflowed in the flotation cell at the injection rate. 1.0% SLS solution was used in this work.

Organic solvent. In this continuous flotation system, the complexes floated by an aid of nitrogen bubbles are extracted into an organic solvent on the surface of sample solution. Therefore the solvent should be lighter than an aqueous solution and have a small volatility to keep a constant volume until AAS measurement.²⁵ Besides, it should have a large partition coefficient to extract the complex effectively and not give a low background for the

direct absorbance measurement of analytes in the organic solution.

In this work, the best solvent was selected from the results of solvent sublation of analytes by the continuous flotation method using benzene, cyclohexane, *m*-xylene, MIBK and octane of the density from 0.75 to 0.90 g/mL (Figure 6). This investigation was done under other optimum conditions. As shown in the figure, the largest absorbance was given with octane for Mn(II) and benzene for Zn(II). But MIBK was chosen as an optimum solvent because it showed good absorbances for 4 kinds of analytes.

Analytical results. After the conditions of solution flow and flotation were optimized in the continuous flow system, the usefulness of this procedure was evaluated by the application of this system to the analysis of real water samples. A series of standard solutions were prepared by adding given concentrations of analytical elements to 20.0 L

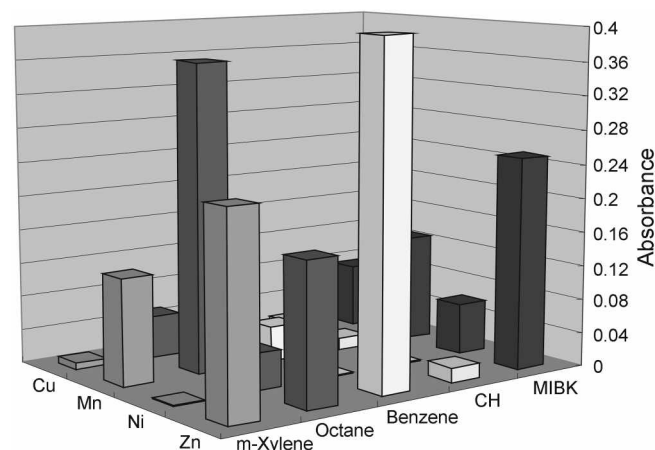

Figure 6. Sublation efficiencies according to the type of solvent with continuous flow system. MIBK: methylisobutyl ketone. CH: Cyclohexane.

Table 2. Analytical results of analytes in real samples by a solvent sublation (Unit ng/mL)

Sample	Elements Spiked	Measured	Recovered ^d	RSD (%)	Recovery (%)
Tap water	Cu(II)	0.00	15.97		6.23
		2.00	18.14	2.17	5.54
	Mn(II)	0.00	0.47		6.04
		0.80	1.23	0.76	5.62
	Ni(II)	0.00	0.32		4.14
		2.00	2.66	2.34	9.02
	Zn(II)	0.00	0.31		3.21
		0.80	1.04	0.73	8.21
^a Kobok reservoir water	Cu(II)	0.00	11.72		3.14
		2.00	14.06	2.34	2.74
	Mn(II)	0.00	0.34		3.20
		0.80	1.02	0.68	3.44
	Ni(II)	0.00	0.28		8.18
		2.00	1.88	1.60	1.94
	Zn(II)	0.00	0.09		1.41
		0.80	1.02	0.93	7.76
^b Miho-chun water	Cu(II)	0.00	47.01		1.41
		2.00	48.81	1.80	3.44
	Mn(II)	0.00	0.26		7.47
		0.80	0.90	0.64	3.94
	Ni(II)	0.00	0.67		4.54
		2.00	2.28	1.61	8.70
	Zn(II)	0.00	0.37		2.97
		0.80	1.30	0.93	2.12
Commercial mineral water	Cu(II)	0.00	5.88		9.76
		2.00	8.03	2.15	1.90
	Mn(II)	0.00	2.45		4.79
		0.80	3.24	0.79	3.61
	Ni(II)	0.00	1.06		4.57
		2.00	2.88	1.82	8.25
	Zn(II)	0.00	0.15		3.43
		0.80	1.12	0.97	3.95

^aan irrigation reservoir near Seochang Campus of Korea University, ^ba small river around Seochang Campus of Korea University, ^dmeasured values minus determined values.

of a deionized water and the elements were separated and extracted into MIBK by the continuous flow solvent sublation under the optimized conditions. The absorbances of the elements were measured in the solvent by GF-AAS. And the measured absorbances were used to make calibration curves for four elements of Cu(II), Mn(II), Ni(II) and Zn(II). The curves were excellently linear with the linearity of more than 0.98. The plotted curves were used for the determination of four analyte elements in four kinds of water samples. And the recoveries of analytes in spiked sample solutions were shown with the analytical results (Table 2). The recoveries were ranged from 80 to 120% and the relative standard deviations were less than 10% for the analytical results of 3-5 measurements. For these results, it could be concluded that the proposed continuous flow flotation system was applied to the determination of trace elements in water samples.

Conclusion

A continuous flow flotation system was designed and constructed in our laboratory. Ultra trace Cu(II), Mn(II), Ni(II) and Zn(II) could be subluted as the ternary complexes of 1,10-phenanthroline and thiocyanate into MIBK. The analytes were concentrated with the large ratio of 200 from a large volume of water samples to be determined by graphite AAS. The complexes and ion pairs were effectively formed at around pH 5.0 and the flotation efficiency was increased by adding 1.0% solution of sodium lauryl sulfate detergent. Less than 10% RSD for all analytical results and the recoveries of 80 to 120% in spiked samples showed that this procedure could be applicable to ultra trace analysis of water samples.

Acknowledgement. This work was supported by KOSEF with the project number of 1999-1-124-001-3. The support was sincerely acknowledged by authors.

References

- Ohmiya, Y.; Kim Dung, N. T.; Sekine, T. *Bull. Chem. Soc. Jpn.* **1997**, *70*, 1867.
- Bazel, Y. R.; Studenyak, Y. I.; Tolmachev, A. A. *J. Anal. Chem.* **1997**, *52*, 603.
- Thakur, P.; Chakravorty, V.; Reddy, M. L. P. *Radiochim. Acta* **1999**, *87*, 121.
- Anezaki, K.; Chen, X.; Ogasawara, T.; Nukatsuka, I.; Ohzeki, K. *Anal. Sci.* **1998**, *14*, 523.
- Tagashira, S.; Murakami, Y.; Nishiyama, M.; Harada, N.; Sasaki, Y. *Bull. Chem. Soc. Jpn.* **1996**, *69*, 3195.
- Saitoh, T.; Ohyama, T.; Takamura, K.; Sakurai, T.; Kaise, T.; Matsubara, C. *Anal. Sci.* **1997**, *13*, 12.
- Kim, Y. S.; Kim, K. C.; Lee, C. W. *Bull. Korean Chem. Soc.* **1999**, *20*, 431.
- Nakashima, S. *Anal. Chem.* **1979**, *51*, 654.
- Dong, H.; Yang, S.; Liu, J. *Anal. Sci.* **1989**, *5*, 601.
- Hiraide, M.; Mizuike, A. *Bull. Chem. Soc. Jpn.* **1975**, *48*, 3753.
- Hiraide, M.; Mizuike, A. *Talanta* **1974**, *22*, 539.
- Edward, A. B.; John, M. E. *Anal. Chim. Acta* **1977**, *91*, 189.
- Motomizu, S.; Oshima, M.; Araki, K. *Analyst* **1990**, *115*, 1627.
- Nakashima, S.; Yagi, M. *Anal. Chim. Acta* **1983**, *147*, 213.
- Nakashima, S.; Yagi, M. *Anal. Chim. Acta* **1984**, *157*, 187.
- Koide, Y.; Terasaki, H.; Sato, H.; Shosenji, H.; Yamada, K. *Bull. Chem. Soc. Jpn.* **1996**, *69*, 785.
- Jacob, E.; Barry, L. K. *Anal. Chem.* **1969**, *41*, 671.
- Cervera, J.; Cela, R.; Perez-Bustamate, J. A. *Analyst* **1982**, *107*, 1425.
- Kim, Y. S.; Shin, J. H.; Choi, Y. S.; Lee, W.; Lee, Y. I. *Bull. Korean Chem. Soc.* **2001**, *22*, 19.
- Kim, Y. S.; Shin, J. H.; Choi, Y. S.; Lee, W.; Lee, Y. I. *Microchemical J.* **2001**, *68*, 99.
- Kim, Y. S.; Choi, Y. S.; Choi, H. S. *Bull. Korean Chem. Soc.* **1998**, *19*, 1036.
- Kim, Y. S.; Jung, Y. J.; Choi, H. S. *Bull. Korean Chem. Soc.* **1998**, *19*, 50.
- Kim, Y. S.; Choi, Y. S.; Lee, W.; Lee, Y. I. *Bull. Korean Chem. Soc.* **2001**, *22*, 821.
- Aoyama, M.; Hobo, T.; Suzuki, S. *Anal. Chim. Acta* **1982**, *141*, 427.
- Mizuike, A.; Hiraide, M.; Mizuno, K. *Anal. Chim. Acta* **1983**, *148*, 305.
- Jeffrey, S. S.; Kalliat, T. V. *Ind. Eng. Chem. Res.* **1997**, *36*, 903.
- Yajima, S.; Hasegawa, Y. *Bull. Chem. Soc. Jpn.* **1998**, *71*, 2825.
- Robertis, A. D.; Foti, C.; Gianguzza, A.; Rigano, C. *J. Solution Chem.* **1996**, *25*, 597.
- Sun, H.; Lin, H.; Zhu, S.; Zhao, G.; Su, X.; Chen, Y. *Polyhedron* **1999**, *18*, 1045.
- Fukushima, N.; Iisaka, G.; Saito, M.; Waizumi, K. *Inorg. Chim. Acta* **1997**, *255*, 211.
- Mondal, N.; Mitra, S.; Gramlich, V.; Ghodsi, S. O.; Malik, K. M. A. *Polyhedron* **2001**, *20*, 135.
- White, C. A.; Yap, G. P. A.; Raju, N. P.; Greedan, J. E.; Crutchley, R. J. *Inorg. Chem.* **1999**, *38*, 2548.
- Lu, T. H.; Tahirov, T. H.; Liu, Y. L.; Chung, C. S.; Huang, C. C.; Hong, Y. S. *Acta Cryst. - Cryst. Struct. Communication* **1996**, *52*, 1093.
- Ramadan, A. M.; Elnaggar, M. M. *J. Inorg. Biochem.* **1996**, *63*, 143.
- Zhao, J.; Song, B.; Saha, N.; Saha, A.; Gregan, F.; Bastian, M.; Sigel, H. *Inorg. Chim. Acta* **1996**, *250*, 185.
- Komiya, M.; Yoshida, S.; Ishiguro, S. *J. Solution Chem.* **1997**, *26*, 997.
- Yoo, K. S. *Chelating Reagents*, Dong-Myung Press: Seoul, Korea, 1979; p 227.
- Yilmaz, V. T.; Yilmaza, F.; Topcu, Y.; Andac, O.; Guven, K. *J. Mole. Struc.* **2001**, *560*, 9.
- Yang, C. L.; Chen, X. G.; Qin, J. G.; Yakushi, K.; Nakazawa, Y.; Ichimura, K. *J. Solid State Chem.* **2000**, *150*, 281.
- Ramalakshmi, D.; Reddy, K. R.; Padmavathy, D.; Rajasekharan, M.; Arulsamy, N.; Hodgson, *Inorg. Chim. Acta* **1999**, *284*, 158.
- Sen, S.; Mitra, S.; Kundu, P.; Saha, M. K.; Kruger, C.; Bruckmann, J. *Polyhedron* **1997**, *16*, 2475.
- Kurihara, M.; Ozutsumi, K.; Kawashima, T. *J. Solution Chem.* **1995**, *24*, 719.
- Cherni, S. N.; Driss, A.; Jouini, T. *Acta Cryst.* **1999**, *55*, 1248.
- Zhang, C.; Yu, K.; Wu, D.; Zhao, C. *Acta Cryst.* **1999**, *55*, 1815.
- Suescun, L.; Momburu, A. W.; Mariezcurrena, R. A. *Acta Cryst.* **1999**, *55*, 1991.
- Choi, Y. S.; Choi, H. S.; Kim, Y. S. *J. Korean Chem. Soc.* **1998**, *41*, 36.
- Takahashi, M.; Hayashi, M.; Yoshioka, N.; Tanimoto, T.; Takeuchi, H. *Nippon Kagaku Kaishi* **1996**, *9*, 812.