

# The Effects of Cognitive Conflict on Students' Conceptual Change in Physics

Youngjick Lee · Jaesool Kwon

(Chungnam Science High School) · (Korea National University of Education)

## ABSTRACT

The purpose of this study was to investigate the relation between the levels of cognitive conflict and students' conceptual change. In this study, 30 Korean high school students were selected from 450 10th graders by examining the pretest results. Two different strategies were used to induce cognitive conflicts in students, an anomalous or conflict situations; demonstrations and logical arguments against students' preconception. After arousing the students' cognitive conflict, the level of cognitive conflict was rated. Pretest, post-test and delayed post-test were administered to check the conceptual change. The tests consisted of 5 items in mechanics and electricity, respectively. Therefore, the demonstration method showed effective conceptual change, more than the logical argument method did. Students changed their conceptions more easily and frequently in the area of mechanics than in electricity. Students who showed higher levels of cognitive conflict indicated more positive conceptual change than those who showed lower conflict levels. 59 cases (56%) out of 105 who experienced high levels of cognitive conflict were changed into scientific conceptions one month later; however only 16 cases (35%) out of 46 who experienced low levels of cognitive conflict changed into scientific conceptions. Students who experienced higher levels of cognitive conflict showed higher rates of conceptual change. It could be concluded that designing instruction to induce cognitive conflict is a useful strategy to promote conceptual change.

**Key words:** cognitive conflict, conceptual change, misconception

## I. Introduction

Piagetian ideas on cognitive development have influenced education world wide. As a matter of fact, in Korea, Piagetian theory remains one of the most influential theories in science education today. However, since most research related to Piaget has concentrated on his theory of cognitive development, his ideas concerning cognitive conflict have not been given much attention. In more recent times, with the rise of constructivist views and theories on conceptual change(Hewson & Hewson, 1984; Kwon, 1989; Niaz, 1995; Posner, Strike, Hewson & Gertzog, 1982), his ideas on cognitive disequilibrium (another name for cognitive conflict) are attracting

the attention of researchers.

Researchers in science education have been interested in understanding students' conceptions of various scientific areas, along with the processes of conceptual changes. In particular, students' preconceptions are extremely resistant to instructional change, with some students persisting in their misconceptions even after an extensive amount of instruction(Hashweh, 1986; Hewson, 1981; Lee & Kwon, 1992; Thijs, 1987).

Since then, the major concern of science educators has been how to change students' misconceptions of scientific concepts. So, various theoretical models and instructional situations have been developed to facilitate conceptual change, and many researchers have emphasized the importance of cognitive conflict.(Dreyfus, Jungwirth, & Elievitch 1990; Druyan, 1997; Kwon, 1992; Strike & Posner, 1985).

One means of inducing cognitive conflict experiments is to present information which contradicts an individual's view of reality. Such information may be presented as a verbal representation, visual representation, kinesthetic experience or some other form, with provision for direct confrontation between the individual's thinking and the conflicting material. In this study, logical arguments as verbal representations, and demonstrations as visual representations, were used. These methods have often been used in class by the author.

Whenever students are confronted with an incongruous event where they cannot explain certain phenomena using their own pre-existing conceptions, cognitive conflicts are not always induced. Some students experience a high level of conflict, however, while some students experience a low level of conflict. Therefore, this paper intended to examine the effectiveness of the level of the cognitive conflict experienced by a student on conceptual change.

Instructional strategies that use cognitive conflict as a mechanism to effect change in students' conceptions seem very important to conceptual change. However, there is a lack of evidence that could support the claim that these strategies are effective.

The purpose of this study was to develop reliable methods for estimating levels of cognitive conflict and to find relationships between these levels of cognitive conflict and change in students' conceptions.

However, reliable methods for measuring the level of cognitive conflict are not yet reported in the science education literature. In this study, levels of cognitive conflict were estimated quantitatively, and then used to determine the effect of the conflict level on students' conceptual change.

## **II . Background on cognitive conflict**

### **1. Philosophical background**

The origin of the idea of conceptual change may date back to the time of Aristotle. Aristotle proposed that no universal concepts are independent of the objects they represent. In effect, this

was a criticism of contemporary views of knowledge, Plato's theory of eternal ideas, with Aristotle arguing that there was no need to postulate any eternal substance. The discussion on conceptual change continued with Descartes, Locke, Berkeley, Hume, Kant, Hegel and many other philosophers. Among them, it seems worth mentioning Hegel's idea on dialectics that became the basis of Marx dialectical materialism. According to the dialectic theory of Marx, an idea changes through thesis - antithesis - synthesis. Competition between ideas that are represented by thesis and antithesis seem closely related to the notion of cognitive conflict that was of interest to us in this way.

On the other hand, Karl Popper's falsificationism is a more naive version of cognitive conflict strategy. Popper proposed that a scientific theory is to be discarded when new evidence no longer supports an existing theory. However, his idea of falsification does not agree with historical evidence. There are many occasions throughout the history of science when ideas or theories were not discarded due to discrepant observations or anomalous data. Instead, the discrepant evidence was usually rejected, and the original theory retained, in spite of the appearance of anomalies.

Thomas Kuhn(1970) put it differently. Kuhn's theory of scientific revolution is one of the most powerful philosophical backgrounds for the cognitive conflict strategy. In his most influential work, *The Structure of Scientific Revolution*, Kuhn examined the nature of change in scientific thought as his basic problem. Kuhn concluded from his interpretation of the history of science that change in scientific theories is a revolutionary process. His main idea was that development of scientific theory by reduction, (or by falsification), is incompatible with what actually occurred in the history of science, and so it must be reconsidered.

If scientific change is fundamentally revolutionary, there must be non-revolutionary periods as well. Kuhn called these periods of non-revolutionary science, normal science. During periods of normal science, the scientific community shared firm answers to questions, and did not allow fundamental challenges against an existing theory. Another characteristic of normal science was that all evidence contradictory to a theory was regarded as an exception. However, this attitude could change as the number of exceptions increased, eventually leading to a crisis. In a period of a crisis, scientists had more freedom to criticize existing theories than in periods of normal science. In this period, researchers could resolve the crisis by discarding existing theories, and inventing a new theory that is revolutionary. Of course, this can not occur unless an alternative theory is available and capable of competing with the older theory. In sum, according to Kuhn's scientific revolution, a scientific knowledge undergoes the following stages leading to change:

pre-science → normal science → crisis → revolution → new normal science

The portrayal of a Kuhnian paradigm shift presented here is a shortened version of Kuhn's whole arguments on theory change. An old theory does not fall due to a single piece of discrepant evidence. Kuhn's theory assumes that a period of crisis should precede a revolution,

and that crisis comes from significant discomfort with the existing theory. The discomfort comes in part from confronting discrepant evidence. Therefore, cognitive conflict between competing theories is a necessary condition for inducing the crisis that is prerequisite to theory change.

In addition to Kuhn's theory, Lakatos' research program also emphasizes that conflict contributes to theory change. However, he proposed that competition between old and new theories results in destruction of the old theory.

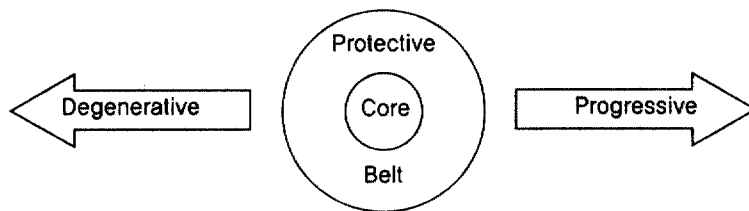

Fig. 1. Lakatos' idea of the progressive and degenerative nature of a theory

According to Lakatos, a mere cognitive conflict does not guarantee conceptual change. For a conceptual change to occur, a rival theory must be available to the learner. Through competition between the old and new core of competing theories, the old theory is replaced when the new theory is judged to be progressive while the old theory is not (Latos & Muszarve, 1974). Even though Lakatos' idea is different from Kuhn's in the way that theories change, they both recognize the importance of cognitive conflict to change in a theory.

## 2. Psychological background

From a psychological basis cognitive conflict strategy might date to the time of Socrates. Socratic dialogue is a method of triggering cognitive conflict that intends to persuade one's opponents. However, a more direct basis for cognitive conflict is found in Piaget's theory on cognitive developmental processes. Piaget called this conflict disequilibrium rather than cognitive conflict. These two terms have exactly the same psychological meaning. Piaget said that a cognitive structure (i.e., an organized knowledge structure in the brain) interacts with the environment by assimilation and accommodation. If assimilation and accommodation occur freely, the cognitive structure is said to be in equilibrium with the environment. However, if this is not the case for an individual, he or she is said to be in a state of disequilibrium. When a learner experiences disequilibrium, he or she will try to change this state to reach equilibrium with the environment. Piaget called this process, equilibration.

The process of cognitive equilibration is not well understood at the present time. However, Flavell(1977) summarized Piaget's cognitive developmental process in the following: (1) cognitive equilibrium at a lower developmental level; (2) cognitive dis-equilibrium, or conflict

induced by awareness of contradictory, discrepant, “non-assimilable” data not previously attended to; and (3) cognitive equilibration (or re-equilibration) at a higher developmental level caused by re-conceptualizing the problem in such a way as to harmonize what had earlier been seen as conflicting. This means cognitive disequilibrium, or cognitive conflict, is a prerequisite, if new equilibration is to occur.

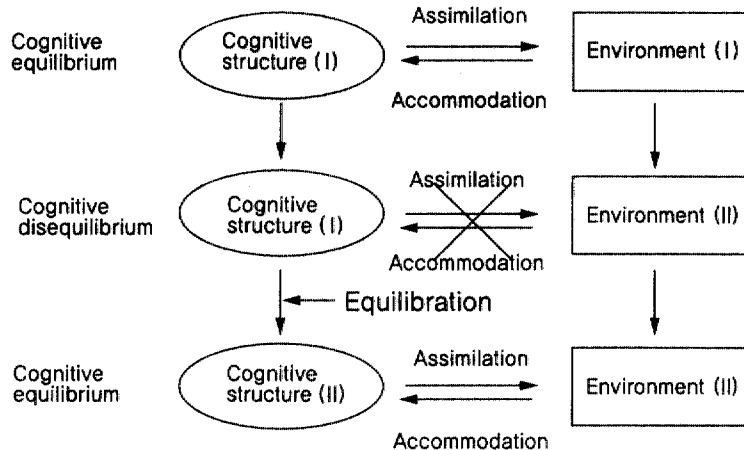

Fig. 2. Piaget's cognitive developmental process (Kwon, 1989)

### 3. Three kinds of cognitive conflict

The Piagetian cognitive disequilibrium, or cognitive conflict, is a kind of imbalance between one's cognitive structures, and the environment. In other words, it is an imbalance between internal structures and external inputs. However, cognitive conflict could also appear without an external input if a learner examined his or her own cognition without a stimulus from the environment. In this case, the cognitive structure is regarded as an object of metacognition. Hashweh (1986) suggested a different kind of cognitive conflict, called metacognitive conflict, which is a conflict between cognitive schemata. This metacognitive conflict would be essential to reach a unified internal structure.

In addition to these two kinds of cognitive conflicts, Kwon (1989) suggested a third kind of cognitive conflict, depicted in the following diagram.

Fig. 3 is a modified version of a diagram originally presented by Hashweh (Hashweh, 1986). The upper sections of Fig. 3 illustrate cognitive structures, and the lower section are stimuli from the environment. C1 represents a student's preconception which in a typical classroom situation would most likely be a misconception. C2 represents the scientific conception to be learned. R1 represents an environment that could be well explained by C1, while R2 is any environment

explained only by C2. R1 and R2 do not represent only one single external phenomenon, but the entire set of observations and stimuli from one's environment.

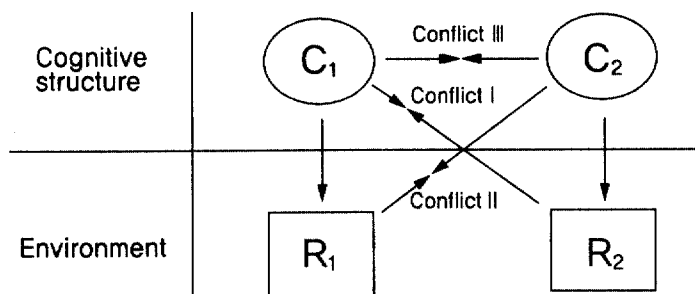

Fig. 3. Kwon's cognitive conflicts model (Kwon, 1989)

The type of cognitive conflict represented in Piaget's thinking is conflict between C<sub>1</sub> and R<sub>2</sub> (labeled Conflict I in Fig. 3). On the other hand, the type of cognitive conflict represented by Hashweh's thinking is between C<sub>1</sub> and C<sub>2</sub> (labeled Conflict III in Fig. 3). However, in the diagram, one may also recognize another kind of cognitive conflict between C<sub>2</sub> and R<sub>1</sub>. Kwon proposed this as another kind of cognitive conflict (Conflict II). One may argue that this is just a version of Conflict I, since Conflict I and Conflict II include all of the cognitive conflicts that occur between a cognitive structure and the environment. While this may be correct in a logical sense, for instructional purposes, recognizing Conflict II as a different type of conflict is useful. Under classroom instruction, such as when a teacher designs a new lesson, these types of cognitive conflicts function differently when instructional decisions are being made, particularly regarding the time allocated to activities. Therefore, to categorize Conflict II as an independent type of cognitive conflict is meaningful.

### III. Methodology

#### 1. Subjects

In this study, 33 Korean high school students were selected from a pool of 450 10th graders. Of the 70 students who selected by selection rule, 33 agreed to participate. Of the original 33 students, 30 completed all activities associated with the study. Subjects selected for the study were chosen based on their reasoning on a pretest, and the number of the misconceptions. Their reasoning on a pretest related to their understanding of the meaning of test items, responding to logical reasoning and answering all items. The number of misconceptions in mechanics and electricity was over half because demonstrations and logical arguments might be suggested similarly. Subjects selected for the correct choice could not induce cognitive conflict by the demonstration method.

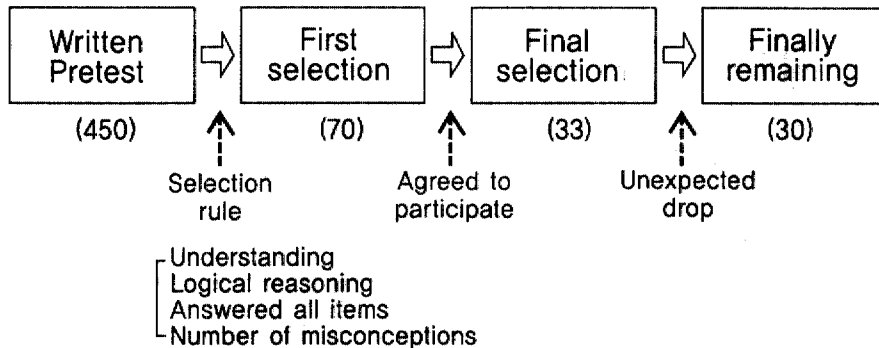

Fig. 4. Subjects selection procedure

## 2. Pre-test and Post-test

For this study, items that satisfied the conditions for conceptual change suggested by Posner were selected. Posner *et al.*(1982) suggested that learners must become dissatisfied with their existing conceptions, as well as find new concepts intelligible, plausible, and fruitful, before conceptual change occurs. To check the students conceptual changes, pretest, post-test, and delayed post-test were conducted. Each test consisted of 10 items (or situations) in mechanics and electricity, respectively. The topic and number of test items for the mechanics test were linear inertia (1), curvilinear inertia (2), action and reaction in a spring (3), equilibrium in a pulley system (4), and action and reaction between two magnets (5). Test items for electricity included two bulbs in series (1), one bulb versus two bulbs in series (2), bulbs in parallel (3), a bulb and a resistor in series (4), and a bulb and a resistor in parallel (5). The same test was used with all subjects for the pretest, post-test, and delayed post-test conducted one month following instruction.

## 3. Presentation of anomalous situation

To generate cognitive conflict, an anomalous situation was presented to the students. First, students observed a demonstration presented by the teacher - the demonstration method. The demonstration method is simple and straight forward. Demonstrations were conducted in front of the students by showing them actual phenomena. All of the students observing the demonstrations had misconceptions of the phenomenon and gave wrong predictions of the result. This is not surprising since all of the students chosen for the study showed misconceptions on the pretest. The demonstration technique we used is in line with the belief that there must be some cognitive conflict before an unscientific conception can change. All demonstrations of physics principles were conducted in a way to arouse cognitive conflict for the students.

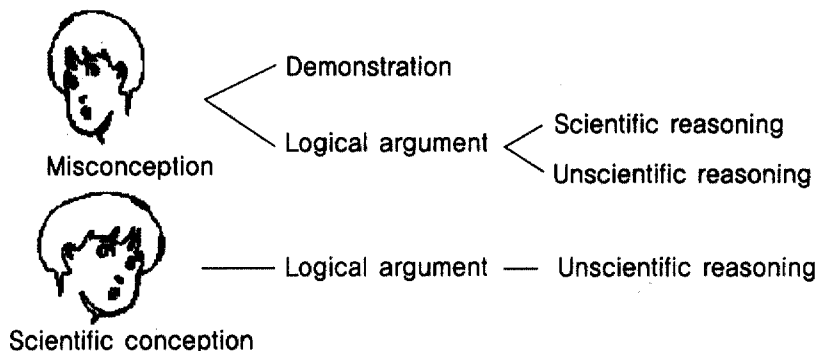

Fig. 5. Presentation of anomalous situations

Second, students were asked to predict the result of a situation presented to them orally, rather than through demonstration by the teacher - the logical argument method. The logical argument method was also designed to elicit cognitive conflict. Through this method, students were presented with concepts that were understandable, plausible, and useful in terms of their lines of logic. Each logical argument disproved the students' predictions for a given situation. That is, logically consistent scientific arguments were given to students who predicted an incorrect result, and scientifically incorrect, but seemingly logical arguments were given to students who predicted a correct result.

#### 4. Rating scheme of cognitive conflict

The level of the cognitive conflict experienced by a student was measured with a checklist during a structured interview. Fig. 6 shows the categories of cognitive conflict and rating scheme included on the checklist. The responses of students in a state of conflict were first divided into two categories, according to acceptance or rejection of the new conception. For instance, the response of a student who changed his or her prior conception to the new conception was placed in the "Yes" group (acceptance). Responses from students who retained prior conceptions were placed in the "No" group (rejection). Each group was further divided into two categories according to whether the students reasoning was judged to be critical or non-critical. In the Yes group, any student who stated critical reasons for the acceptance of a new conception was included in the critical acceptance category. However, the response of a student who did not readily suggest reliable reasoning for the acceptance of a new conception was placed in the non-critical acceptance category. Placement of individuals within the No group was carried out in the same way as in the Yes group.

Student conflict scales were rated from 0 to 3, according to the degree of a student's response. For instance, while a critical response was rated as a high level of conflict (2-3), non-critical



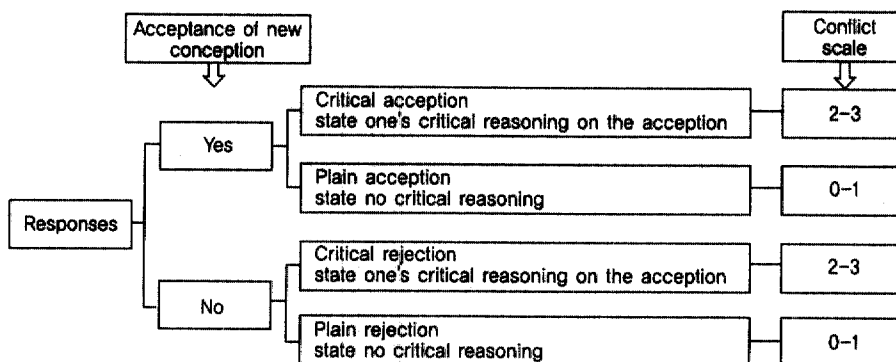

Fig. 6. Categories of cognitive conflict and rating scheme

responses were rated as a low level of conflict (0-1). To improve the reliability of these ratings, students were asked to rate their responses to these categories, too. A comparison between the ratings by the interviewers, and those by students, showed a high correlation. In cases where disagreement occurred, if the response of a student was consistent and had validity throughout the interview, the interviewer's rating was modified to meet the student's assessment. In a pilot study, a panel of three independent researchers also rated each student's level of conflict during situation identical to those above. This panel practiced rating several times in order to reliably rate all subjects. The panel raised the Kendall's inter-rator agreement coefficient to .85.

Examples of cognitive level estimation, both in the demonstration and the logical argument situations, are presented in the excerpts from interview data presented below.

### 1) Demonstration

The following examples show two different levels of cognitive conflict from a demonstration. One student, (#14), was judged to have a low level of conflict, while the other, (#6), was judged to have a high level of conflict.

Student #14

Teacher: [Asks the student to explain an answer on the pretest.]

Student #14: In (A), the current flowed first.

Teacher: Would you show it?

Student #14: Yes [Student moves demonstration materials around].

Teacher: Your thoughts now are different from the demonstration. You may feel strange and conflicted by this. Would you mark the degree of conflict which is your feeling of strangeness or confusion?

Student #14: [marked at 1]

Teacher: Why?

Student #14: The moment I switched on the circuit, the many bulbs of a Christmas tree flashed in my mind and I thought the brightness of each bulb would be the same. So, I did not feel a deep conflict.

The response from this student was placed into the non-critical acceptance category, since Student #14 did not give any critical arguments as to his acceptance of the new idea demonstrated by the teacher.

Student #6

Teacher: [Asks the student to explain an answer on the pretest.]

Student #6: The current going through at (A) was weakened.

Teacher: Would you show it?

Student #6: Yes (The student examines the demonstration materials and points his fingers this way and that. His face expressed a state of agony.)

Teacher: Your thoughts now are different from the demonstration. You may feel strange and conflicted by this. Would you mark the degree of conflict which is your feeling of strangeness or confusion?

Student #6: [marked at 3]

The thoughts and expressions from Student #6 indicated that he experienced conflict as a result of the demonstration. He made uncomfortable facial gestures indicating he was uncomfortable with his ideas throughout the interview, and tried to verify his idea that the brightness of the bulb should change.

## 2) Logical arguments

The following examples show two different levels of cognitive conflict that emerged during the logical argument situation. One student, (#9), showed a low level of conflict, and the other, (#11), showed a high level of conflict.

Student #9

Teacher: [Asks the student to explain an answer on the pretest.]

Student #9: I thought of the bulb as a resistance. (A) had one resistance while (B) had two. So I thought (A) would be brighter than (B).

Teacher: Showing card 1[“The current power is constant anywhere in a series circuit. Therefore the brightness of (A) and (B) are the same.”] What do you think about the idea on this card?

Student #9: [after 7 second delay] I think the card is right if the current is the same. But the resistance is different in this case.

Teacher: Your thought differs from the card. Which is correct?

Student #9: Mine is correct.

Teacher: Your thoughts now are different from the card. You may feel strange and conflicted by this. Would you mark the degree of conflict which is your feeling of strangeness or

confusion?

Student #9: [marked at 0]

In this example, the student did not recognize what should have been a conflict between his idea and the correct conception. The student rejected the explanation on card 1 since he was apparently convinced that his conception was correct.

Student #11

Teacher: [Asks the student to explain an answer on the pretest.]

Student #11: If bulbs are connected in series, voltage and current are the same. So two bulbs will have the same brightness.

Teacher: Showing card 2 [“Current moves from the positive pole to the negative pole. The energy of the current is consumed at (A), then (B) uses the rest of it. Thus (A) is brighter than (B)”]. What do you think about this card?

Student #11: Hum, it sounds good.

Teacher: Your thought differs from the card. Which is correct?

Student #11: Card 2 is correct.

Teacher: Why do you think your idea was wrong?

Student #11: My thinking is focused on the flow of current, not its consumption.

Teacher: Your thoughts now are different from the card. You may feel strange and conflicted by this. Would you mark the degree of conflict which is your feeling of strangeness or confusion?

Student #11: [marked at 3]

Teacher: Why?

Student #11: The card is better. May I try whether it really is?

Even though this student had the correct idea, he felt strong conflict by the logical argument presented on the card. This student accepted the idea on the card since the explanation was apparently plausible to him. However, he was not completely convinced of this and wanted to test this idea by conducting an experiment.

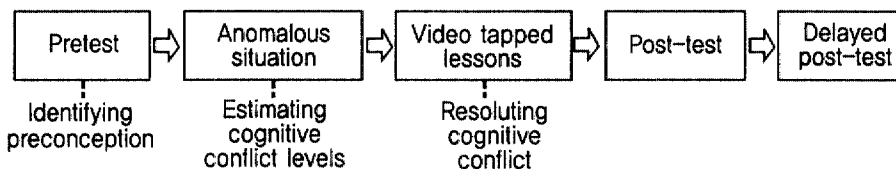

Fig. 7. Data collection procedure

## 5. Interview

A structured interview procedure was planned. Through the written tests and interview, we tested a student's prior conception, and the strength of conviction to that conception. Each interview consisted of a demonstration and 3-4 cards containing logical arguments. During interviews, the students was confronted with an anomalous situation using the demonstration or a logical argument. For example, a student who had chosen an incorrect answer was confronted with a logical argument situation in which the scientific conception was presented, or a demonstration situation that showed the correct result. Students who chose the correct answer and had the scientific reasoning for that choice were excluded from the research since their responses would confound the analysis. Conversely, each student who selected a correct answer was confronted with a logical argument that was intended to rationalize a misconception. The levels of the cognitive conflict were measured with the checklist in each structured interview by the researcher. Finally, the pattern of conceptual changes was determined by three written tests, an immediate post-test, and two delayed post-tests.

## 6. Intervention

Videotaped instruction was given to all students who participated in the research. This procedure was conducted immediately after an interview, and was composed of videotaped instruction that explained ten physics problems. In the lessons, the teacher introduced a problem by showing the experimental equipment. The teacher conducted the demonstration, showed the result, and then explained the result. After the video lesson, the teacher invited questions from students and answered them. Videotaped instruction required 50 minutes to complete.

## 7. post-test and delayed post-tests

The post-test was administered right after the intervention. The post-test instrument was identical to the pretest. A delayed post-test was also administered one month after the first post-test, again with the same test items.

## 8. The types of conceptual changes

The eight distinct types of conceptual changes were defined. By analyzing the students' choices and reasoning, these conceptions were classified into scientific and unscientific conceptions. Since three tests(pretest, post-test and delayed post-test) were conducted, students' conceptions could be placed in one of the eight types. Fig. 8 shows the relationship of the eight possible conceptions to one another, and to the tests administered.

The eight different types of conceptual change patterns could exist in two levels of knowledge

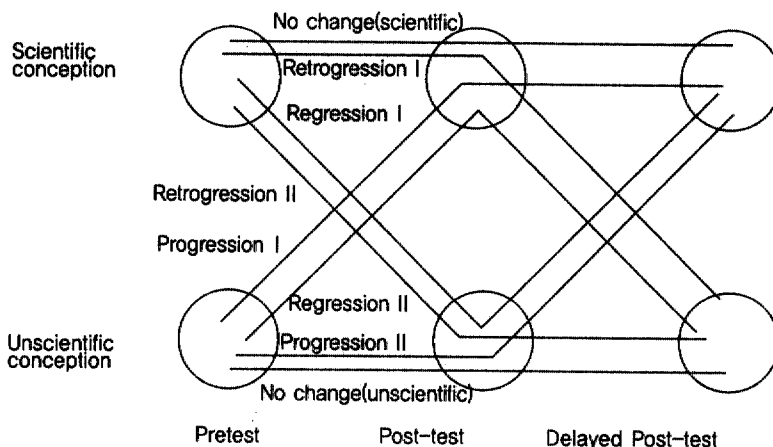

Fig. 8. The 8 types of conceptual changes

(scientific and unscientific), times three testing procedure. The eight types of conceptual change are no change (scientific), no change (unscientific), Retrogression I, Retrogression II, Regression I, Regression II, Progression I, and Progression II. There are two types of no change - retaining a scientific conception throughout the entire procedure, or retaining an unscientific conception. Retrogression I and II were assigned to cases where scientific conceptions changed to unscientific conceptions. In the specific case of type I Retrogression, students maintain a scientific conception to their post-test but end up with unscientific conceptions at a delayed post-test. By contrast for a type II Retrogression, a student would start with a scientific conception, but change to unscientific immediately.

Regression II and I were assigned to cases in which students change their original idea right after conflict but, return to the original thought at the time of the delayed post-test. In the case of type I Regression, students start from scientific conceptions, while in type II, they start from unscientific conceptions.

Progression I and II were assigned to students who started from unscientific conceptions, yet end up with scientific conceptions. For a type I Progression, students changed their idea immediately after recognizing the conflict with a more scientific conception at the delayed post-test. In type II Progression, a student kept their misconceptions on the post-test, but changed to scientific conceptions at the delayed post-test.

#### IV. Results and Discussion

In this study, patterns in student's conceptual change in terms of conflict inducing methods (i.e., demonstration and logical argument) were examined in mechanics and electricity. The levels of cognitive conflict (from 0 to 3), types of conflict responses (critical acceptance, critical

rejection, plain acceptance, plain rejection), and degrees of a students' confidence in their preconception (high, low), were used to indicate the type of change a student experienced.

A fourth variable, the type of conflict response, is very closely related to conflict level in that critical acceptance and critical rejection were both classified as high conflict, while plain acceptance and plain rejection were classified as low conflict. The last factor, the degrees of confidence a student expressed about his or her preconception, did not show significant differences in producing conceptual change. Therefore, the effect of the first three factors was the focus of this report.

To illustrate patterns of conceptual change, students' conceptions were divided into scientific and unscientific conceptions, and used lines to represent the trends of change from pretest to delayed post-test. The thickness of the line is proportional to the number of subjects who experienced this type of change (see Fig. 9).

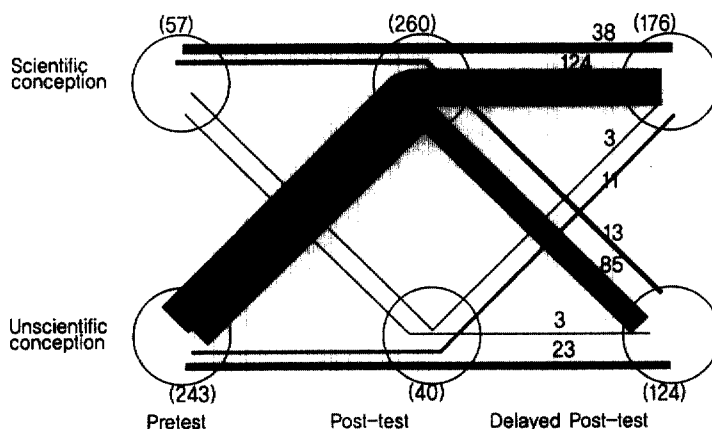

**Fig. 9.** The patterns of conceptual change by the total number of responses

The numbers in Fig. 9 represent the total number of responses from the 30 students in the study. The total number of responses is three hundred since the number of items was ten for thirty students. In the pretest, fifty-seven cases were identified as scientific conceptions, and 243 as unscientific conceptions. In the post-test, the distribution changed significantly to 260 scientific and 40 unscientific conceptions. However, this trend changed again in the delayed post-test when 176 scientific and 124 unscientific conceptions were identified.

In addition to the distribution of responses shown in Fig. 9, the number of students who changed from unscientific to scientific, from pretest to post-test, and from post-test to delayed post-test, are indicated. For example, 124 cases started with unscientific conceptions and changed into scientific conceptions, while only three cases changed from scientific to unscientific. Therefore, diverse patterns of conceptual changes as shown, in the diagram, could

be gained.

### 1. Conflict inducing methods

Fig. 10 shows the patterns of conceptual change by the method of inducing conflict. Type I Progression showed the most positive impact on conceptual change, while type 2 Regression showed the largest negative effect on conceptual change. These patterns are well distinguished by the method of inducing conflict. The type I Progression (unscientific - scientific - scientific) was significantly higher in demonstration than in logical argument. Of all the subjects in the study, 75 (53%) out of 141 cases in demonstration, and 49 (48%) out of 102 in logical argument, showed this type of conceptual change. In the case of type II Regression (unscientific - scientific - unscientific), the type of regression was significantly lower for demonstration than for logical argument. Finally, 44 (31%) out of 141 cases in demonstration, and 41 (40%) out of 102 cases in logical argument, showed this type of conceptual change.

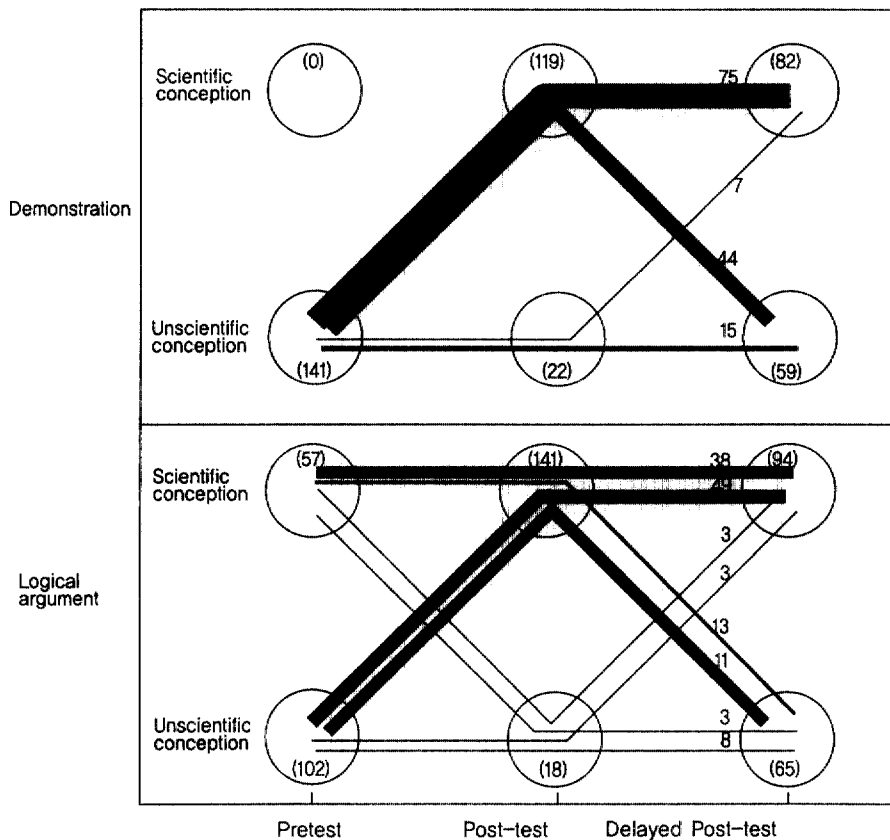

Fig. 10. The patterns of conceptual change by the method of inducing conflicts

The apparent effectiveness of the demonstration method over logical argument suggests that science learning would benefit from instruction that included this method of inducing cognitive conflict. Demonstration and logical argument methods were employed to induce students' cognitive conflicts in this research. The former included a visual presentation and discussion, while the latter included only a verbal presentation. It is expected that the demonstration method would be more effective than the logical argument method in the conceptual change. Fig. 10 and Fig. 11. show this difference clearly.

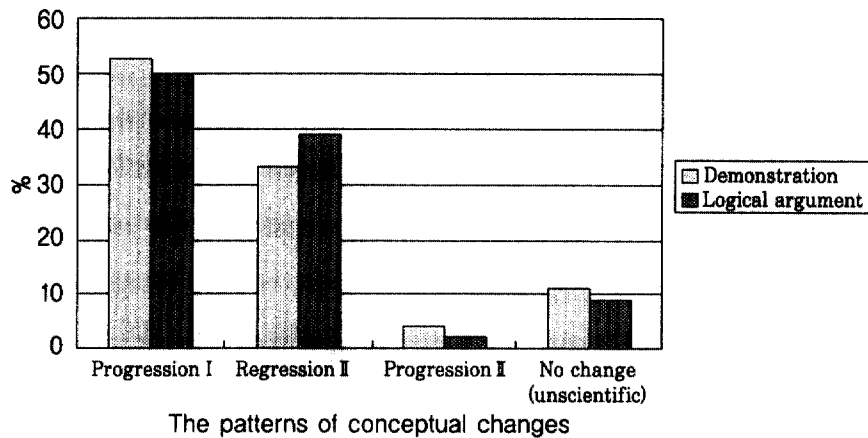

Fig. 11. Percentage of cases by conflict inducing

## 2. Content areas

Mechanics and electricity content were employed in this study because they are typically taught in high school physics classes. These areas are different in their characteristics - mechanics concepts are closely related to personal experiences, while electricity concepts are more abstract. This classification in a sense resembles the Vygotskian classification of everyday scientific concepts (Howe,1996).

Patterns of conceptual change by content areas are shown in the Fig. 12. Fig. 12 shows the difference in the conceptual change patterns. Type I Progression showed the largest positive effect on conceptual change, while Type II Regression showed the least effect on conceptual change. These patterns are further distinguished by the method of inducing conflict. Type I Progression (unscientific - scientific - scientific), for example, was significantly higher in mechanics than in electricity with 75 (63%) of 120 cases in mechanics, but only 49 (40%) of 123 in electricity showing this type of conceptual change.

In the case of type II Regression (unscientific - scientific - unscientific), this type of regression was significantly lower in the area of mechanics than in electricity. Only thirty (25%) of 120



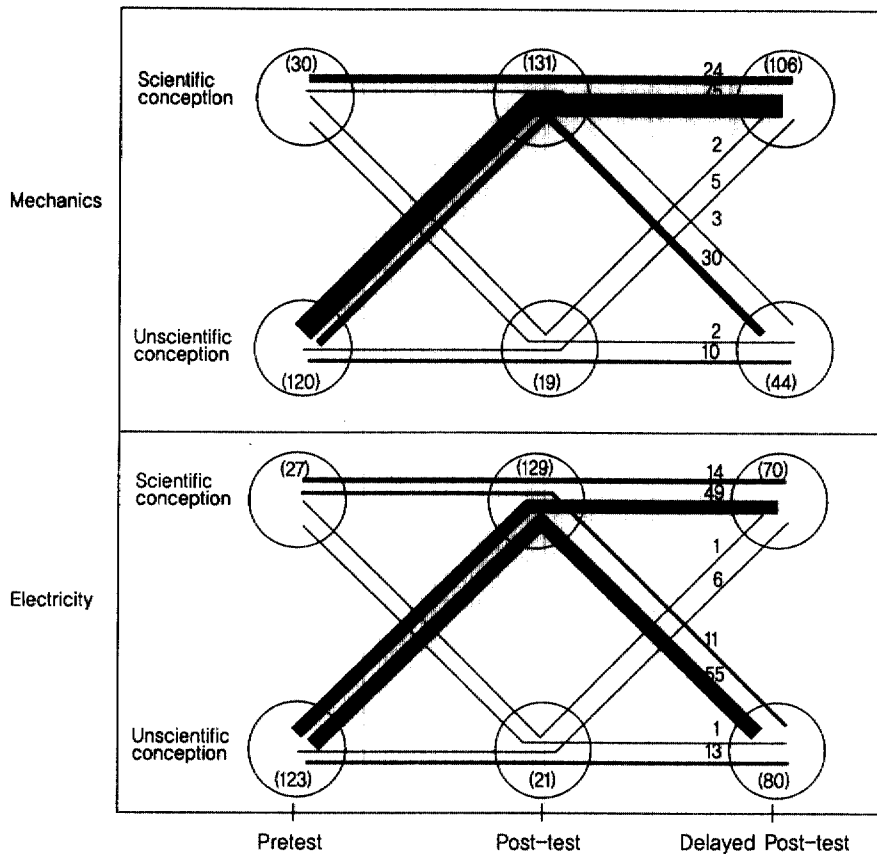

Fig. 12. The patterns of conceptual change by the content areas

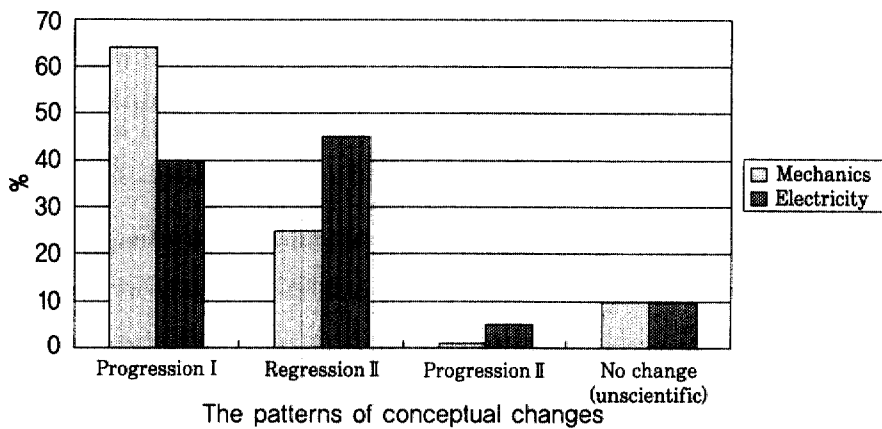

Fig. 13. Percentage of cases by content areas

cases in the mechanics unit changed, whereas fifty-five (45%) of 123 cases in the electricity unit showed conceptual change.

It can be inferred that mechanics concepts are more likely to be changed than electricity concepts. The advantage that mechanics concepts seem to have over electricity may be related to personal experience with phenomenon related to the concepts. In the case of mechanics, a concept such as inertia can be observed by watching a demonstration. By contrast, electricity concepts, such as electric current, cannot be observed directly. Instead, these concepts must be deduced from the intensity of light emitted by a bulb. As Vygotsky argued, a scientific concept is learned effectively by interaction with the scientific concepts and a student's everyday experience.

### **3. The levels of cognitive conflict**

For the purposes of this study, levels of cognitive conflict were divided into low, medium, and high, based on scores given by interviewers. The low conflict group was assigned a score of 0 and 1, the medium conflict group a score of 2, and the high conflict group a score of 3. Fig. 14 shows the pattern of conceptual change by level of cognitive conflict. Type I Progression showed the largest positive effect on conceptual change, while type II Regression showed the least effect on conceptual change.

Levels of conflict were also useful in distinguishing patterns of conceptual change. The type I Progression (unscientific - scientific - scientific) increased significantly from low conflict students to high conflict students. In the high conflict group, 59 (56%) of 105 cases showed conceptual change, a change that was retained, while 49 (53%) of 92 cases in the medium level conflict group, and only 16 (35%) of 46 cases in the low level conflict group, showed this type of conceptual change. In the case of type II Regression (unscientific - scientific - unscientific), this type of regression was slightly decreased from the low conflict to high conflict level. 33 (31%) of 105 cases in the high conflict group, 33 (36%) of 92 cases in medium level, and 19 (41%) of 46 cases in low conflict group, showed type II Regression.

The results of this study showed that the level of cognitive conflict was a very effective measure of long-term conceptual change. These result are in agreement with other research (Niaz, 1995; Stavy & Berkovitz, 1980; Stofflett, 1994; Thorley & Treagust, 1987). Thorley and Treagust (1987) reported that about half of the students who experienced a high cognitive conflict changed their preconceptions where as only one out of six of those who experienced a low cognitive conflict changed their preconceptions. Posner et al (1982) pointed out that dissatisfaction with one's existing conception is a precondition for conceptual change to occur. Inducing conflict through instruction that included demonstrations or logical arguments can help generate the type of cognitive conflict that leads to conceptual change.

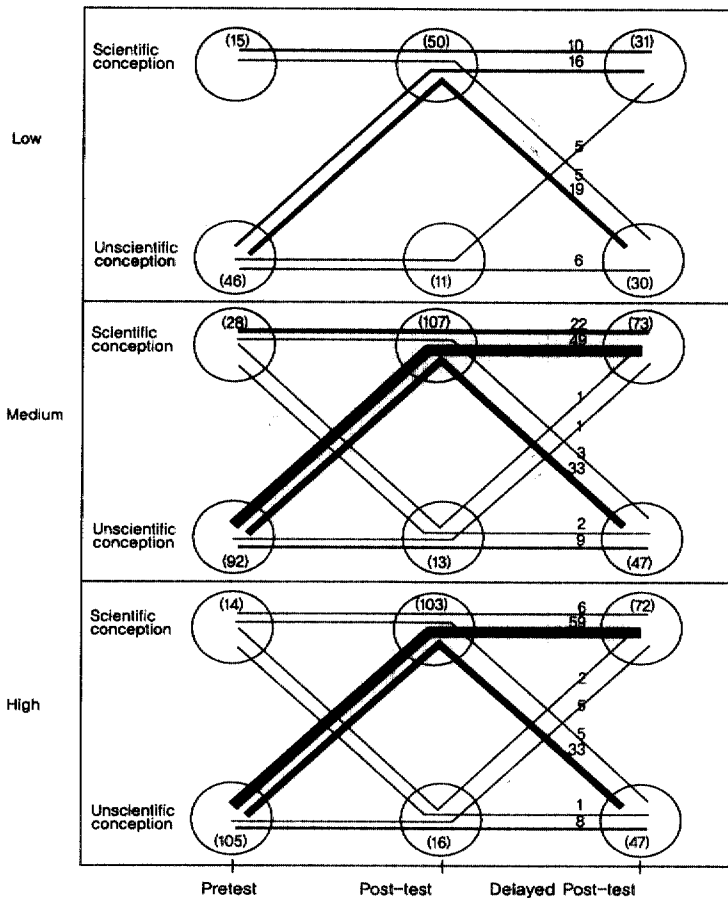

Fig. 14. The patterns of conceptual change by the levels of cognitive conflict

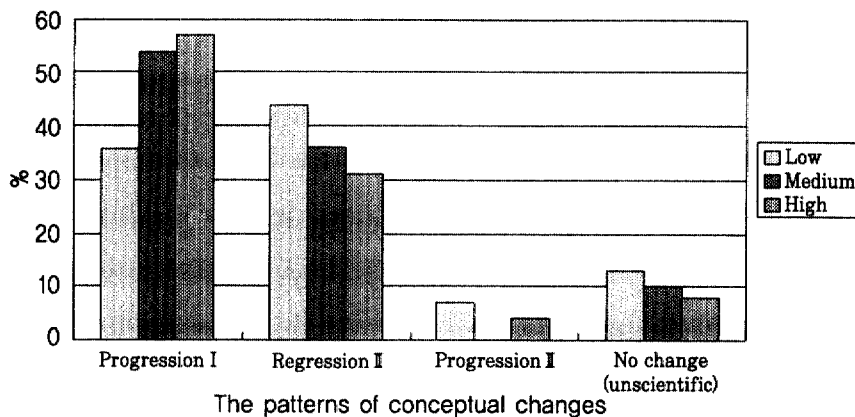

Fig. 15. Percentage of cases by conflict levels

## V. Summary and Conclusions

In this article, the issue of the effect of cognitive conflict on conceptual change was clarified. There is fairly general agreement that cognitive conflict is necessary for a conceptual change to occur. However, there has been lack of empirical evidence supporting the effectiveness of cognitive conflict on producing conceptual change. Furthermore, there has been little or no effort to describe the various types of conflicts that might produce conceptual change for students. In this study, a scheme was developed to estimate levels of cognitive conflict, and then examined the effect of high, medium and low conflict levels on conceptual changes. Two different conflict-arousing strategies - demonstration and logical argument were used. The two strategies were applied to typical physical science topics, mechanics and electricity.

To validate the long term effects of these strategies, pretest, post-test and delayed post-test were conducted. The results of our study indicated that three variables - conflict-arousing strategies, content areas, and the perceived level of conflict - contributed to change in a conception. The method most effective for inducing this conflict was demonstration, followed by logical argument. Students changed their concepts more easily and frequently in the area of mechanics than in electricity. The most significant effect on conceptual change was found in the last variable, the level of cognitive conflict experienced by students. Here, students who expressed higher levels of conflict showed higher rates of conceptual change, while those who experienced low levels conflict showed very little change.

Unlike former studies on the effects of cognitive conflict, the levels of cognitive conflict quantitatively was estimated, and the effects of conflict on conceptual change were also examined. It could be concluded that a slight change of conflict level affected the patterns of conceptual change, and that designing instruction to induce cognitive conflict is a useful strategy to use in conceptual change instruction.

## References

- Dreyfus, A., Jungwirth, E. & Eliovitch, R. (1990). Applying the cognitive conflict strategy for conceptual change-some implications, difficulties, and problems. *Science Education*, 74, 555-569.
- Druyan, S. (1997). Effects of the kinesthetic conflict on promoting scientific reasoning. *Journal of Research in Science Teaching*, 34, 1083-1099.
- Flavell, J. H. (1977). *Cognitive development*. Prentice-Hall: Englewood Cliffs, N. J.
- Hashweh, M. Z. (1986). Toward an explanation of conceptual change. *European Journal of Science Education*, 8, 229-249.
- Hewson, P. (1981). A conceptual approach to learning science, *European Journal of Science Education*, 3, 383-396.
- Hewson, P. W. & Hewson, M. G. A. (1984). The role of conceptual conflict in conceptual

- change and the design of science instruction. *Instructional Science*, 13, 1-13.
- Howe, A. C. (1996). Development of science concepts within a Vygotskian framework. *Science Education*, 80, 33-51.
- Kuhn, T. S. (1970). *The structure of scientific revolution*. University of Chicago Press: Chicago.
- Kwon, J. (1992). A comparative discussion on the instructional procedure and strategies on learning scientific concepts. *Journal of the Korean Association for Research in Science Education*, 12, 19-29.
- Kwon, J. (1989). A cognitive model of conceptual change in science learning. *Physics Education*, 7, 1-9.
- Lakatos, I., & Musgrave, A. (1974). *Criticism and the growth of knowledge*. Cambridge University Press.
- Lee, Y., & Kwon, J. (1992). The index of the stability of misconceptions, *Journal of the Korean Association for Research in Science Education*, 13, 310-316.
- Niaz, M. (1995). Cognitive conflict as a teaching strategy in solving chemistry problems: A dialectic-constructivist perspective. *Journal of Research in Science Teaching*, 32, 959-970.
- Posner, G., Strike, K., Hewson, P. & Gertzog, W. (1982). Accommodation of a scientific conception: Toward a theory of a conceptual change. *Science Education*, 66, 211-227.
- Stavy, R. & Berkovitz, B. (1980). Cognitive conflict as a basis for teaching quantitative aspects of the concept of temperature. *Science Education*, 64, 679-692.
- Stofflett, R. T. (1994). The accommodation of science pedagogical knowledge : The application of conceptual change constructs to teacher education. *Journal of Research in Science Teaching*, 31, 787-810.
- Strike, K., & Posner, G. (1985). Conceptual change view of learning and understanding. In L. T. West and A. L. Pines (Eds.), *Cognitive structure and conceptual change*. London Academic Press, 211-230.
- Thijs, G. D. (1987). Conceptions of force and movement, intuitive ideas of pupils in Zymbabwe in comparison with findings from other countries. *Proceedings of the second international seminar: Misconceptions and educatioal strategies in science and mathematics, Volume III*, Cornell University, Ithaca, NY, USA, 501-513.
- Thorley, N. R. & Treagust, D. F. (1987). Conflict within dyadic interactions as a stimulant for conceptual change in physics. *International Journal of Science Education*, 9, 203-216.