

# Numerical Simulation of Shock Wave Propagation using the Finite Difference Lattice Boltzmann Method

**Ho-Keun Kang\***

*School of Transport Vehicle Engineering · Institute of Marine Industry, Gyeongsang National University,  
445 Inpyeong-dong, Tongyeong, Gyeongnam 650-160, Korea*

**Michihisa Tsutahara**

*Graduate School of Science and Technology, Kobe University  
1-1 Rokkodai, Nada, Kobe 657-8051, Japan*

**Ki-Deok Ro**

*School of Transport Vehicle Engineering · Institute of Marine Industry, Gyeongsang National University,  
445 Inpyeong-dong, Tongyeong, Gyeongnam 650-160, Korea*

**Young-Ho Lee**

*Division of Mechanical & Information Engineering, Korea Maritime University,  
1 Dongsam-dong, Youngdo-ku, Pusan 606-791, Korea*

The shock wave process represents an abrupt change in fluid properties, in which finite variations in pressure, temperature, and density occur over the shock thickness which is comparable to the mean free path of the gas molecules involved. This shock wave fluid phenomenon is simulated by using the finite difference lattice Boltzmann method (FDLBM). In this paper, a new model is proposed using the lattice BGK compressible fluid model in FDLBM for the purpose of speeding up the calculation as well as stabilizing the numerical scheme. The numerical results of the proposed model show good agreement with the theoretical predictions.

**Key Words :** Finite Difference Lattice Boltzmann Method, BGK Model, Compressible Fluid, Shock Wave, Wave Reflection

## Nomenclature

$a_s$  : Speed of sound  
 $c$  : Particle velocity  
 $e$  : Internal energy  
 $f$  : Particle distribution function  
 $f^{(0)}$  : Equilibrium distribution function  
 $i$  : Direction of particle velocity  
 $M_s$  : Shock wave Mach number  
 $P$  : Pressure  
 $Re$  : Reynolds number  
 $t$  : Time  
 $u$  : Fluid velocity

## Greek symbols

$\alpha$  : Cartesian coordinates  
 $\gamma$  : Coefficient of specific heats  
 $k^*$  : Thermal conductivity  
 $\lambda$  : Second viscosity  
 $\nu$  : Kinematic viscosity  
 $\rho$  : Density  
 $\sigma$  : Number of speeds of the particles  
 $\tau$  : Time increment  
 $\phi$  : Relaxation time

## 1. Introduction

In recent years, the lattice gas automata (LGA) (MaNamara et al., 1988; Qian et al., 1995; Rothman et al., 1997) or the lattice Boltzmann method (LBM) (Alexander et al., 1993; Chen et al., 1994; Huang et al., 1997) has received considerable attention as an alternative numerical

\* Corresponding Author,

**E-mail :** kang88@gaechuk.gsnu.ac.kr

**TEL :** +82-55-640-3064; **FAX :** +82-55-640-3128

School of Transport Vehicle Engineering·Institute of Marine Industry, Gyeongsang National University, 445 Inpyeong-dong, Tongyeong, Gyeongnam 650-160, Korea. (Manuscript Received December 14, 2001; Revised June 25, 2002)

scheme for simulating complex transport phenomena. The finite difference lattice Boltzmann method (FDLBM) (Cao et al., 1997) is one of the computational fluid mechanics models which has been developed from LBM. In LBM, fluid is treated as discrete groups of many particles repeating collision and translation (movement), and the macroscopic fluid motion is expressed by calculating these two modes of particle motions.

In developing the LBM and FDLBM, many investigators have examined the fluid flows such as thermal creep flow, density-stratified flows and unsteady shock wave. The thermo-hydrodynamic model has been also developed and verified (Tsutahara et al., 2002).

The LBM has, however, many shortcomings such as numerical instability in heat flow problems or high Reynolds number flows. Besides it is generally known that this method requires enormous calculation time when it is applied to the flows of high Reynolds number and boundary fitted coordinate system is examined.

In this paper, a new model is proposed using the lattice BGK compressible fluid model in FDLBM for the purpose of speeding up the calculation as well as stabilizing the numerical scheme.

## 2. Foundations of FDLBM

In the lattice BGK model in FDLBM which has been used until now, the collision term in the fundamental equation has been expressed as

$$\frac{\partial f_i}{\partial t} + c_i \nabla f_i = -\frac{1}{\phi} (f_i - f_i^{(0)}) \quad (1)$$

Equation (1) has the Taylor expansion of lattice Boltzmann equation, and has a form equal to the approximate Boltzmann equation which adopts the first term.

The dynamics of the fluid can be described by the distribution function obeying the lattice BGK equation (1) and the macroscopic variables are given by the equilibrium distribution function. Here, the fundamental physical variables are the density  $\rho$ , the momentum  $\rho u_\alpha$  and the internal energy  $e$ . These variables are defined as

$$\rho = \sum_{\sigma,i} f_{\sigma i} = \sum_{\sigma,i} f_{\sigma i}^{(0)} \quad (2)$$

$$\rho u_\alpha = \sum_{\sigma,i} f_{\sigma i} c_{\sigma i \alpha} = \sum_{\sigma,i} f_{\sigma i}^{(0)} c_{\sigma i \alpha} \quad (3)$$

$$\begin{aligned} \rho e &= \sum_{\sigma,i} \frac{1}{2} f_{\sigma i} c_{\sigma i}^2 - \frac{1}{2} \rho u^2 \\ &= \sum_{\sigma,i} \frac{1}{2} f_{\sigma i}^{(0)} c_{\sigma i}^2 - \frac{1}{2} \rho u^2 \end{aligned} \quad (4)$$

Then, to determine the distribution function of Eq. (1), we start with the Maxwellian equilibrium function for the kinetic theory

$$f^{eq} = \frac{\rho}{(2\pi RT)^{3/2}} \exp \left[ -\frac{(c_\alpha - u_\alpha)^2}{2RT} \right] \quad (5)$$

$(\alpha = x, y, z)$

where  $R$  is the gas constant,  $T$  is the absolute temperature,  $u_\alpha$  and  $c_\alpha$  are the fluid velocity and the molecular velocity, respectively, and subscript  $\alpha$  represents the Cartesian coordinates.

When the Mach number of the flow is small, Eq. (5) is Taylor expanded about  $u_\alpha = 0$  up to the third order, then we obtain

$$\begin{aligned} f^{eq} &= A e^{Bc^2} \rho \left[ 1 - 2B c_\alpha u_\alpha + 2B^2 c_\alpha c_\beta u_\alpha u_\beta + B u^2 \right. \\ &\quad \left. - 2B^2 c_\alpha u_\alpha u^2 - \frac{4}{3} B^3 c_\alpha c_\beta c_\gamma u_\alpha u_\beta u_\gamma \right] \end{aligned} \quad (6)$$

where

$$A = \frac{1}{(2\pi RT)^{3/2}}, \text{ and} \quad (7)$$

$$B = -\frac{1}{2RT} \quad (8)$$

but hereafter the particle velocities are discretized and these constants are determined from the constraints so that the distribution function in Eq. (1) derives the Navier-Stokes equations.

$$\begin{aligned} f_i^{eq} &= A_i e^{Bc_i^2} \rho \left[ 1 - 2B c_{\sigma i \alpha} u_\alpha + 2B^2 c_{\sigma i \alpha} c_{\sigma i \beta} u_\alpha u_\beta + B u^2 \right. \\ &\quad \left. - 2B^2 c_{\sigma i \alpha} u_\alpha u^2 - \frac{4}{3} B^3 c_{\sigma i \alpha} c_{\sigma i \beta} c_{\sigma i \gamma} u_\alpha u_\beta u_\gamma \right] \end{aligned} \quad (9)$$

The coefficient  $A_i e^{Bc_i^2} = F_{\sigma i}$  varies particle to particle, then Eq. (9) can be written as

$$\begin{aligned} f_{\sigma i}^{(0)} &= F_{\sigma i} \rho \left[ 1 - 2B c_{\sigma i \alpha} u_\alpha + 2B^2 c_{\sigma i \alpha} c_{\sigma i \beta} u_\alpha u_\beta + B u^2 \right. \\ &\quad \left. - 2B^2 c_{\sigma i \alpha} u_\alpha u^2 - \frac{4}{3} B^3 c_{\sigma i \alpha} c_{\sigma i \beta} c_{\sigma i \gamma} u_\alpha u_\beta u_\gamma \right] \end{aligned} \quad (10)$$

The moving particles are allowed to move with five kinds of speed,  $c$ ,  $2c$ ,  $3c$ ,  $\sqrt{2}c$  and  $2\sqrt{2}c$ , and the particles are 21 kinds, as shown in Fig. 1. Here, the velocity of particles is determined by

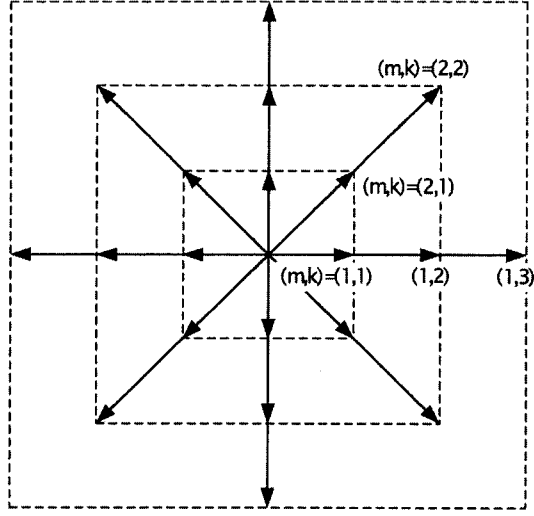

**Fig. 1** A compressible lattice Boltzmann model (2D21V)

$$c_{mki} = k\sqrt{m}c \left[ \cos\left(\frac{\pi(i-1)}{2} + \frac{\pi(m-1)}{4}\right), \right. \\ \left. \sin\left(\frac{\pi(i-1)}{2} + \frac{\pi(m-1)}{4}\right) \right] \quad (11) \\ (i=1, \dots, 4, m=1, 2, k=1, 2, \dots)$$

where  $\sigma$  shows  $m$  and  $k$  in Eq. (11). The index  $m=1$  indicates the particle which moves in the orthogonal direction and  $m=2$  indicates the particle which moves in the diagonal direction. The  $k$  represents the speed of particle which moves in the nearest neighboring lattice. The function  $F_0$ ,  $F_{11}$ ,  $F_{12}$ ,  $F_{13}$ ,  $F_{21}$  and  $F_{22}$ , respectively, are determined by

$$F_0 = 1 + \frac{5}{4Bc^2} \left( \frac{17}{96B^2c^4} + \frac{35}{48Bc^2} + \frac{49}{45} \right) \quad (12)$$

$$F_{11} = -\frac{1}{8Bc^2} \left( \frac{13}{16B^2c^4} + \frac{71}{24Bc^2} + 3 \right) \quad (13)$$

$$F_{12} = \frac{1}{16Bc^2} \left( \frac{5}{16B^2c^4} + \frac{25}{24Bc^2} + \frac{3}{5} \right) \quad (14)$$

$$F_{13} = -\frac{1}{24Bc^2} \left( \frac{1}{16B^2c^4} + \frac{1}{8Bc^2} + \frac{1}{15} \right) \quad (15)$$

$$F_{21} = \frac{1}{4B^3c^6} \left( \frac{Bc^2}{3} + \frac{1}{8} \right) \quad (16)$$

$$F_{22} = -\frac{1}{153B^3c^6} (2Bc^2 + 3) \quad (17)$$

$$\text{and } B = -\frac{1}{2e} \quad (18)$$

By using Chapman-Enskog expansion for Eq. (1), and taking the moment of  $c_i$ , the Navier-Stokes equations are obtained as

$$\frac{\partial \rho}{\partial t} + \frac{\partial}{\partial r_{1\alpha}} (\rho u_\alpha) = 0 \quad (19)$$

$$\frac{\partial}{\partial t} (\rho u_\alpha) + \frac{\partial}{\partial r_{1\beta}} (\rho u_\alpha u_\beta) = -\frac{\partial P}{\partial r_{1\alpha}} \\ + \frac{\partial}{\partial r_{1\beta}} \nu \left( \frac{\partial u_\beta}{\partial r_{1\alpha}} + \frac{\partial u_\alpha}{\partial r_{1\beta}} \right) + \frac{\partial}{\partial r_{1\alpha}} \left( \lambda \frac{\partial u_\gamma}{\partial r_{1\gamma}} \right) \quad (20)$$

$$\frac{\partial}{\partial t} \left( \rho e + \frac{1}{2} \rho u^2 \right) + \frac{\partial}{\partial r_{1\alpha}} \left( \rho e + P + \frac{1}{2} \rho u^2 \right) u_\alpha \\ = \frac{\partial}{\partial r_{1\alpha}} \left( k^* \frac{\partial e}{\partial r_{1\alpha}} \right) + \frac{\partial}{\partial r_{1\alpha}} \left\{ \nu u_\beta \left( \frac{\partial u_\beta}{\partial r_{1\alpha}} + \frac{\partial u_\alpha}{\partial r_{1\beta}} \right) \right\} \\ + \frac{\partial}{\partial r_{1\alpha}} \left( \lambda \frac{\partial u_\beta}{\partial r_{1\beta}} u_\alpha \right) \quad (21)$$

The pressure, the kinematic viscosity, the second viscosity and the conductivity of the internal energy are given, respectively, by

$$P = \frac{2}{D} \rho e \quad (22)$$

$$\nu = \frac{2}{D} \rho e \tau \left( \phi - \frac{1}{2} \right) \quad (23)$$

$$\lambda = -\frac{4}{D^2} \rho e \tau \left( \phi - \frac{1}{2} \right) = -\nu \quad (24)$$

$$k^* = \frac{2(D+2)}{D^2} \rho e \tau \left( \phi - \frac{1}{2} \right) \quad (25)$$

where  $\tau$  is the time increment,  $D$  is the characteristic dimension and the value of  $D$  is 2 for two-dimensional cases.

In Eq. (1) and Eq. (23), the relation between the coefficient of kinematic viscosity  $\nu$  deduced and the single relaxation coefficient  $\phi$  becomes  $\phi \sim \nu$  when compared to the Navier-Stokes equation.

Here, if the time development is expressed by the Euler method, the finite difference form of Eq. (1) is written as

$$f_i^{n+1} = f_i^n - \Delta t \cdot \left\{ c_{i\alpha} \frac{\partial f_i^n}{\partial r_\alpha} + \frac{1}{\phi} (f_i^n - f_i^{(0)}) \right\} \quad (26)$$

In Eq. (26), the coefficient which depends on the collision term is  $\Delta t/\phi$ , when we consider the collision term of the righthand side of the equation.

The condition of  $\Delta t/\phi < 2.0$  is established on the coefficient in FDLBM as well as the stability

condition of the collision term in LBM is  $1/\phi < 2.0$ . In FDLBM,  $\phi$  is very small value in high Reynolds number flows from the relation between the coefficient of kinematic viscosity and the single relaxation coefficient,  $\phi \sim \nu$ . Also, from the stability condition of the collision term,  $\Delta t$  must be taken small value to satisfy the condition of the collision term. Therefore, the enormous calculation time is required to ensure good numerical solutions.

### 3. Formulation of a New Model

Here, we propose a new model in order to solve the problem as stated above. To begin with, we consider FDLBM as one of the schemes for deducing the Navier-Stokes equation. We also consider that the relation between the coefficient of the kinematic viscosity  $\nu$  and the single relaxation coefficient  $\phi$  is derived by disregarding the physical meaning of the fundamental equation, but adding some appropriate terms to the fundamental equation.

In deducing the Navier-Stokes equation, the Taylor expansion, as one of the concrete methods, is employed in the derivation process of the viscosity term in LBM. Then we deduce the viscosity terms by adopting the secondary term. From this fact, it is well known that the difference between LBM and the fundamental equation, in which the viscosity coefficient is derived from the conventional FDLBM, is the existence of the term of the secondary order, which should be introduced into the equation of the conventional FDLBM.

Here, the term of the secondary derivative in the differential equation corresponds to the diffusion. Also, in the point of the viscosity, it is regarded that the term of the secondary order is effective for the operation of the viscosity coefficient. Therefore, we can propose that the relation between the viscosity coefficient and the single relaxation coefficient can be altered by adding the term of the secondary order. Then, we are able to carry out the speed up, which is difficult in the conventional FDLBM model.

As a way of adding secondary order, the numerical calculation should be carried out by

introducing the term  $-ac_\alpha \frac{\partial}{\partial r_\alpha} \frac{f_i - f_i^{(0)}}{\phi}$ . In another words, we transform the fundamental Eq. (1) as follows :

$$\begin{aligned} \frac{\partial f_i}{\partial t} + c_{i\alpha} \frac{\partial f_i}{\partial r_\alpha} - ac_{i\alpha} \frac{\partial}{\partial r_\alpha} \frac{f_i - f_i^{(0)}}{\phi} \\ = -\frac{1}{\phi} (f_i - f_i^{(0)}) \end{aligned} \quad (27)$$

Here, the added term is similar to  $-ac_\alpha \frac{\partial}{\partial r_\alpha} \frac{f_i^{(1)}}{\phi}$ , which can be obtained when the governing equation of the flow is deduced by the Chapman-Enskog development, and  $a$  represents an any coefficient.

Substituting Eqs. (2), (3) and (4) into Eq. (27), and taking terms up to the first order  $\epsilon$ , we can obtain

$$\frac{\partial f_i^{(0)}}{\partial t_1} + c_{i\alpha} \frac{\partial f_i^{(0)}}{\partial r_\alpha} = -\frac{1}{\phi} f_i^{(1)} \quad (28)$$

Here, the added term is transformed with

$$a\tau c_\alpha c_\beta \frac{\partial^2}{\partial r_\alpha \partial r_\beta} f_i^{(0)} + a\tau c_\alpha \frac{\partial^2}{\partial t_1 \partial r_\alpha} f_i^{(0)} \quad (29)$$

When the Taylor expansion of LBM is done up to the second order, the equation is written as

$$\begin{aligned} \frac{\partial f_{\alpha i}}{\partial t} + c_{\alpha i} \frac{\partial f_{\alpha i}}{\partial r_\alpha} + \frac{1}{2} \tau c_{\alpha i \alpha} c_{\sigma \beta} \frac{\partial^2 f_{\alpha i}}{\partial r_\alpha \partial r_\beta} + \tau c_{\sigma i \alpha} \frac{\partial^2 f_{\alpha i}}{\partial t \partial r_\alpha} + \frac{1}{2} \tau \frac{\partial^2 f_{\alpha i}}{\partial t^2} \\ = -\frac{1}{\tau \phi} (f_{\alpha i} - f_{\alpha i}^{(0)}) \end{aligned} \quad (30)$$

This expression is equal to the equation after the term of the second derivative in time is removed and when it compared with the equation of LBM with the parameters being set as  $\tau=1.0$  and  $a=0.5$ . By conducting such conversion, it is possible to modify the relationship between the coefficient of the kinematic viscosity and the single relaxation coefficient ( $\phi \sim \nu$ ) to  $\phi - a \sim \nu$  in FDLBM.

By these procedures, the single relaxation coefficient  $\phi$  becomes  $\phi \rightarrow a$  in the flow of high Reynolds number, and the proposed new model of FDLBM makes it possible to calculate with the fixed value of  $\phi$  which is taken in high Reynolds number flows. Also, it becomes possible that the calculation of  $\Delta t$  can easily or stably simulate up to large value, while  $\Delta t/\phi=2.0$  is

an upper limit for the collision term in the conventional FDLBM model.

#### 4. Calculation Speed-up

In this section, we discuss on the calculation speed-up which becomes possible by modifying the relationship between the viscosity coefficient  $\nu$  and the single relaxation coefficient  $\phi$  by adding the term in Eq. (27).

First, when the high Reynolds number is considered, it is the major difference between the proposed FDLBM model and the conventional FDLBM model that as  $Re \rightarrow \infty$ , the relaxation time  $\phi \rightarrow 0.0$  in the conventional FDLBM, whereas  $\phi \rightarrow a$  in the proposed model. From this fact, in order to satisfy the condition  $\Delta t/\phi < 2.0$  which is a condition of the coefficient depending on the collision term, the calculation stability could not be achieved if  $\Delta t \rightarrow 0$  is not given in the conventional FDLBM. In the proposed FDLBM, however, the time becomes  $\Delta t \rightarrow 2.0 \cdot a$ . Therefore, we can easily promote the calculation stability in  $\Delta t$  to some extent in size.

#### 5. Numerical Results

To examine the characteristics of the shock wave and the reflection wave as well as the validity of the newly proposed FDLBM, we use both the conventional model and the proposed model. The shock propagation process represents an abrupt change in fluid properties. Shocks also occur in the flow of a compressible medium through ducts or nozzles and thus may have a decisive effect on such flows. An understanding of the shock process and its ramifications is essential to the study of compressible flows.

First, we examine a shock tube flow. A conceptual scheme of shock tube is shown in Fig. 2. The pressure distribution is also illustrated. The shock tube is a device in which normal shock waves are generated by the rupture of a diaphragm initially separating a high-pressure gas from the low-pressure gas. After the rupture of the diaphragm, the system eventually approaches to a thermodynamic equilibrium state, with the

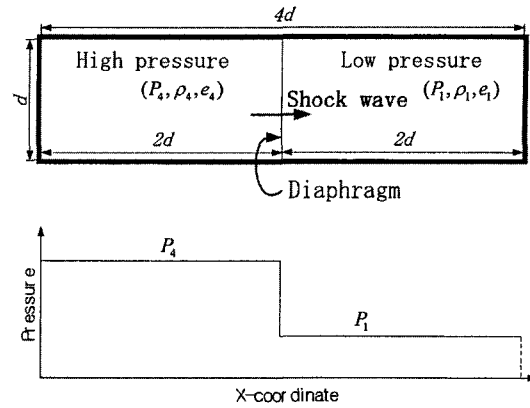

Fig. 2 Simulated flow field in a shock tube (2D21V)

final state of the closed-end tube determined from the first law of thermodynamics. With no external heat transfer, the total internal energy of the gas at the final state is equal to the sum of the internal energy of the gases initially present on the both sides across the diaphragm.

However, of primary interest is not the final equilibrium state of the gas, but the transient shock phenomena occurring immediately after the rupture of the diaphragm. Upon rupturing the diaphragm, a normal shock wave moves into the low-pressure side, with a series of expansion waves propagating into the high-pressure side.

The speed of shock  $c_s$  is defined as

$$c_s = M_s a_{s1} \quad (31)$$

where  $M_s$  is the shock Mach number. The term  $a_s$  will be explained later in this section. The fundamental equation of shock tube can be written as

$$\frac{P_4}{P_1} = \frac{P_2}{P_1} \left[ 1 - \frac{(\gamma_4 - 1) (a_{s1}/a_{s4}) (P_2/P_1)}{\sqrt{2\gamma_1} \sqrt{2\gamma_1 + (\gamma_1 + 1) (P_2/P_1 - 1)}} \right]^{-2\gamma_4/(\gamma_4 - 1)} \quad (32)$$

where  $a_{s1}$ ,  $a_{s4}$  are the front sound velocity and the rear sound velocity of shock wave, respectively.

As the initial parameters, if we set the initial pressure ratio of  $P_4/P_1 = 7.0$ , the time  $\Delta t = 0.01$  and the temperature in both partitions  $e_1 = e_4 = 0.85$ , the shock Mach number becomes  $M_s = 1.645$ . The calculated pressure distributions after the diaphragm rupture are shown in Fig. 3. It is

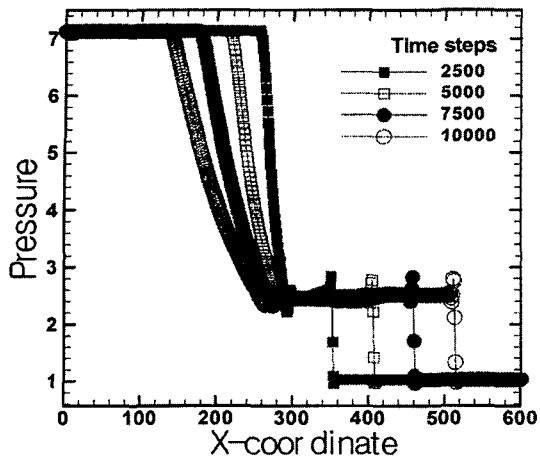
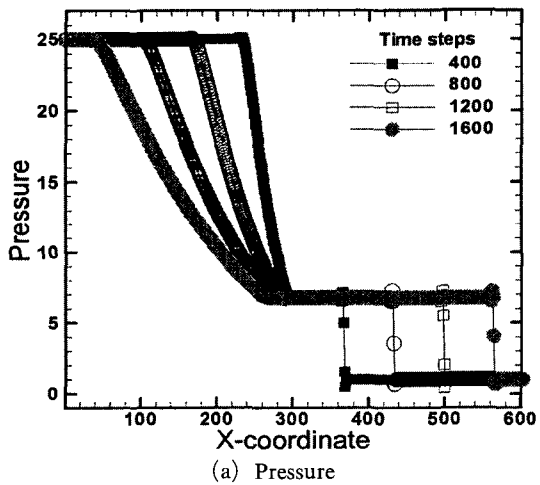

Fig. 3 Flow field in a shock tube simulated with 2D21V model by the conventional FDLBM

noted that the pressure ratio over 7.0 is not completed by using the conventional FDLBM.

Next, with the proposed model, we put the initial pressure ratio of  $P_4/P_1=25.0$ , the time  $\Delta t=0.1$  as the initial conditions, and the shock Mach number is  $M_s=2.215$ . The simulated flow fields are shown in Fig. 4. Here, it is noted that the calculation with the proposed model is stably completed even for the pressure ratios three times as high as those in the cases of the conventional model calculation. Also, in the cases shown in Fig. 3 and Fig. 4 the proposed model is able to speed up the calculation more than ten times faster than the conventional model.

In Fig. 4(a), the shock waves are resolved by 5



(a) Pressure

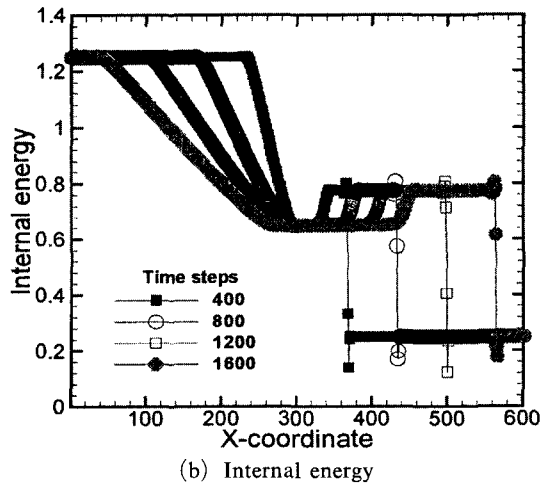

(b) Internal energy

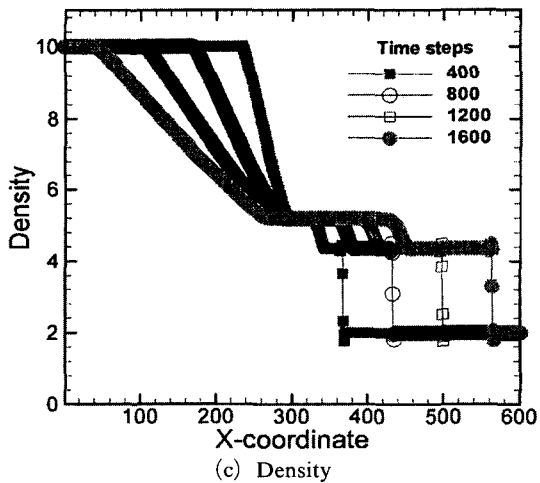

(c) Density

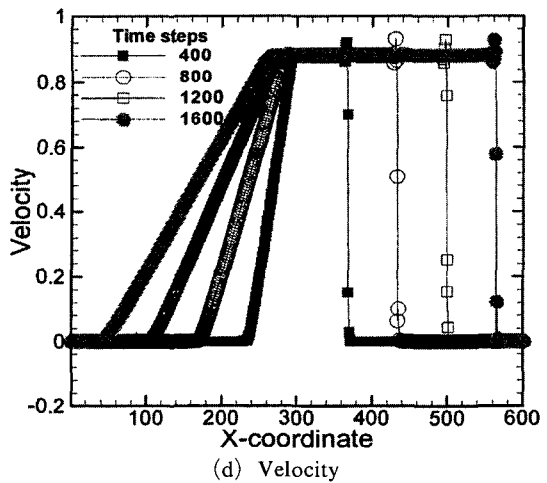

(d) Velocity

Fig. 4 Flow field in a shock tube simulated with 2D21V model by the proposed FDLBM

lattices, and there is not observed any oscillatory trend, which is often observed in the behind of the wave front. Figure 5 shows the relation between

the initial pressure ratio and the pressure ratio of the front and the behind of shock wave. In this case, we estimate the error is within 0.02% and

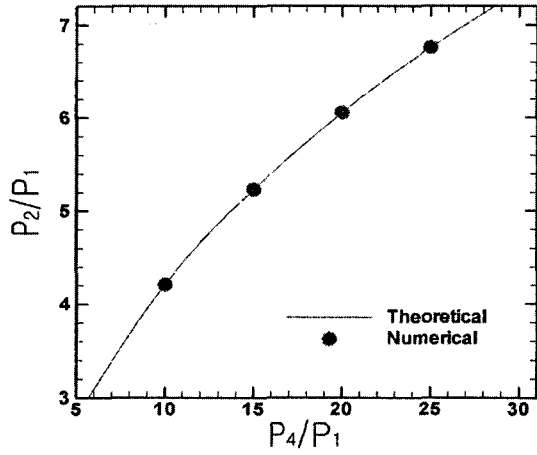

Fig. 5 Results of the pressures at the front and rear of shock wave (by the proposed FDLBM)

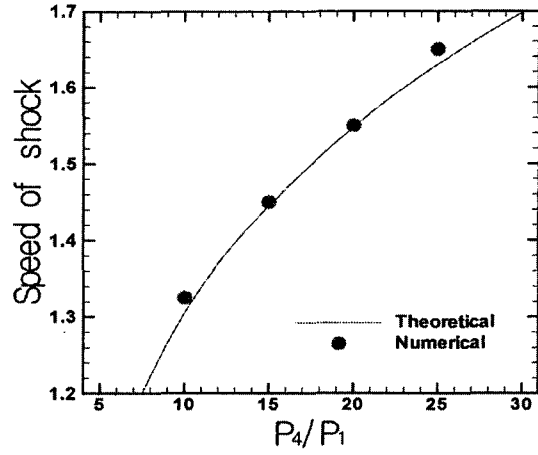
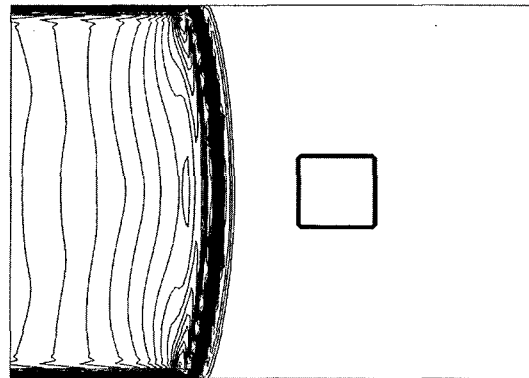
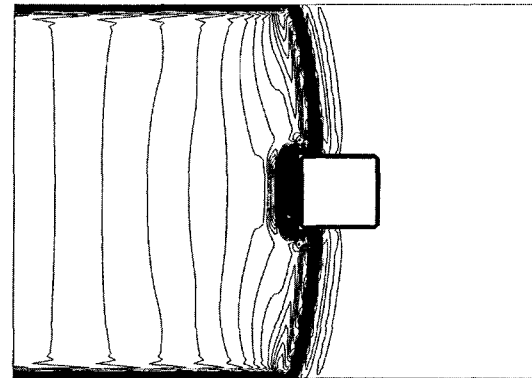

Fig. 6 Results of the speed of shock (by the proposed FDLBM)



(a) 1800 time steps



(b) 2000 time steps

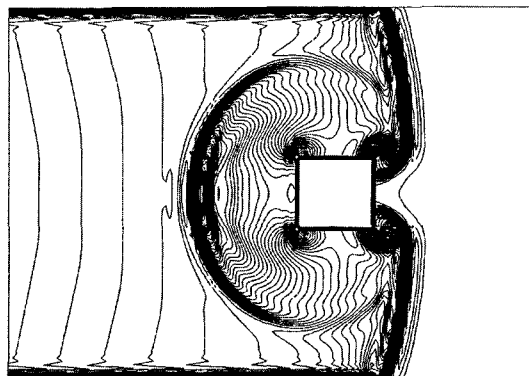

(c) 2200 time steps

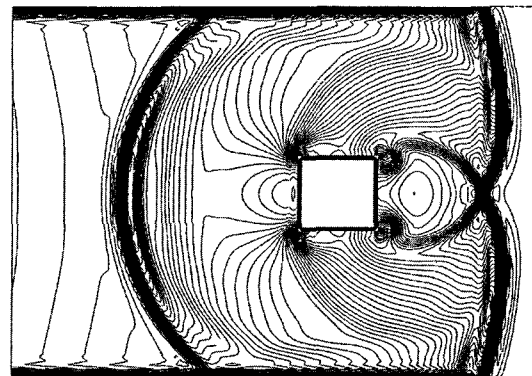

(d) 2400 time steps

Fig. 7 Unsteady shock wave passing through the rectangular column. The shock Mach number  $M_s=2.215$ , initial pressure ratio  $P_4/P_1=25.0$

the results also agree well with the theoretical predictions. Figure 6 shows that the difference between the theoretical shock speed and the calculated is within 1.24%.

In Fig. 7 the unsteady shock wave passing through a rectangular column placed in the low-pressure gas chamber is shown at selected time steps. The initial pressure ratio  $P_4/P_1=25.0$ , the time  $\Delta t=0.1$  and the shock Mach number  $M_s=2.215$  are set as the initial conditions. Both the

shock wave and the reflected wave are also well expressed.

In Fig. 8, the unsteady shock wave passing through a circular cylinder is shown. The radius of the cylinder is equal to the 25 lattice nodes. The initial conditions in this case are the initial pressure ratio  $P_4/P_1=15.0$ , the time  $\Delta t=0.1$  and the shock Mach number  $M_s=2.043$ . The numerical results well express both the unsteady shock wave and the reflected wave at various time steps.

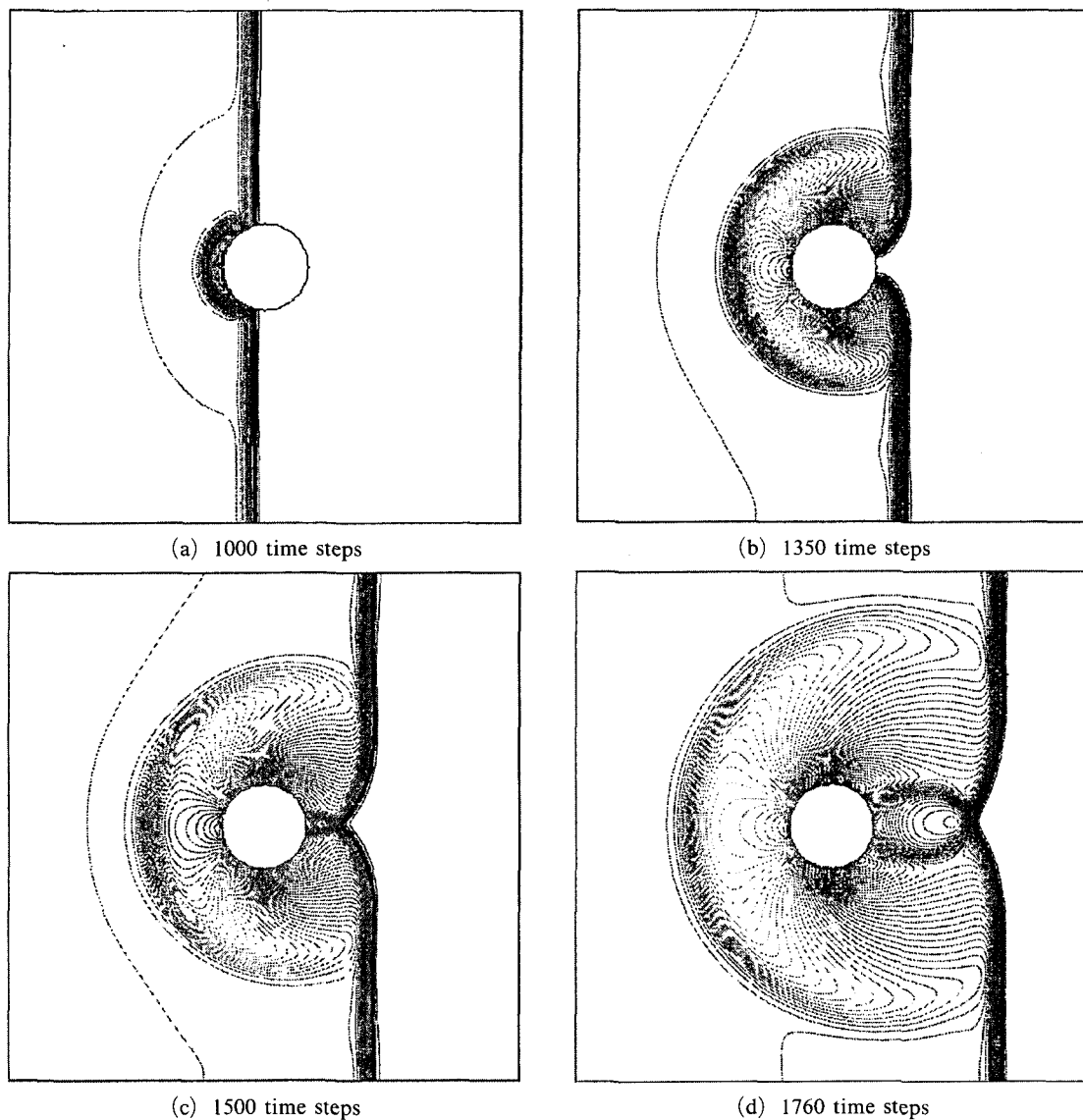

**Fig. 8** Unsteady shock wave passing through the circular cylinder. The shock Mach number  $M_s=2.043$ , initial pressure ratio  $P_4/P_1=15.0$



## 6. Conclusions

By applying the lattice BGK compressible fluid model with the finite difference method, the calculation of flow field such as strong shock wave where a large pressure ratio exists has been successful in the present study. A new model has been also proposed in FDLBM for the purpose of stabilizing the numerical scheme and speeding up the calculation.

In applying the model to shock tube problem, we compared the theoretical and the numerical results. The numerical results with the newly proposed FDLBM show better agreement with the theoretical predictions than the conventional model. Also, both the shock wave and the reflected wave are well expressed with the proposed model in some example cases.

## Acknowledgment

This work was supported by the Brain Korea 21 Project.

## References

- Alexander, F. J., Chen, S. and Sterling, J. D., 1993, "Lattice Boltzmann Thermo-Hydrodynamic," *Physical Review E*, 47, pp. 2249~2252.
- Cao, N., Chen, S., Jin, S. and Martinez, D., 1997, "Physical Symmetry and Lattice Symmetry in the Lattice Boltzmann Method," *Physical Review E*, 55, pp. R21~R24.
- Chen, Y., Ohashi, H. and Akiyama, M., 1994, "Thermal Lattice Bhatnagar-Gross-Krook Model without Nonlinear Deviations in Macrodynamic Equation," *Physical Review E*, 50, pp. 2776~2783.
- Hung, J., Xu, F., Vallieres, M., Feng, D. H., Qian, Y. H., Fryxell, B. and Strayer, M. R., 1997, "A Thermal LBGK Model for Large Density and Temperature Differences," *International Journal of Modern Physics C*, Vol. 8, No. 4, pp. 827~841.
- McNamara, G. and Zanetti, G., 1988, "Use of the Boltzmann Equation to Simulate Lattice-Gas Automata," *Physical Review Letters*, Vol. 61, pp. 2332~2335.
- Qian, Y. H., Succi, S. and Orszag, S. A., 1995, "Recent Advances in Lattice Boltzmann Computing," *Annual Review of Computational Physics III*, D. Stauffer ed. World Scientific, pp. 195~242.
- Rothman, D. and Zaleski, S., 1997, *Lattice-Gas Cellular Automata*, Cambridge UP.
- Tsutahara, M. and Kang, H. K., 2002, "A Discrete Effect of the Thermal Lattice BGK Model," *Journal of Statistical Physics*, Vol. 107, No. 112, pp. 479~498.