

An Experimental Study on the Combustion Characteristics of a Low NO_x Burner Using Reburning Technology

Kook-Young Ahn*, Han-Seok Kim

*Eco-Machinery Engineering Department, Korea Institute of Machinery & Materials,
Jang-Dong 171, Yusung-Ku Taejon, 305-343, Korea*

Min-Gyu Son, Ho-Keun Kim, Yong-Mo Kim

*Department of Mechanical Engineering, Hanyang University, 17, Haengdang-Dong,
Seongdong-Ku Seoul 133-792, Korea*

The combustion characteristics of a low NO_x burner using reburning technology have been experimentally studied. The reburn burner usually has three distinct reaction zones which include the primary combustion zone, the reburn zone and the burnout zone by provided secondary air. NO_x is mainly produced in a primary combustion zone and a certain portion of NO_x can be converted to nitrogen in the reburn zone. In the burnout zone, the unburned mixtures are completely oxidated by supplying secondary air. Liquefied Petroleum Gas (LPG) was used as main and reburn fuels. The experimental parameters investigated involve the main/reburn fuel ratio, the primary/secondary air ratio, and the injection location of reburn fuel and secondary air. When the amount of reburn fuel reaches to the 20-30% of the total fuel used, the overall NO reduction of 50% is achieved. The secondary air is injected by two different ways including vertical and parallel injection. The injector of secondary air is located at the downstream region of furnace for a vertical-injection mode, which is also placed at the inlet primary-air injection region for a parallel-injection mode. In case of the vertical injection of the secondary air flow, the NO_x formation of stoichiometric condition at a primary combustion zone is nearly independent of the reburn conditions (locations, fuel/air ratios) while the NO_x emission of the fuel-lean condition is considerably influenced by the reburn conditions. In case of the parallel injection of the secondary air, the NO_x emission is sensitive to the air ratio rather than the fuel ratio and the reburning process often coupled with the multiple air-staging and fuel-staging combustion processes.

Key Words : Low NO_x Burner, Reburning, NO_x formation, N₂ conversion, Swirl

1. Introduction

Due to the increasingly tighter emission regulations, the NO_x control technologies have become more sophisticated. Among the NO_x reduction technologies, it is generally well-known

that the reburning method effectively reduce the NO_x emission in the coal combustion process. This reburning concept was first proposed by Wendt et al. (1973). In their reburning approach, nitrogen oxides are converted to nitrogen by injecting the clean secondary fuel into the downstream region of the primary substoichiometric combustion zone. Myerson (1974) suggested the reduction mechanism of nitric oxide by hydrocarbons. In the early 1980s, researchers at Mitsubishi first applied the reburning concept to a full-scale boiler and more than 50% reduction of NO was achieved (Smart & Morgan, 1994).

* Corresponding Author,

E-mail : kyohn@kimm.re.kr

TEL : +82-42-868-7324; **FAX :** +82-42-868-7284

Eco-Machinery Engineering Department, Korea Institute of Machinery & Materials, Jang-Dong 171, Yusung-Ku Taejon, 305-343, Korea. (Manuscript Received April 2, 2001; Revised April 15, 2002)

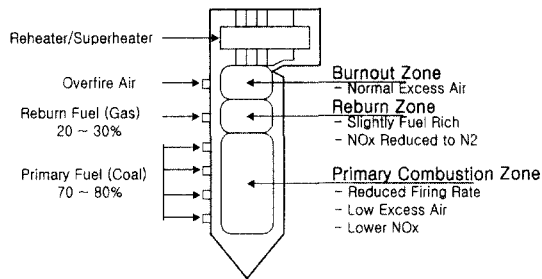

Fig. 1 Schematic diagram of the boiler using the reburning process

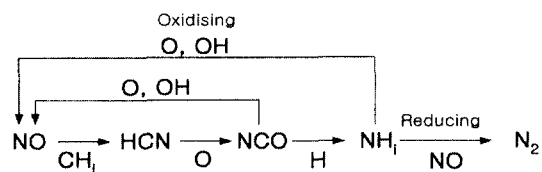

Fig. 2 Reaction pathways in the reburning process

Recently, in order to increase the NO reduction efficiency, Large-scale application (Smart & Weber, 1989) and AR (advanced reburning) (Lanigan et al., 1995) have been quite popular.

In the reburn-based boiler shown in Fig. 1, the reburn burner usually has three distinct reaction zones which include the primary combustion zone, the reburn zone and the burnout zone by a provided secondary air. NO_x is mainly produced in a primary combustion zone and a certain portion of NO_x can be converted to nitrogen in the reburn zone. In the burnout zone, the unburned mixtures are completely oxidated by supplying secondary air. Figure 2 shows the reaction pathways involved in the reburn process. NO formed in the primary combustion zone is quickly converted to HCN by reacting with hydrocarbon radicals (CH_i) which are generated in the reburn process (Lyerson, 1974). The fast conversion of HCN to NH_i subsequently occurs. NH_i then forms NO by reaction with an O or OH radical or creates N₂ by reacting with NO. The path favoured for the reaction of the NH_i radical is determined by the flame temperature and equivalence ratio. Under globally fuel-rich conditions the reaction is leading to N₂ formation while the reaction pathways leading to NO are

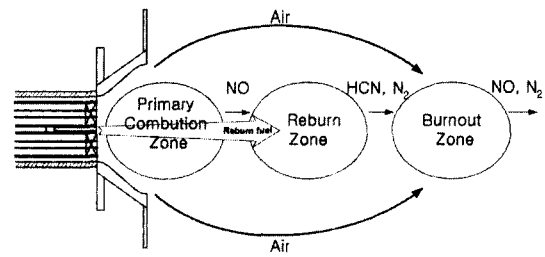

Fig. 3 Schematic diagram of a reburning process in the model burner

dominant in an oxidizing environment.

Unlike the conventional reburning systems, in this study, the reburning process has been applied to an coaxial swirling gas-fired burner where the reburn fuel is supplied by penetrating the central region of primary combustion zone and the aerodynamically controlled secondary air is supplied to the burnout zone. The schematic diagram of the present reburning process is illustrated in Fig. 3. Experiments have been carried out for the wide range of key design parameters including the reburn fuel injector position, reburn fuel fraction, primary and secondary air ratio. Effects of these parameters on the NO_x emission characteristics are discussed in detail.

2. Experimental Setup

2.1 Burner

Figure 4 shows the configuration and dimension of the burner utilizing the reburning process. The capacity of this burner is about 232.6kW(th) and LPG is used as the main and reburning fuels. The burner consists of the primary and secondary air and fuel supply devices. The primary air was supplied through 45°vane angle swirler for flame stability. The secondary air supplying for the burnout zone is injected by two different ways; (a) vertical injection at downstream region ($x=1.3\text{m}$) of the combustor and (b) parallel injection at the primary air inlet location, and the swirl strength can be adjusted by using the movable block swirl generator. The six-hole fuel nozzle is located on the central zone of the annular primary-air swirler for the efficient mixing. A reburn fuel nozzle is installed at the burner center

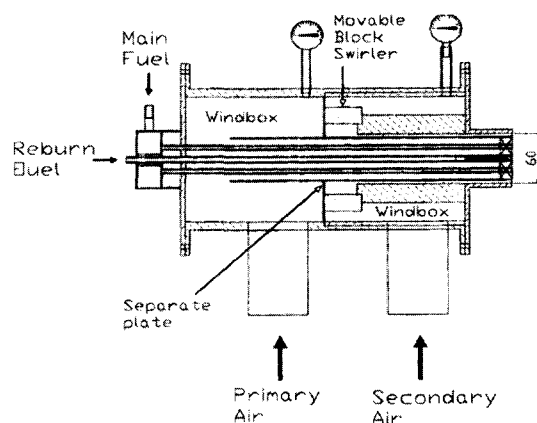

Fig. 4 Detailed configuration of burner

and the reburn fuel jet has the sufficiently high injection velocity for penetrating the swirl-induced toroidal recirculation zone of the primary flame field. Experiments are performed for the various injector locations (0, 6, 12 and 18 cm) from inlet.

2.2 Furnace and quarl

The cylindrical furnace has been utilized. The inside diameter and overall length are 0.6 m and 3.5 m, respectively. The thickness of an insulating material is 40 mm. At every 10 cm along the right furnace wall, ports are equipped for sampling the gases and injecting the probes. Two view windows are installed at the left wall and the rear side of furnace. For cooling the furnace wall and controlling the furnace temperature, the water cooling coil is densely wound along the wall. For the effective control of the secondary air vortex, the diverging burner quarl was utilized. In terms of the dimension and geometry of this diverging quarl, its length is 60 mm, and diameter ratio (L/A) and a quarl expansion ratio (B/A) are 1.0 and 2.0, respectively. At the upstream and downstream edge, this quarl has the non-diverging section with the zero angle. In this study, the quarl was designed to fit a third-order polynomial profile subject to these geometric effects of quarl edges (Wendt, et al., 1973).

2.3 Measurements

Rotameters are used to measure the air and fuel

Table 1 Experimental conditions

Total air flow rate	312.9 kg/h
Total fuel flow rate	18.067 kg/h
Air temperature	30°C
Fuel temperature	11°C
λ (Excess air ratio)	1.1

flow rate. Three types of thermocouples are used for measuring temperature. The T-type thermocouple is adopted to measure the air and fuel temperatures and the R-type thermocouple is used to measure the centerline profile of temperature and the temperature distribution in the reburn zone. For measuring the temperature at stack, the K-type thermocouple is utilized. The emission level of the combustion gas sampled with water-cooling steel probes are determined by an electrochemical type gas analyzer (Greenline MK2). According to experimental conditions listed in Table 1, experiments are carried out for the wide range of operating conditions including the main/reburn fuel ratio, the primary/secondary air ratio. Throughout these experiments, the total fuel and airflow rates are fixed at excess air ratio 1.1.

2.4 Secondary air injection method

In the present reburning burner, the secondary air is injected by two different ways including vertical and parallel injection. The schematic diagrams of these two different injection modes are presented in Fig. 5. In a vertical-injection arrangement, the secondary air device is installed in 1.3 m downstream of the experimental furnace and the air is vertically injected through the rounding nozzle. The reburn fuel is injected at the downstream region ($x=18$ cm) of the primary combustion zone and this injection arrangement constitutes the Reburn-Mode I which creates three distinct reaction zones. On the other hand, for a parallel-injection mode, the injector of secondary air is placed at the inlet primary-air injection region. The secondary air was parallelly injected at the primary air inlet location, and this arrangement establishes the Reburn-Mode II.

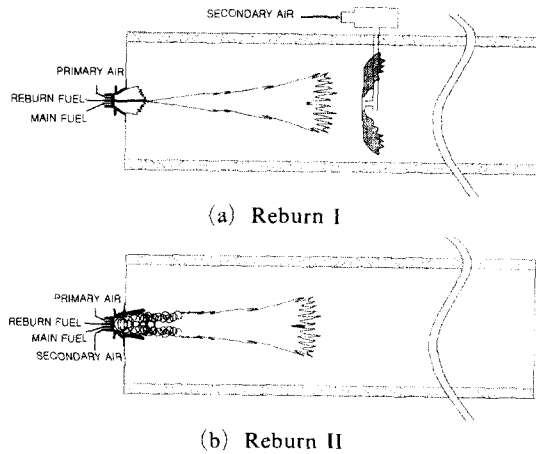

Fig. 5 Sketch of the reburn-mode I and II

3. Results and Discussion

In order to systematically investigate the effect of reburning on combustion processes and NO_x emission, experiments have been performed for the wide operating condition of governing parameters including the reburn fuel injector position, reburn fuel fraction, primary and secondary air ratio. A baseline case is corresponding to the 0% reburning fuel injection. In this case, no secondary air is injected and all the combustion air is passed through the primary air supply route. The resulting NO_x emission level is about 62ppm and the O₂ concentration in the flue gas is 2%.

3.1 Combustion characteristics of reburn I

Figure 6 shows the effect of reburn fuel fraction on NO emission for the different locations of reburn fuel injector. By increasing the fraction of reburn fuel up to 20%, the NO_x emission level rapidly decreases as reburn fuel fraction increases to 20%. When the fraction of reburn fuel is reached around at 20-30%, the overall NO emission level is decreased more than 50%. In case of the reburn fuel fraction larger than 20%, the NO emission is relatively insensitive to the fraction of reburn fuel. These results suggest that the optimum condition of reburn fuel fraction lies around between 20% and 30%. It is also found that the location of reburn fuel injector marginally influences the NO emission.

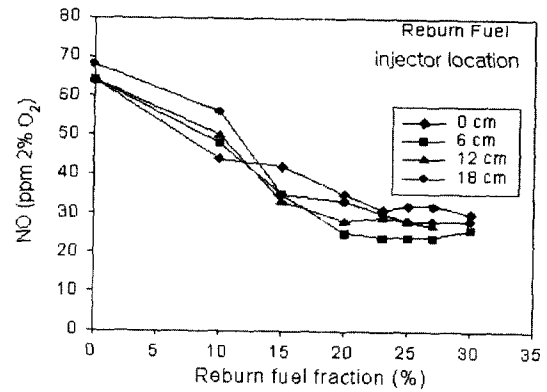

Fig. 6 Effect of the reburn-fuel fraction on NO_x emission

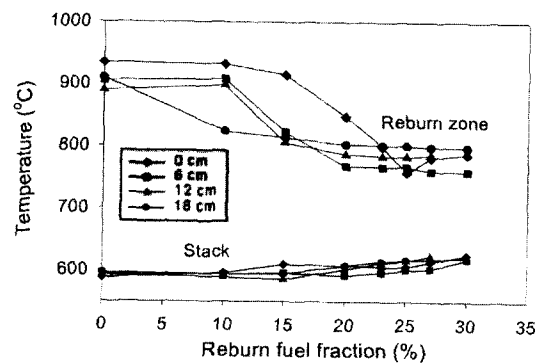

Fig. 7 Temperature versus reburn-fuel fraction at reburn and stack zone

Figure 7 presents the corresponding temperatures of stack and reburn zone in four different locations of reburn fuel injector. Experimental data clearly indicate that, by increasing the fraction of reburn fuel, the gas temperature at the reburn zone decreases and the flue gas temperature increases. This trend is mainly related to the increased levels of unburned fuel in the reburn zone which yields the decrease of flame temperature. As a result, the fraction of unburned fuel oxidized in the burnout zone is gradually increased and the flue gas temperature is slightly increased.

Figure 8 shows the effect of reburn fuel increment on NO emission. The increased flow rate of the reburn fuel results in increasing the injection velocity of reburn fuel. Except the initial increase of the reburn fuel flow rate up to 7%, it

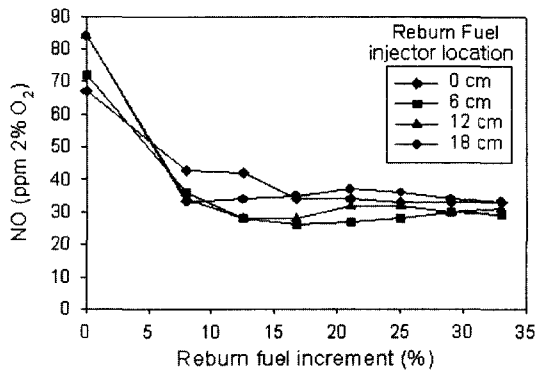

Fig. 8 NOx emission level versus reburn-fuel increment

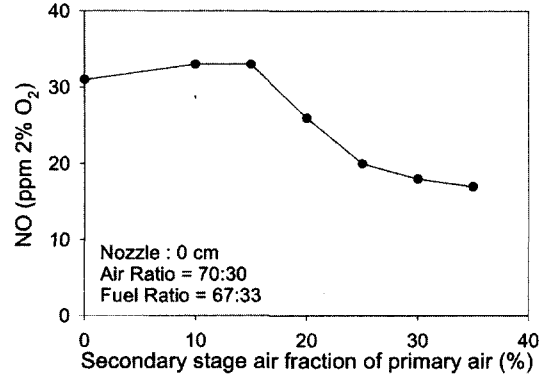

Fig. 10 NOx emission level versus the primary-second air flow ratio

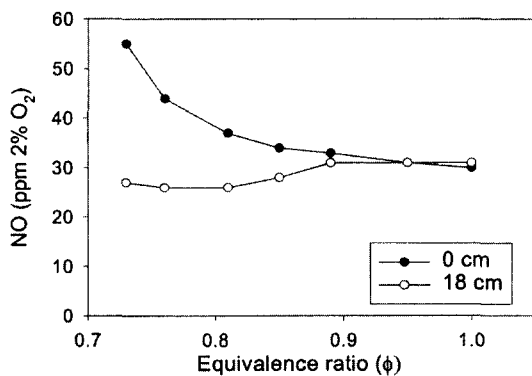

Fig. 9 Effect of primary-zone stoichiometry on NOx emission

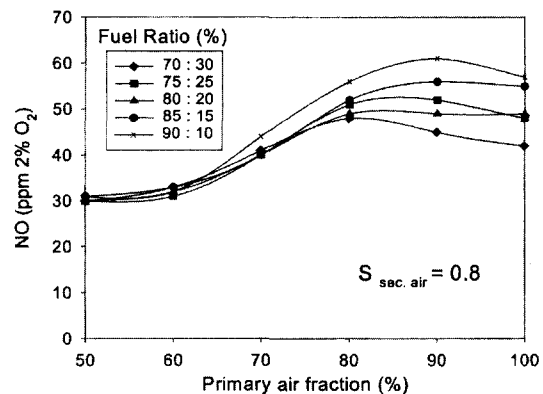

Fig. 11 Effect of primary-air fraction on NO emission

is observed that the NOx emission level is relatively insensitive to the injection velocity and location of the reburn fuel. These results suggest that the increased injection velocity of reburn fuel does not contribute to enhance the mixing between the injected reburn fuel and the products of primary combustion zone. Thus, the high turbulence intensity created at the Internal Recirculation Zone (IRZ) dominates the mixing process between the primary-zone products and the reburn fuel (Smart et al. 1994).

Figure 9 displays the effect of the overall equivalence ratio of primary zone on the NOx emission. In this case, experimental data are obtained by increasing the airflow rate in primary combustion zone while maintaining the fixed ratio (67:33) for the primary and reburn fuel. When the injector of reburn fuel is placed at $x=18\text{cm}$,

the NO emission is nearly independent of the equivalence ratio in the primary combustion zone. In this case, at the downstream region of primary flame, the reburn fuel is injected and mixed with the primary-zone products. Thus, the increase of primary airflow rate results in the decrease of flame temperature and NO production rate. As a result, the conversion rate of NO into N_2 at the reburn zone decreases and the NO emission level is nearly invariable with increasing the mass flow rate of primary air. However, when the reburn-fuel injector is installed at the inlet ($x=0\text{cm}$), the NO emission drastically increases by increasing the primary airflow rate and decreasing the equivalence ratio in the primary zone. In this condition, it is quite possible that the injected reburn fuel penetrating through the primary combustion zone, partial reburn fuel is

partially combusted in the primary zone. Since the increase of primary air flow rate is leading to the enhancement of turbulent mixing, the portion of reburn fuel participating in the combustion of primary zone is progressively increasing and the resulting NO emission level increases. The effect of the air staging on NO emission is presented in Fig. 10. As the flow rate of secondary air increases, the turbulent mixing in the primary zone is reduced and the resulting NO emission level substantially decreases. However, when the fraction of secondary air flow rate exceeds the certain value, the flame instability is observed in the experiment.

3.2 Combustion characteristics of reburn II

Figure 11 shows the effect of primary air flow rate on NO emission for different fuel ratios. These data obtained in this study are based on the swirl number, 0.8 of the secondary air flow. When the secondary air is not injected, the NO_x emission level is decreased by increasing the fraction of reburn fuel. At the secondary-air flow fraction larger than 40%, four different fractions of primary and reburn fuel yield the nearly same

minimum NO_x emission level. However, at the relatively small fraction of secondary air flow, the NO emission is sensitive to the primary-reburn fuel ratio. With decreasing the fraction of primary air flow rate, the peak point of the NO emission is shifted to the lower fraction of primary air flow where the stoichiometry of the primary zone is maintained and the corresponding temperature is about the maximum level.

Figure 12 show the effect of reburn fuel fraction on the NO_x emission in three primary-secondary air ratios (9:1, 7:3, 5:5). The centerline profiles of temperature for these three cases is displayed in Fig. 13. In the secondary air flow, experiments are performed for two flow conditions with and without swirl. In case of the relatively low primary-secondary air ratio (AR=1/9), the swirling flow (S_{sec. air}=0.8) marginally influences the NO_x emission and the temperature distribution. By increasing the fraction of reburn fuel, the NO_x emission level is substantially decreased. However, in case of the relatively high primary-secondly air ratios (AR=3/7, 5/5), the NO_x emission is not quite sensitive to the fraction of reburn fuel. These trends are directly tied

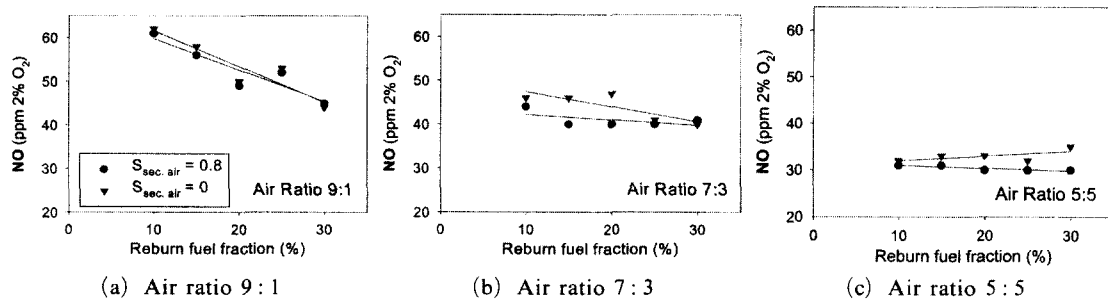

Fig. 12 Effect of reburn-fuel fraction on NO emission

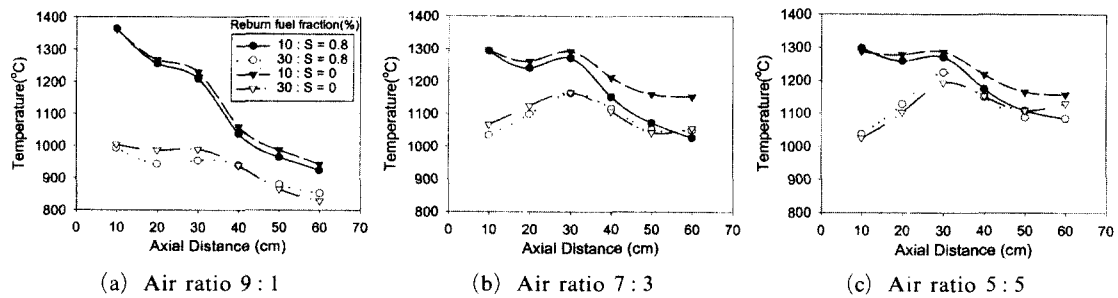

Fig. 13 Temperature distribution on axial direction in reburn fuel Fraction

with the effect of the primary air flow rates discussed above. On the other hand, as shown in Fig. 13, the secondary-air swirl flow does not quite noticeably modify the upstream high-temperature zone ($x < 35\text{cm}$) where most of thermal NO_x is formed. As a result, the secondary swirl flow tested in this study have a minor contribution to the NO_x emission level.

3.3 The comparisons of reburn and no-reburn

Figures 14 and 15 illustrate the photographs of flame pattern for the no-reburn, reburn-I and reburn-II systems and the corresponding axial profiles of NO, CO and O₂ at five radial locations

($r = 2.5, 7.5, 12.5, 17.5, 22.5\text{cm}$). In the no-reburn system, the single flame was formed in the primary combustion zone. It can be clearly seen that most of NO is formed in the upstream region and slightly increases along the downstream region. The distribution of the measured CO concentration implies that the combustion is completed at the certain locations ($x = 20\text{--}30\text{cm}$) of the downstream regions. In case of the reburn-mode I, the photographs evidently reveal the reburning process that consist of the primary combustion zone, the reburn zone, and the burnout zone. In the axial profiles of NO concentration at $r = 2.5\text{cm}$, the NO reduction at the reburn zone is clearly observed. Based on the measured profiles of

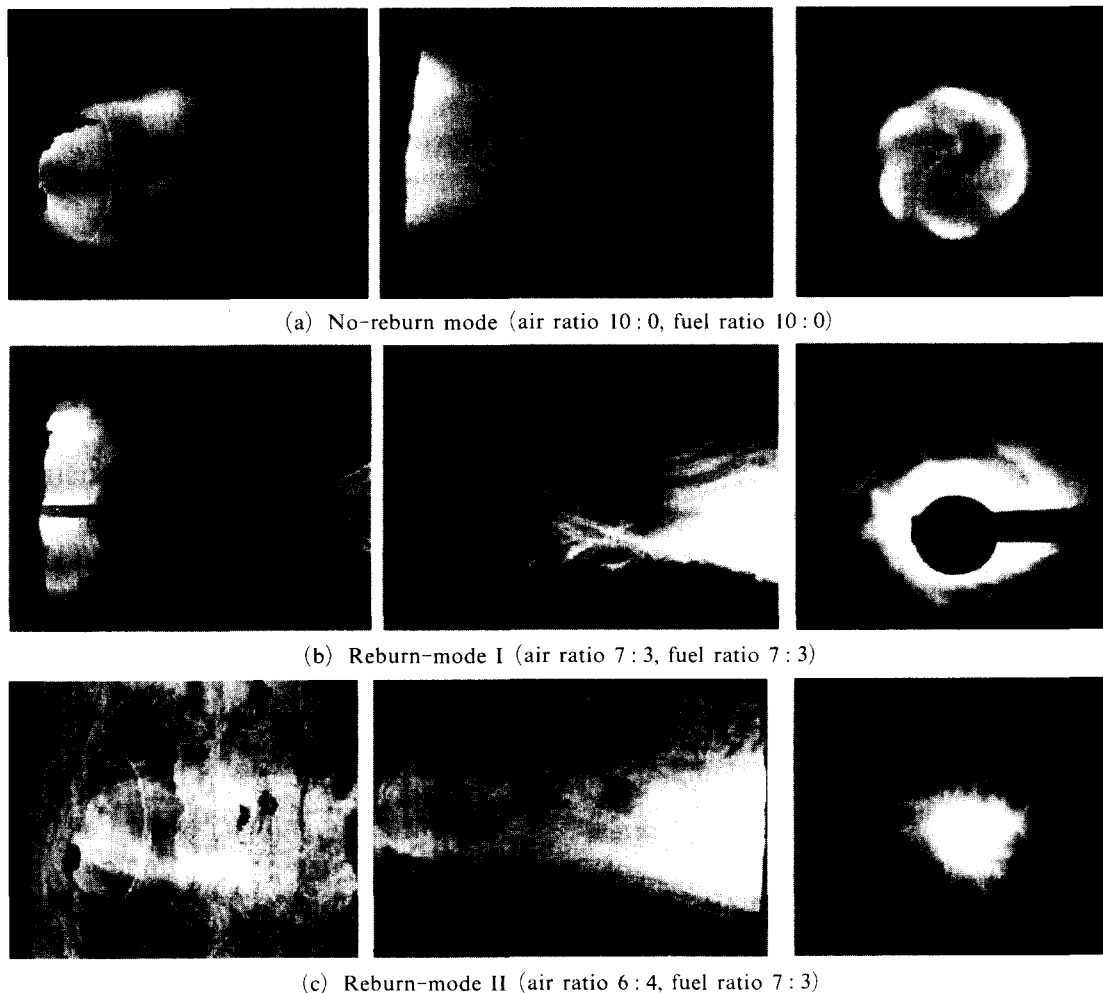

Fig. 14 Photographs of flame pattern for three combustion modes

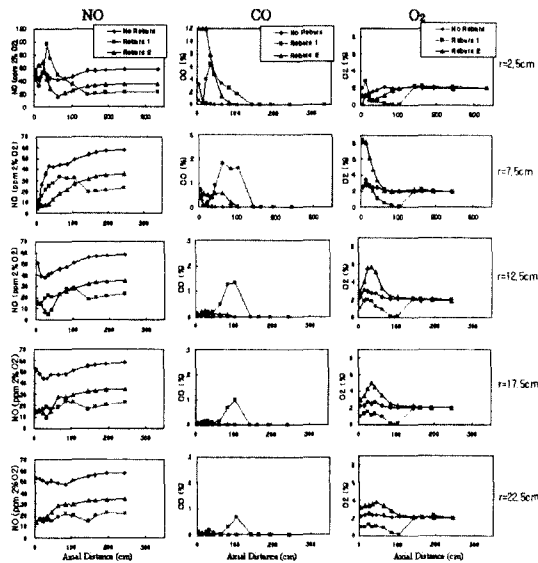

Fig. 15 Emission profile comparison in furnace

CO concentration, It could be speculated that the reburning is processed with the fuel-rich conditions around at the combustion regions ($x=30\sim 130\text{cm}$). Owing to the injection of the secondary air, the O₂ concentration increases and reaches the constant level. In case of the reburn-mode II, the reburn zone having the relatively weak flame is created in the downstream region of the primary flame and the burnout zone aerodynamically controlled by the secondary air inflow is also established. Experimental profiles of NO and CO at $r=2.5$ indicate that the NO reduction is occurred and the reburning is processed with the fuel-lean condition in the reburn-mode II.

4. Conclusion

In order to systematically investigate the effect of reburning on combustion processes and NO_x emission, experiments have been performed for the wide operating condition of governing parameters including the reburn fuel injector position, reburn fuel fraction, primary and secondary air ratio. Based on the experimental results for the reburn combustion systems, the following conclusions can be drawn.

(1) When the fraction of reburn fuel is reached

around at 20–30%, the overall NO emission level is decreased more than 50%. In case of the reburn fuel fraction larger than 20%, the NO emission is relatively insensitive to the fraction of reburn fuel. It is also found that the location of reburn fuel injector marginally influences the NO emission.

(2) Except the initial increase of the reburn fuel flow rate up to 7%, it is observed that the NO_x emission level is relatively insensitive to the injection velocity and location of the reburn fuel. These results suggest that the increased injection velocity of reburn fuel does not contribute to enhance the mixing between the injected reburn fuel and the products of primary combustion zone. Thus, the high turbulence intensity created at the Internal Recirculation Zone (IRZ) dominates the mixing process between the primary-zone products and the reburn fuel.

(3) When the injector of reburn fuel is placed at $x=18\text{cm}$, the NO emission is nearly independent of the equivalence ratio in the primary combustion zone. By increasing the primary airflow rate, the conversion rate of NO into N₂ at the reburn zone decreases and the NO emission level is nearly invariable with increasing the mass flow rate of primary air. However, when the reburn-fuel injector is installed at the inlet ($x=0\text{cm}$), the NO emission drastically increases by increasing the primary airflow rate and decreasing the equivalence ratio in the primary zone.

(4) As the flow rate of secondary air increases, the turbulent mixing in the primary zone is reduced and the resulting NO emission level substantially decreases. However, when the fraction of secondary air flow rate exceeds the certain value, the flame instability is observed in the experiment.

(5) When the secondary air is not injected, the NO_x emission level is decreased by increasing the fraction of reburn fuel. At the secondary-air flow fraction larger than 40%, four different fractions of primary and reburn fuel yield the nearly same minimum NO_x emission level. However, at the relatively small fraction of secondary air flow, the NO emission is sensitive to the primary-reburn fuel ratio.

(6) In case of the reburn-mode I, the experimental results reveal that the reburn process consists of the primary combustion zone, the reburn zone and the burnout zone, and the reburning is processed with the fuel-rich conditions. In case of the reburn-mode II, the reburn zone having the relatively weak flame is created in the downstream region of the primary flame and the burnout zone aerodynamically controlled by the secondary air inflow is also established. The NO reduction is occurred and the reburning is processed with the fuel-lean condition in the reburn-mode II.

References

- Beer, J. M. and Chigier, N. A., 1972, "Combustion Aerodynamics," *John Wiley & Sons, inc.*, pp. 107~117.
- Folsom, B. A., Payne, R., Moyeda, D., Vladimir Zamansky and Golden, J., 1995, "Advanced Reburning with New Process Enhancements," EPRI/EPA 1995 Joint Symposium on Stationary Combustion NOx Control
- Lanigan, E. P., Golland, E. S. and Rhine, J. M., 1995, "The Demonstration of Gas Reburning at Longannet : Leading the World in Low-NOx Technology," *Proceedings-International Gas Reburn Technology Workshop*, pp. D121-138.
- Myerson, A. L., 1974, "The Reduction of Nitric Oxide in Simulated Combustion Effluents by Hydrocarbon-Oxygen Mixtures," *Fifteenth Symposium on Combustion*, pp. 1085~1092.
- Smart, J. P. and Weber, R., 1989, "Reduction of NOx and Optimisation of Burnout with an Aerodynamically Air-Staged Burner and an Air-Staged Precombustor Burner," *Journal of the Institute of Energy*, pp. 237~245.
- Smart, J. P. and Morgan, D. J., 1994, "The Effectiveness of Multi-Fuel Reburning in an Internally Fuel-Staged Burner for NOx Reduction," *Fuel*, pp. 1437~1442.
- Wendt, J. O. L., Sternling, C. V. and Matovich, M. A., 1973, "Reduction of sulfur trioxide and nitrogen oxides by secondary fuel injection," *Fourteenth Symposium on Combustion*, pp. 897~904.