

Characteristics of Exfoliated Graphite Prepared by Intercalation of Gaseous SO₃ into Graphite

Beom-Jae Lee

Eco-machinery Eng. Dept., Korea Institute of Machinery & Materials, Daejeon 305-343, Korea

Received November 2, 2002

The graphite intercalation compounds(GIC) were prepared by a dry process that led to the intercalation from the direct reaction of gaseous SO₃ with flake type graphite. The basal spacing of the GIC was increased from 8.3 Å to 12 in the gallery height. The ejection of interlayer SO₃ molecules by the heating for 1 minute at 950 °C resulted in an exfoliated graphite (EG) with surprisingly high expansion in the direction of c-axis. The expansion ratios of the exfoliated graphites were increased greatly between 220 times and 400 times compared to the original graphite particles, and the bulk density was in the range of 0.0053 to 0.01 g/cm³, depending on reaction time. The pore size distribution of exfoliated graphite was in the range of 10-170 μm, which exhibits both mesoporosity and macroporosities. This result indicates that the direct reaction of graphite particles with gaseous SO₃ can be proposed as an another route for the exfoliated graphite having excellent physical properties.

Key Words : Graphite intercalation compound (GIC), Exfoliated graphite (EG), Oil sorption

Introduction

Exfoliated graphite (EG), which is an important raw material for the industrial production of flexible graphite sheets, sealing, packing and thermal insulator, has attracted attention because of its very high sorption capacity of spilled heavy oils and their easy recovery. Inagaki *et al.*¹⁻³ recently reported that the exfoliated graphite exhibited an excellent adsorption for the spilled oil in water. Graphite intercalation compounds(GIC) as precursors for exfoliated graphite have been studied by using various intercalates, such as H₂SO₄,^{4,5} FeCl₃,^{6,7} K-THF,⁷ formic acid,⁸ etc.⁹ However, in industry, the acid treatments based on the sulfuric acid have been still used as a conventional process leading to the exfoliated graphite. In general, the acid treatment of flake graphite is carried out by the wet process in which the flake graphites are immersed in a strongly oxidizing solution prepared by mixing a concentrated sulfuric acid with an oxidizing agents, such as nitric acid, potassium chromate, potassium permanganate, hydrogen peroxide etc. Therefore, the discharge of a great quantity of acid waste and its treatment have been pointed out to be troublesome; admixtures of strong acid are troublesome in a process control because of their strongly corrosive property.

SO₃ gas molecules, as an excellent oxidizing agent, can be intercalated into interlayers to attack directly π -electron in the interlayer of graphite. The direct reaction of flake graphite with SO₃ gas can be processed by dry process where SO₃ gas is fed through the reactor filled with the graphite particles in an atmospheric condition. In particular, SO₃ gas can be supplied by using a byproduct in a chemical process, and the problem of generation of acid waste can be eliminated in this process, therefore, this could solve a problem in the process caused by treating a corrosive and strong acid admixtures in wet process. In spite of this good

point, research on using SO₃ gas as an intercalation oxidizer has not nearly been conducted.

In this paper, the preparation of exfoliated graphite by the reaction of flake graphite with SO₃ gas is reported. The exfoliated graphite prepared by our novel method exhibited no difference in the physical properties, such as the volume expansion, the bulk density, and the oil sorption, compared with that manufactured by the acid immersion method. This result indicates that the dry process can be very effective route leading to the exfoliated graphite.

Experimental Section

Raw materials used were natural graphite particles(98%, 50 mesh, Hyundai Coma Ind. Co., Korea) and oleum (25% SO₃, Namhae Chem., Korea) as a SO₃ source.

The reaction of graphite particles with SO₃ gas, as shown in Figure 1, was conducted by passing SO₃ gas through the reactor filled with the graphite particle in an atmospheric condition. SO₃ gas was evaporated by heating at 80-120 °C the flask filled with 500 mL of oleum, saturating the upper reactor filled with graphite particle with SO₃ gas. The saturation of SO₃ gas in a reactor can be ascertained by opening the cock valve connected to the right upper part of reactor. The temperature of the reactor was kept above 25 °C to prevent the SO₃ gas freezing. The intercalation reaction was carried out for 5, 10, 15, and 20 hr to prepare SO₃ intercalated graphites.

The amount of SO₃ loaded in the graphite was calculated from the weight increase of reaction products as a function of a reaction time. Each reaction products before weighing were heated for 1 hr at 100 °C to remove SO₃ molecules simply condensed in the graphite surface. The severe heating of graphite intercalation compounds for 1 min at 950 °C brought about an abrupt ejection of interlayer SO₃ gas.

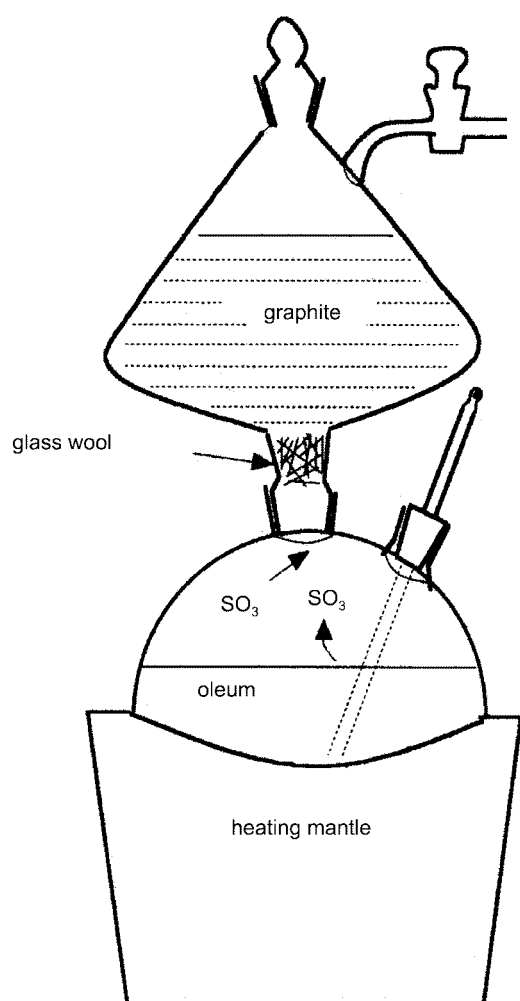

Figure 1. Reaction equipment for the reaction between graphite and SO_3 gas.

resulting in the exfoliated graphite. The bulk density was calculated from the volume and the weight, and the volume expansion ratio was determined from the density ratio of exfoliated graphite and raw graphite. The volume of exfoliated graphites was measured in a mass cylinder by treating the exfoliated graphite for 30 s by the ultrasonic to give uniform packing of exfoliated graphite. To study the sorption capacity of exfoliated graphite, four grades of heavy oil were used, such as crude oil, Bunker-A (viscosity of 0.2–0.4 kg/ms), Bunker-B (1:1 mixture of Bunker-C and Bunker-A, viscosity of 15 kg/ms) and Bunker-C (viscosity of 35 kg/ms).

To distilled water, about 400 mL in a beaker, kept at a room temperature, heavy oil was added and stirred for a while. The exfoliated graphite was added until the floated heavy oil was disappeared from the water surface, completely absorbed in the exfoliated graphite. By changing the weight ratio of heavy oil to that of the exfoliated graphite, the maximum sorption capacity of the exfoliated graphite was determined. The sorption capacity was expressed by the weight of heavy oil sorbed per 1 g of exfoliated graphite.

The intercalation of SO_3 molecules into graphite interlayer

was ascertained by the X-ray diffraction using a Rigaku diffractometer equipped with Cu radiation. Samples were ground to powder before the analysis. The surface morphology of the exfoliated graphite was examined with a scanning electron microscope (SEM, JEOL JSM-840). The total pore volume was measured by a mercury porosimeter (Shimazu-Micrometrics, Poresize-9320, Japan).

Results and Discussion

The blue color is appeared on the graphite particles by initial contact with SO_3 gas and it changes gradually to bluish green color, resulting in a volume expansion about 2–3 times. The wetting of the graphite of blue color was progressively proceeded for initial 5 hr from the bottom of the reactor to the upper part. The successive reaction resulted in a great volume expansion. This indicates that SO_3 gas is initially adsorbed or condensed in the surface of graphite particle and progressively intercalated into interlayers of the graphite.

Figure 2 shows the amounts of loaded SO_3 per g-graphite, which depend on the reaction time. The data represent the amount of intercalated SO_3 only because SO_3 molecules simply adsorbed or condensed on the surface were fully removed by heating for 1 hr at 100 °C. The amount of loaded SO_3 steeply increased for 10 hr and converses to constant, implying that the intercalation was nearly completed after 10 hr.

Figure 3 exhibits the X-ray powder diffraction patterns for the graphite intercalation compounds prepared by the reaction of graphite with SO_3 gas for 5, 10, 15, and 20 hr, respectively. The basal spacing of 3.7 Å in a raw graphite increased to 12.0 Å with a little shift of main peaks after 5 hr reaction, indicating the expansion of 8.3 Å in a gallery height. The gallery height was calculated from the difference in basal spacings of GIC and raw graphite. The basal spacing of a raw graphite is just equal to a layer thickness in graphite. This value was two times larger than the value (~4.6 Å) in

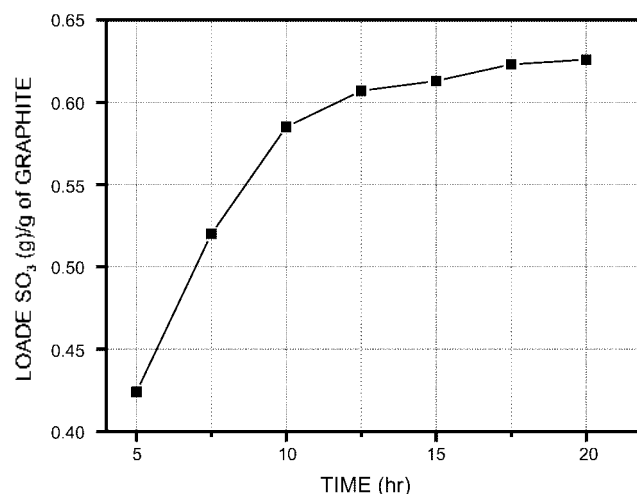

Figure 2. Loaded SO_3 gas per g-graphite depending on the reaction time.

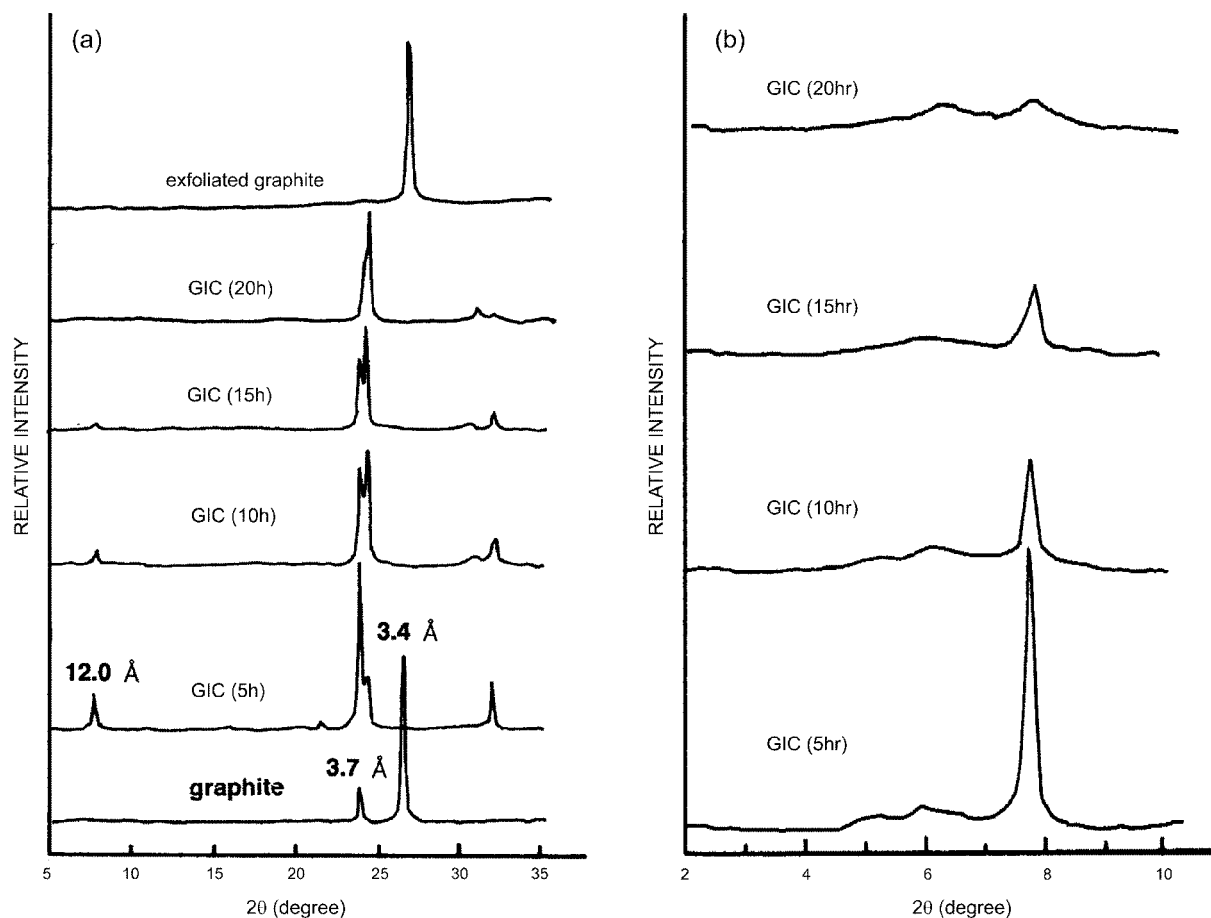

Figure 3. X-ray diffraction patterns of the SO_3 intercalated graphite at various reaction times: (a) 2θ : 5-35, (b) θ : 2-10.

residue compound of sulfuric acid reported previously.¹⁰ The 001 diffraction in GIC, however, as shown in Figure 3(b), gradually disappeared with an increasing reaction time, implying the expansion of graphite layers. This indicates that SO_3 molecules may be packed with configuration of double or multiple layers in the interlayer. Strong van der Waals interaction between SO_3 molecules may lead to large expansion in the gallery height by the interlayer condensation, which reduces the interlayer interaction enough to make exfoliated graphite layers. This explanation is based on that interlayer interaction among graphite layers, and the interlayer interaction is very weak compared with that of other layered materials. The intense peak near ~ 3.5 Å in a raw graphite was known as 001 diffraction.

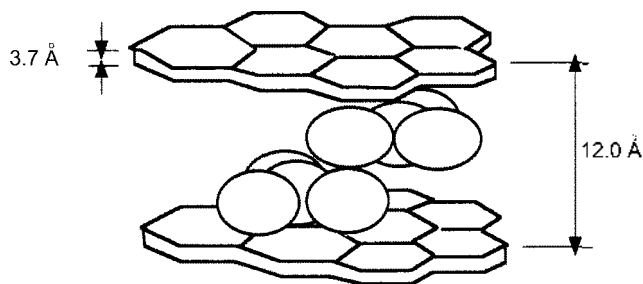

Figure 4. Schematic draws for the hypothetical configuration of SO_3 molecules in the graphite interlayer.

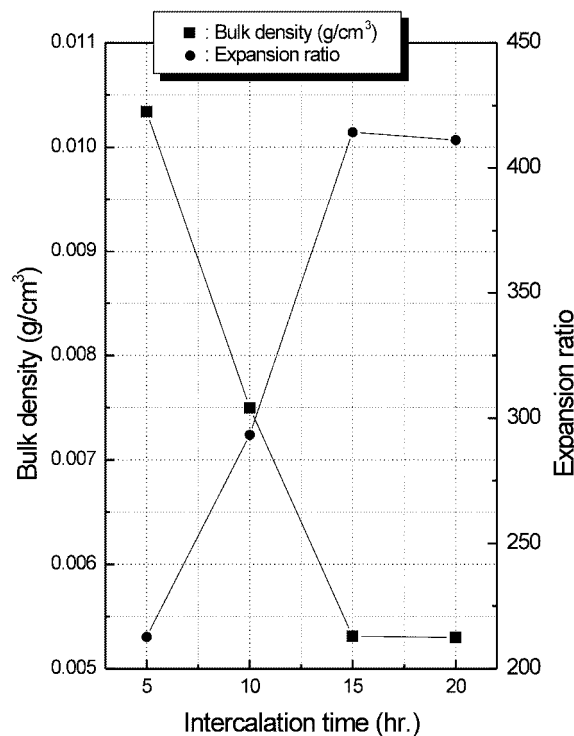

Figure 5. Bulk density and expansion ratio of the exfoliated graphite depending on the reaction temperature.

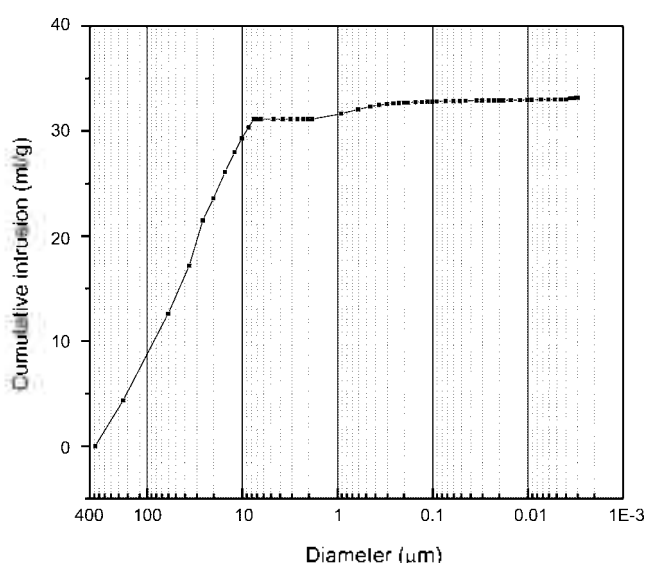

Figure 6. Pore characteristic of the exfoliated graphite by the mercury porosimetry.

Figure 4 shows the hypothetical configuration for SO_3 molecules in interlayer. Supposed that two SO_3 molecules with trigonal planar structure are laid one upon another, the

thickness of SO_3 molecular layers composed of double layer is calculated to be 6.52–7.44 Å, because van der Waals radius of sulfur and oxygen atom is 1.86 Å and 1.40 Å, respectively. This value is similar to the gallery height (8.3 Å) of GIC.

Figure 5 exhibits the bulk density and expansion ratio of the exfoliated graphite with reaction time. The bulk density and the expansion ratio becomes constant as $\sim 0.0053 \text{ g/cm}^3$ and ~ 400 , respectively, after 15 hr reaction, corresponding to the maximum intercalation of SO_3 into graphite interlayer. This result compared with that in a residue compound of sulfuric acid, proving a practical reaction of SO_3 molecules with π -electron in graphite interlayer. The introduction of SO_3 molecules into the graphite layer can not be achieved by the direct immersion of graphite in concentrated sulfuric acid itself. SO_3 molecules in sulfuric acid can not interact with the π -electron in graphite interlayer, because it already taken a needed electron from the water molecules.

Figure 6 exhibits the pore characteristic of the exfoliated graphite determined by mercury porosimetry. Here, the exfoliated graphite was prepared by the reaction for 15 hr. Pore size was mainly in the range of 10–170 μm with $3.3 \times 10^{-2} \text{ m}^3/\text{kg}$ of pore volume. This pore property, as shown in Figure 7, was well proved in surface morphology. Exfoliated structure to prove full expansion among each plates is

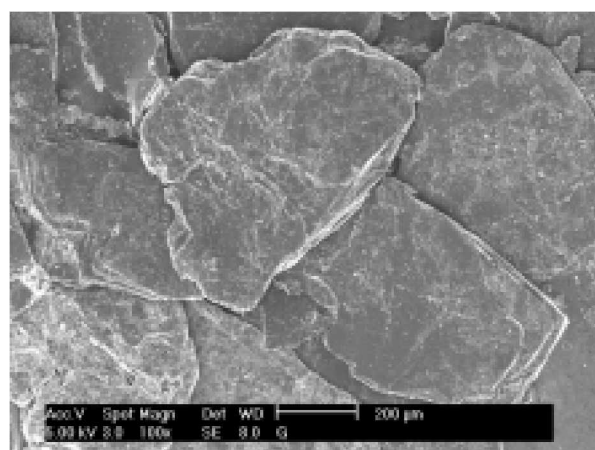

(b) $\times 100$

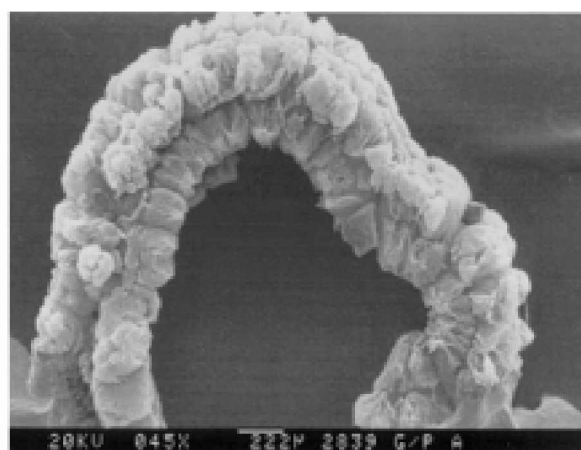

(b) $\times 45$

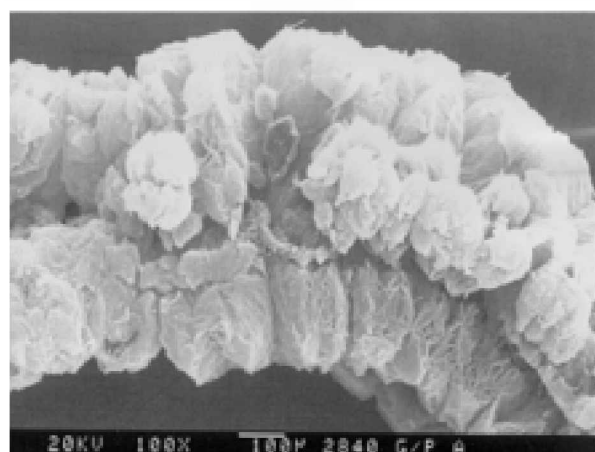

(c) $\times 100$

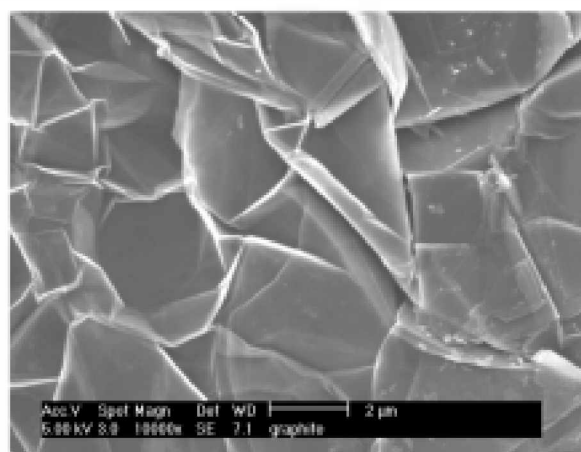

(d) $\times 10,000$

Figure 7. SEM (scanning electron micrographs) for exfoliated graphite.

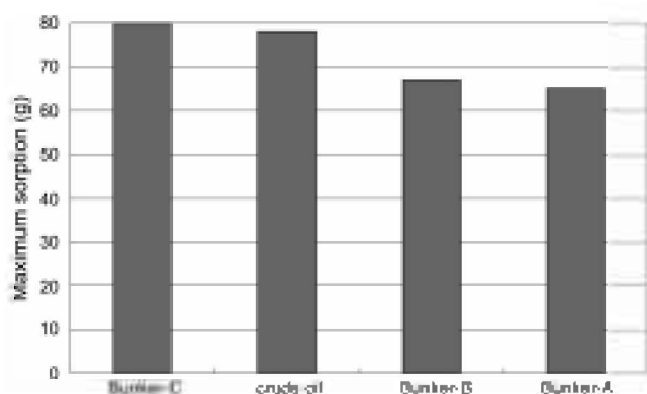

Figure 8. Maximum sorption capacity of the exfoliated graphite for different grade heavy oil.

exhibited well in surface morphology, resulting in a numerous and complicated open canals. This macropore can be more useful for the absorption of oil with more viscous and large molecular weight. In particular, the absorption into exfoliated graphite with macroporous and highly hydrophobic property can be rapidly performed to large amount of oil resulted from capillary condensation. In figure 8, the maximum sorption capacity in this exfoliated graphite with bulk density 0.0053 g/cm^3 was found to be 80 g of bunker-C, 78 g of crude oil, 67 g of bunker-B and 65 g of bunker-A per 1 g of exfoliated graphite, respectively, and the adsorption completed within several minutes. The adsorbed quantity is in direct proportion to the viscosity and molecular weight of oily class. It depends on the macro porous structure in exfoliated graphite. The adsorbed capacity of oily materials is far above exfoliated graphite's pore volume. Shen *et al.* explained this result by exfoliated graphite's unique "winding and adsorbing space".¹¹ After adsorbing heavy oil, exfoliated graphite's particles form into "lumps" which are visible to the naked eye. It was caused by changing exfoliated graphite's internal stress during the adsorption. The dexfoliated graphite particles mesh with each other, took a shape of lump and formed additional adsorbing space. The sizes of the lump and "winding and adsorbing space" were related with exfoliated graphite's porous structure, surface tension between exfoliated graphite and absorbing agent and cohesion of absorbing agent itself.

In conclusion, this result indicates clearly that the direct reaction of SO_3 gas with the graphite particle can be another route leading to the exfoliated graphite with excellent physical properties. This process can utilize SO_3 gas which can be produced as the byproduct in a chemical process, proceed without discharge of acid waste, and solve a problem in the process caused by treating a corrosive and strong acid admixtures in wet process. In particular, intercalated SO_3 molecules may have a role as seducer to take a numerous organic and inorganic molecules into

graphite interlayer because of their strong reactivity. This success of SO_3 gas implies that another oxidative gases can be used for the preparation of exfoliated graphite.

Conclusion

The direct reaction of SO_3 gas with the graphite particle resulted in GIC with 8.3 \AA in gallery height, which indicates that SO_3 molecules can configure with double or multiple layers in the interlayer. The maximum intercalation of SO_3 into graphite interlayer was completed after 15 hr reaction. The severe heating of GIC obtained from the reaction for 15 hr resulted in producing exfoliated graphite. The bulk density and expansion ratio of exfoliated graphite were $\sim 0.0053 \text{ g/cm}^3$ and ~ 400 , respectively. Pore size was mainly in the range of $10\text{-}170 \text{ \mu m}$, and $3.3 \times 10^{-2} \text{ m}^3/\text{kg}$ of pore volume. Surface morphology well exhibited exfoliated structure to prove full expansion among each plate, showing a numerous and complicated open canals. The maximum sorption capacities in exfoliated graphite with bulk density 0.0053 g/cm^3 were found to be 80 g of bunker-C, 78 g of crude oil, 67 g of bunker-B and 65 g of bunker-A per 1 g of exfoliated graphite, respectively, and the adsorption completed within several minutes. This result indicates that the direct reaction of graphite particles with gaseous SO_3 can be proposed as an another route for the exfoliated graphite having excellent physical properties

References

- Kang, F. Y.; Inagaki, M.; Shen, W. C.; Cao, N. Z.; Gu, J. L. *Adsorption Behavior of Heavy Oil on Exfoliated Graphite*. International Symposium of Carbon, 1998; p 295.
- Toyoda, M.; Moriya, K.; Aizawa, J.; Inagaki, M. *Sorption and Recovery of Heavy Oil by Using Exfoliated Graphite*. International Symposium of Carbon, 1998; p 356.
- Toyoda, M.; Inagaki, M. *Carbon* **2000**, *38*, 199.
- Avdeev, V. V.; Martynov, I. Y.; Nikol'skaya, I. V.; Monyakina, L. A.; Sorokina, N. E. *J. Phys. Chem. Solids* **1996**, *57*, 837.
- Avdeev, V. V.; Sorokina, N. E.; Martynov, I. Y.; Monyakina, L. A.; Nikol'skaya, I. V. *Inorganic Materials* **1997**, *33*, 579.
- Berger, D.; Maire, J. *Mater. Sci. Eng.* **1977**, *31*, 335.
- Yoshida, A.; Hishiyama, Y.; Inagaki, M. *Carbon* **1991**, *29*, 1227.
- Kang, F. Y.; Leng, Y.; Zhang, T. Y. *Carbon* **1997**, *35*, 1089.
- Inagaki, M.; Wang, Z. D. *Carbon* **1992**, *30*, 869.
- Skaf, D. W.; Edwards, J. K. *Syn. Met.* **1992**, *46*, 137.
- Bourelle, E.; Douglade, J.; Metrot, A. *Mol. Cryst. Liq. Cryst.* **1994**, *244*, 227.
- Inagaki, M.; Muramatsu, K.; Maekawa, K.; Tanabe, Y. *Tanso* **1985**, *123*, 160.
- Inagaki, M.; Shiwachi, Y.; Maeda, Y. *J. Chem. Phys.* **1984**, *84*, 847.
- Tanaike, O.; Inagaki, M. *Carbon* **1997**, *37*, 1760.
- Shen, W. C.; Cao, N. Z.; Zhou, L.; Kang, F. Y.; Gu, J. L. *Liquid-Phase Adsorption Performance on Expanded Graphite*. International Symposium of Carbon, 1998; p 384.