

# A Photosensitive Glass Chip for DNA Purification of Nucleic Acid Probe Assay

Joon-Ho Kim, Byung-Gyun Kim, Jun-Bo Yoon, and Euisik Yoon

**Abstract**— A new DNA purification chip is proposed and fabricated for the sample preparation of Nucleic Acid (NA) probe assay. The proposed DNA purification chip is fabricated using photosensitive glass substrate and polydimethylsiloxane (PDMS) cover fixture. We have successfully captured and eluted the DNA using the fabricated photosensitive glass chip. The fabricated DNA purification chip showed a binding capacity of  $15\text{ng}/\text{cm}^2$  and a minimum extractable input concentration of  $100\text{copies}/200\mu\text{L}$ . The proposed DNA purification chip can be applied for low-cost, disposable sample preparation of NA probe assays.

**Index Terms** — photosensitive glass, DNA, purification, sample preparation, bio-MEMS

## I. INTRODUCTION

Nucleic acid (NA) probe assays have enormous scope of applications in biotechnology and medicine, ranging from agriculture and farming to the detection of pathogens in foods to genetic diagnostics on human subjects [1,2]. Recently, much interest has been drawn to the implementation of microfluidic devices for NA probe assays. These devices are excellent candidates for miniaturization because the performance and costs of NA probe assays can be improved in the microscale and the microfabricated part can be used for many different assays by changing the natures of its reagents, and not the construction of the devices [3].

The purpose of NA probe assays is the detection and reporting of very small amounts of predetermined NA sequences in biological fluid samples [4]. As shown in Fig. 1, the process of NA probe assay is composed of three steps: sample preparation, amplification and detection. The first step is extraction, purification, and concentration of DNA from the complex biological sample. In the second step, amplification of the predetermined target sequence is performed by PCR. The final step is the detection and reporting of the resulting DNA product. These procedures typically include PCR for amplifying the number of copies of DNA to a detectable level. The PCR technique requires a relatively pure DNA sample in aqueous solution, free of inhibitors, during the PCR process. Therefore, the extraction and purification of nucleic acids from biological samples are the critical steps that should be carefully handled in the NA assays [5]. Also, this series of complex chemical processes are the most difficult and time-consuming.

In this paper, we propose a new DNA purification chip to address the sample preparation process for NA probe assays. In the DNA purification chip, the DNA's in the solution will bind to the exposed  $\text{SiO}_2$  surface at a high concentration of chaotropic salt [6]. Photosensitive glass has been chosen as a binding substrate because its process is simple and inexpensive compare to other alternative technologies such as silicon deep RIE technique [7].

## II. DESIGN AND FABRICATION PROCESS

### A. DNA Purification Chip on Photosensitive Glass Substrate

In general, it is known that DNA binds to silica in the high concentration of chaotropic salt (such as guanidine hydrochloride, sodium iodide) and elutes in low salt

---

Manuscript received August 12, 2001; revised September 7, 2001.

Department of Electrical Engineering and Computer Science (Division of E.E), Korea Advanced Institute of Science and Technology (KAIST) 373-1, Guseong-dong, Yuseong-gu, Daejeon, 305-701, Republic of Korea (e-mail :mythos@iml.kaist.ac.kr) Tel : +82-42-869-5462

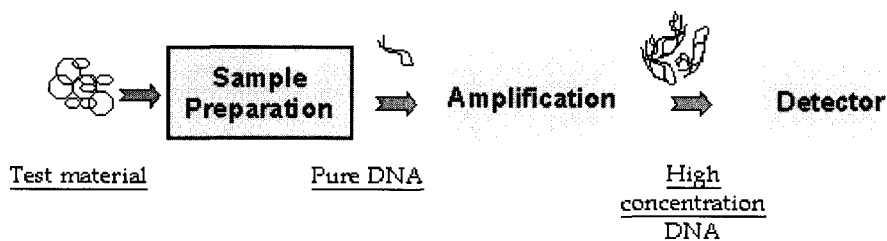

Fig.1. Typical process steps of Nucleic Acid probe assay

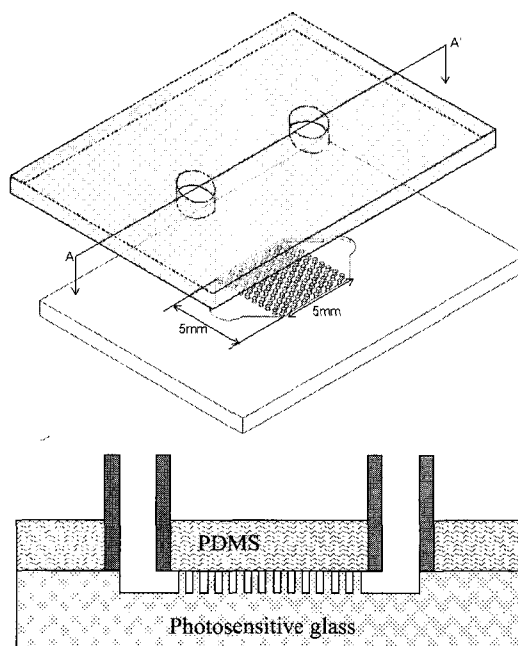

Fig. 2. Schematic diagram of DNA purification chip using photosensitive glass and PDMS.

[8,9]. The mechanism of DNA binding to SiO<sub>2</sub> surface in high salt may involve chaotropic salt disruption of the water structure around SiO<sub>2</sub> surface and DNA (OH terminated SiO<sub>2</sub> surface). In the high chaotropic salts, cations reduce the amount of free water available to solvate the DNA. As a result, SiO<sub>2</sub> surface and DNA dehydration effects and intermolecular hydrogen bond formation drive DNA adsorption to the SiO<sub>2</sub> surface. When the salt is removed, rehydration of the SiO<sub>2</sub> surface breaks the attraction between the SiO<sub>2</sub> surface and DNA. This characteristic is useful in that it can be used in the purification process. Since the DNA is eluted with either water or a low salt buffer, the elution process can be immediately followed in a subsequent reaction on the same substrate posterior to the binding procedure.

The proposed DNA purification chip has been designed in order to maximize DNA binding surface area on a photosensitive glass substrate, as shown Fig. 2. Photosensitive

glass has been chosen as a binding substrate because its process is simple and inexpensive compared with other alternative technologies such as silicon deep RIE [10-12].

DNA purification starts with the introduction of biological fluids into the microchannel of the fabricated chip. The biological fluids are mixed with an appropriate binding chemistry such as chaotropic salt; As a result, DNA naturally binds to the glass (SiO<sub>2</sub>) surface. A flow of the biological fluid sample through the multiple microchannels will result in a gradual accumulation of NA on the large surface area. After DNA has been adequately extracted in the binding process, wash solutions flow through the microchannel of the chip to wash away the remaining sample fluid. Finally, the DNA can be eluted from the chip by flowing through appropriate chemical buffer solutions.

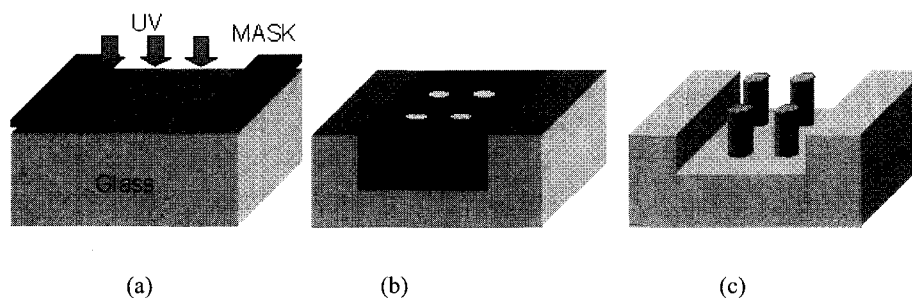

**Fig.3.** Fabrication processes of micro fluidic channels on photosensitive glass: (a) UV exposure at 310nm, (b) Crystallization, and (c) anisotropic etching 10:1 HF solution.

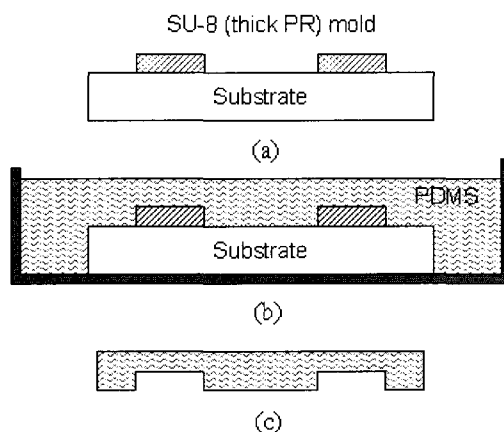

**Fig. 4.** Process flow of PDMS cover plate: (a) SU-8 mold patterning, (b) Curing PDMS, and (c) Peeling off.

**Table 1.** Heat treatment conditions of photosensitive glass

1'st Ramp Rate	Room Temperature $\rightarrow$ 500°C: 3°C/min
1'st Dwell Time	500°C, 1 Hour
2'nd Ramp Rate	500 °C $\rightarrow$ 600 °C : 1 °C/min
2'nd Dwell Time	600°C, 1 Hour
Cooling Time	500°C $\rightarrow$ Room Temperature: 3°C/min

### B. Fabrication Process

Fig. 3 shows the fabrication process flow of photo-sensitive glass. The first process step is exposing the substrates to an UV-light at about 300nm in wavelength. It is illuminated with an energy density of  $2.5J/cm^2$  and at the intensity of  $15mW/cm^2$ . Heat treatment is performed after exposure. Heat treatment condition is listed in Table 1. During this heat cycle, the exposed area will be crystallized and can be selectively dissolved in a solution of 10% hydrofluoric acid (HF) in an ultrasonic bath at room temperature. The etching rate of the exposed glass is about  $10\mu m/min$ . After the etching

process, the glass substrate is bonded to a PDMS cover plate to build closed channels.

The cover plate has been fabricated using PDMS, as shown in Fig. 4. The master for channel mold has been patterned on silicon wafer by using the SU-8. Next, the PDMS prepolymer mixture (curing agent: PDMS prepolymer=1:10) is poured onto the master. After curing for 90min at 85 °C, the PDMS replicas are peeled off from the master. And then, Oxygen plasma treatment for PDMS surface activation is performed for 10sec at 700mTorr and 100W RF power. Finally, plasma-treated PDMS cover plate is immediately bonded with surface of the fabricated photosensitive glass substrate and cured

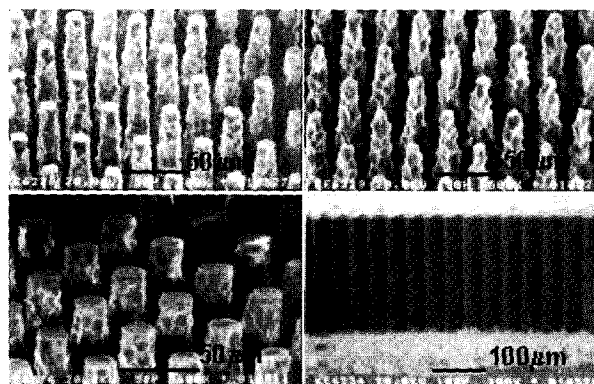

Fig.5. SEM pictures of the fabricated photosensitive glass microstructures.

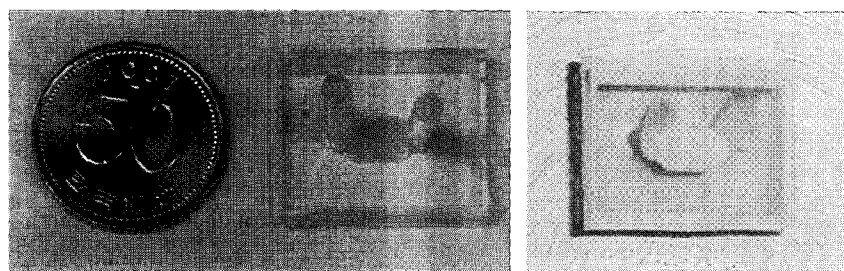

Fig. 6. Photographs of the fabricated DNA purification chip: (a) top view and (b) bottom view.

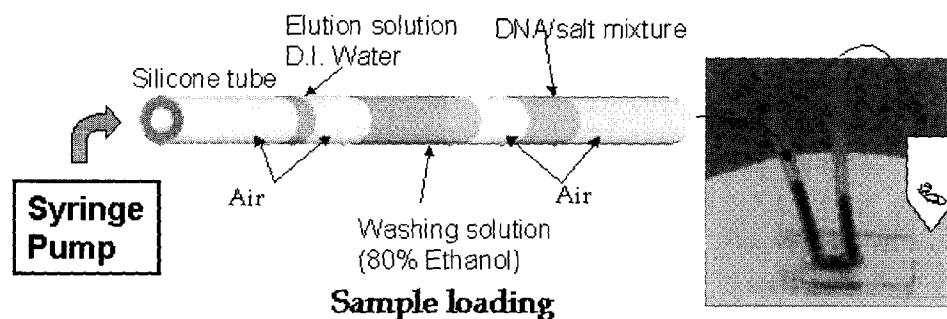
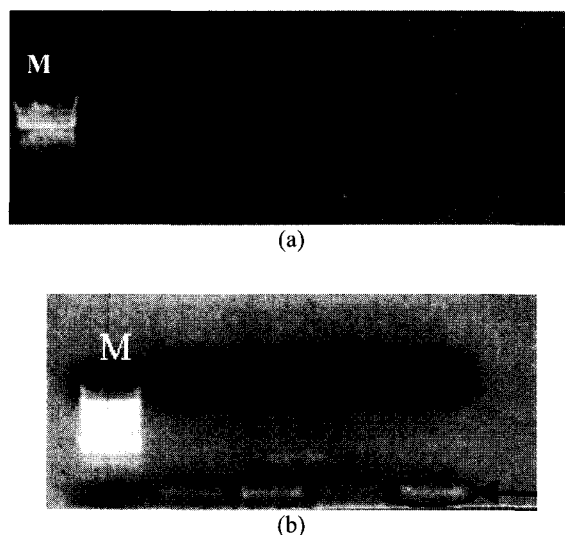

Fig. 7. Test bench of DNA purification chip.

Table 2. Conditions of test reagents.

Reagent	High concentration	Low concentration
Starting DNA	4780 basepair plasmid ds DNA	
DNA/chaotropic salt mixture volume	600ng/200µl	100copies/200µl
Chaotropic salt concentration	4.8mol/L guanidine HCl	5.8mol/L guanidine HCl
Wash solution	400µl ethanol	
Elution solution	40µl D.I. Water	
PCR	No	30cycles



**Fig.8.** Photograph of electrophoretic gel analysis results showing the eluted DNA from the DNA purification chip where the lane M denotes the marker: (a) high concentration sample ( $600\text{ng}/200\mu\text{l}$ ) without PCR and (b) low concentration sample ( $2\text{pg}/200\mu\text{l}$ ) with PCR amplification.

for 80min at  $85^\circ\text{C}$  on the hot plate.

### III. RESULTS AND DISCUSSIONS

Fig. 5 shows the fabricated photosensitive glass substrate that will form multiple microchannels. The fabricated glass surface consists of a number of pillars with a height of  $200\mu\text{m}$ . The diameter of the pillar is  $25\mu\text{m}$  and its pitch is  $50\mu\text{m}$ . The fabricated DNA purification chip is shown in Fig. 6. The chip has a total internal surface area of  $2\text{cm}^2$  that will be effectively used as DNA binding sites.

For the DNA binding test studies of the fabricated chip, a fluidic test system consisting of a microsyringe pump and several tubes have been used. An experimental protocol is as follows, as shown in Fig. 7. The conditions of used reagents are listed in Table 2. The chaotropic DNA starting solution is first passed through the chip. During this procedure, the DNA present in the solution binds to the glass surface of the microchannels. Next, the ethanol-based wash solution is introduced. The wash solution is intended to wash away the salts and other PCR inhibitors that might be present in the sample. Finally, an elution reagent is introduced to the chip and is kept for several minutes, after which the DNA is released back into the fluid stream. This solution is processed through gel electrophoresis with 1% agarose gels and ethidium bromide (EtBr) staining.

We have conducted two experiments. One is a high concentration sample ( $600\text{ng}/200\mu\text{L}$ ) and the other is a low concentration sample ( $100\text{copies}/200\mu\text{L}$ ). For the high concentration sample, the presence of the target DNA can be detected without PCR. Fig. 8 (a) shows the photograph of electrophoretic gel showing that the actual amount of DNA was successfully extracted from the fabricated DNA purification chip. The amount of the released DNA was detected about 30ng. From this, the binding capacity of the chip is estimated as  $15\text{ng}/\text{cm}^2$ . For the low concentration sample, PCR was performed to amplify a target sequence in order to detect the presence of the target DNA. Fig. 8 (b) shows that the fabricated purification chip can detect the gel band of the eluted DNA from a low concentration sample which is below  $100\text{copies}/200\mu\text{L}$  (or  $2\text{pg}/200\mu\text{L}$ ). These characteristics demonstrate that the proposed DNA purification chip can be used for the DNA purification in genomic diagnostic applications and the infectious disease diagnostic applications.

### IV. CONCLUSIONS

In this paper, we propose and have successfully fabricated the DNA purification chip for the sample preparation of Nucleic Acid probe assay. The proposed DNA purification chip was fabricated using photosensitive glass substrate and PDMS cover fixture. We have

successfully captured and eluted the DNA using the fabricated DNA purification chip that has a binding capacity of  $15\text{ng}/\text{cm}^2$  and a minimum extractable input concentration of  $100\text{copies}/200\mu\text{L}$ . These characteristics have demonstrated that the proposed DNA purification chip can be applied for low-cost and disposable microsystems for the sample preparation of nucleic acid probe assays.

### ACKNOWLEDGMENTS

This work was supported in part by the Korea Science and Engineering Foundation through the MICROS center at KAIST and National Research Laboratory program from Ministry of Science and Technology of Korea. The authors would like to thank Hyukjun Nam and Jichang You at Catholic University of Korea for their technical supports in electrophoretic gel analysis.

### REFERENCES

- [1] J. Buitkamp and J. T. Epplen, "Modern genome research and DNA diagnostics in domestic animals in the light of classical breeding techniques," *Electrophoresis*, vol. 17, pp. 1-11, 1996.
- [2] H. C. Hoch, L. W. Jelinski and H. G. Craighead, "Nanofabrication and biosystems," New York, Cambridge University Press, 1996.
- [3] C. H. Mastrangelo, M. A. Burns and D. T. Burke, "Microfabricated Devices for Genetic Diagnostics," *Proc. of The IEEE*, vol. 86, No. 8, pp. 1769-1787, 1998.
- [4] L. A. Christel, K. Petersen, W. Mcmillan, M. A. Northrup, "Rapid, Automated Nucleic Acid Probe Assays Using Silicon Microstructures for Nucleic Acid Concentration," *Journal of Biomechanical Engineering*, vol. 121, pp. 22-27, Feb. 1999.
- [5] A. Manz, H. Becker, "Microsystem technology in chemistry and life science," Berlin: Springer-Verlag, 1998.
- [6] W. R. Boom, H. M. A. Adriaanse, T. Kievits, T. Hague, P. F. Lens, "Process for isolating nucleic acid," *US patent* No. 5,234,809, 1993.
- [7] P. Belgrader, R. Joshi, J. Ching, S. Zaner, D. A. Brokholer, and M. A. Northrup, "Real-time PCR analysis on Nucleic acids purified from plasma using silicon chip," *Proc.  $\mu\text{TAS}2000$* , Netherlands, pp.525-528, 2000.
- [8] K. A. Melzak, C. S. Sherwood, R. F. B. Turner and C. A. Haynes, "Driving forces for DNA adsorption to silica in perchlorate solutions," *Journal of Colloid and Interface Science*, Vol. 181, pp. 635-644, 1996.
- [9] R. Lakshmi, V. Baskar, U. Ranga, "Extraction of Superior-Quality Plasmid DNA by a Combination of Modified Alkaline Lysis and Silica Matrix," *Analytical Biochemistry*, vol.271, pp. 109-112, 1999
- [10] Y.-R. Cho, J-Y. Oh, H.-S. Kim, and H.-S. Jeong, "Micro-etching technology of high aspect ratio frameworks for electronic devices," *Material science and Engineering*, vol. B, No. 64, pp.79-83, 1999.
- [11] K. Feindt, A. Harnisch, V. Zopping, D. Hulsenberg, and E. Kallenbach, "3-D Structuring of Photosensitive glasses," *Proc. MEMS'98 confrence*, Heidelberg, Germany, pp.207-210, 1998
- [12] <http://www.mikroglas.com>

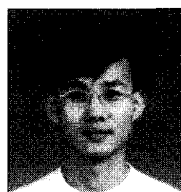

**Joon-Ho Kim** received his BS and MS degrees in Electrical Engineering from Korea Advanced Institute of Science and Technology (KAIST), Taejon, Korea, in 1992 and 1995, respectively. He is currently a Ph.D. candidate at the Korea Advanced Institute of Science and Technology (KAIST), Taejon, Korea. His current research interests are bio-MEMS, biosensors, uTAS and microfluidic systems.



**Byoung-Gyun Kim** received his BS degree in Electrical Engineering from Pusan National University, Pusan, Korea, in 1997, and MS degree in Electrical Engineering from Korea Advanced Institute of Science and Technology (KAIST), Taejon, Korea, in 2000. He is currently a Ph.D. candidate at the Korea Advanced Institute of Science and Technology (KAIST), Taejon, Korea. His current research interests are bio-MEMS, biosensors, uTAS and microfluidic systems.

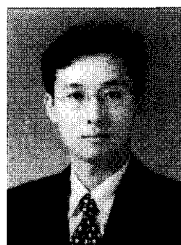

**Jun-Bo Yoon** was born in Seoul, Korea, in 1971. He received his B.S. (*Summa Cum Laude*), M.S., and Ph.D. degrees all in Electrical Engineering from Korea Advanced Institute of Science and Technology (KAIST), Taejon, Korea, in 1993, 1995, and 1999, respectively. His doctoral research involved in the development of the three-dimensional microstructure technology for microfluidic systems and integrated inductors. From 1999 to 2000, he was a postdoctoral research fellow at the University of Michigan, Ann Arbor, where he successfully developed a tunable micromechanical capacitor featuring

movable dielectric for RF applications. In 2000, he joined the Department of Electrical Engineering at KAIST, Taejon, Korea, where he is currently a research assistant professor. He has been involved in the development of single-crystal-silicon transmissive AMLCD using bulk micromachining, a monolithic thermal inkjet printhead, a surface-micromachined microgyroscope, and micromachined integrated inductors. His research interests include three-dimensional microstructure technology, MEMS process development, RF MEMS, and microfluidic systems. Dr. Yoon is currently a member of the IEEE, and has received the third-place award at the IEEE MTT-S International Microwave Symposium Student Paper Competition in 1999.

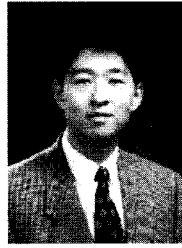

*Euisik Yoon* received his BS and MS degrees in Electronics Engineering from Seoul National University in 1982 and 1984, respectively, and Ph.D. degree in Electrical Engineering from the University of Michigan, Ann Arbor, in 1990. From 1990 to 1994, he was with the Fairchild Research Center of the

National Semiconductor Corp., Santa Clara, CA, where he was engaged in researches on deep submicron CMOS integration and advanced gate dielectrics. From 1994 to 1996, he was a Member of Technical Staff at Silicon Graphics Inc., Mountain View, CA, working on the design of the MIPS microprocessor R4300I and the RCP3-D graphic coprocessor. In 1996, he joined the Department of Electrical Engineering at Korea Advanced Institute of Science and Technology (KAIST), Taejon, Korea, where he is currently an associate professor. His current research interests include in MEMS, integrated microsystems, and VLSI circuit design.