

## **Development of Liquid Stub and Phase Shifter**

**Son Jong Wang**

Soong Sil University

Seoul, 156-743, Korea

sjwang@physics.soongsil.ac.kr

**Jae Sung Yoon and Bong Guen Hong**

Korea Atomic Energy Research Institute

150 Dukjin-dong, Yusong-gu, Taejon 305-353, Korea

(Received September 14, 2000)

### **Abstract**

The high power RF transmission line components are required for transmitting MW level RF power continuously in RF heating and current drive system which heat the plasma and produce plasma current in fusion reactor. The liquid stub and phase shifter is proposed as the superior to the conventional stub and phase shifter. Experimental results show that they are reliable and easy to operate compared to the conventional stub and phase shifter. There is no distortion of reflected power during the raising of the liquid level. RF breakdown voltage is over 40kV. Temperature increment of the liquid is expected not to be severe. These results verify that the liquid stub and phase shifter can be used reliably in the high power continuous RF facilities.

**Key Words** : ICRF heating, KSTAR, liquid stub, liquid phase shifter, tuning, transmission line

### **1. Introduction**

The design of the KSTAR(Korean Superconducting Tokamak Advanced Research) tokamak is being constructed to do long-pulse, high- $\beta$ , advanced tokamak fusion physics experiments[1]. The ICRF(Ion Cyclotron Range of Frequency) system will deliver 6MW of RF power to the plasma in the 25 to 60MHz frequency range, using a single four-strap antenna mounted in a midplane port. It will be used for ion heating, FWCD(Fast-Wave Current Drive), and MCCD(Mode-Conversion Current Drive)[2,3]. The

ICRF system will be capable of 300sec operation with 12MW(upgrade) of RF power to the plasma. High power RF transmission line components are the major part of the system. Key performance required is the maximum voltage and current without breakdown[4,5].

Conventional stub and phase shifter have some problems such as fabricating straight coaxial lines, local temperature increase and insulation breakdown[4,6] when operating for long pulse under high power. To solve problems in conventional stub and phase shifter, innovative research and development has been performed by

using liquid instead of gas for insulating dielectric material.

Electric effects of changing mechanical length of transmission line are the same to those of changing dielectric constant  $\epsilon$  of the medium or changing the portion of one dielectric material to the other. Liquid stub tuner uses liquid of dielectric constant  $\epsilon_0$  at some portion of transmission line and insulating gas of vacuum dielectric constant  $\epsilon_0$  at the remaining portion. Let  $A_L$  is a normalized length of the liquid section located at the shorted side and  $A_G$  is a normalized length of remaining gas section. Normalized length is defined by  $A=fl/\beta$  where  $f$  is operating frequency,  $l$  is mechanical line length and  $\beta$  is phase speed in the medium. Characteristic impedance ratio of liquid to the vacuum transmission line is  $Z_{0L}/Z_{0G} = 1/\epsilon^{1/2}$ . If the conventional stub tuner shunted at the input of the load is compared to the liquid stub located at the same position, following equation is hold true for the same electrical effect[7].

$$\frac{1}{\tan 2\pi A} = \frac{1 - \frac{Z_{0L}}{Z_{0G}} \tan 2\pi A_G \tan 2\pi A_L}{\tan 2\pi A_G + \frac{Z_{0L}}{Z_{0G}} \tan 2\pi A_L} \quad (1)$$

Liquid stub configured to have  $A_L$  and  $A_G$  as the portion of liquid and gas results in the same

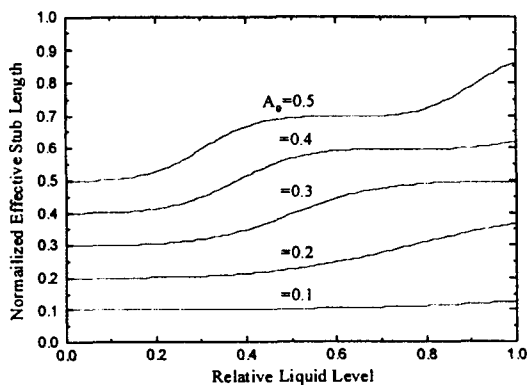

Fig. 1. Electrical Length of Liquid Stub with the Various Stub Length

electrical effects with the conventional stub having length  $A$ . So  $A$  in the equation (1) can be called normalized effective stub length. Fig. 1 shows calculated result of equation (1) for five different lengths of liquid stubs.  $A_0$  is the mechanical stub length normalized to the vacuum wavelength. Normalized effective stub length  $A$  increases with the liquid level. Dielectric constant is chosen to be  $\epsilon=2.72$ . Large  $A_0$  makes length variation large but there are unnecessary flat region when  $A_0$  is larger than 0.4. To make large length variation but mechanically small stub tuner,  $A_0=0.3$  should be chosen.

The liquid phase shifter is similar to the liquid shorted stub. It uses liquid dielectric material as wave propagation medium at some portion of the transmission line. The difference is that it has two symmetrical ports instead of one shorted end in the stub. Phase shift between the two ports can be varied by changing the ratio of the length of the liquid section to the total length and is roughly proportional to the ratio if the load is matched. The liquid phase shifter has no advantage when it is inserted at the matched line. Since the liquid phase shifter uses different characteristic impedance of transmission line there are always two discrete boundaries having reflection ratio

$$\rho = \frac{Z_{0G} - Z_{0L}}{Z_{0G} + Z_{0L}} \quad (2)$$

If the liquid of dielectric constant  $\epsilon=2.72$  used, reflection ratio becomes  $\rho \sim 0.25$  which is not acceptable. But advantages are the same to the liquid stub when the liquid phase shifter is inserted at the unmatched line, i.e. used as a part of tuner.

## 2. Fabrication of the Liquid Stub and the Liquid Phase Shifter

Silicon oil (Dimethyl Polysiloxane) is used as the dielectric liquid medium. Characteristic of the

**Table 1. Characteristics of Silicon Oil (Dimethyl Polysiloxane)**

Specific Gravity (25°C)	0.960
Viscosity (25°C)	50mm <sup>2</sup> /s
Vapor Pressure (<260°C)	<0.1mmHg
Specific Heat (25°C)	0.36cal/g · °C
Thermal Conductivity (25°C)	3.7 × 10 <sup>-4</sup> cal/cm · sec · °C
Resistivity*	>1 × 10 <sup>14</sup> Ω · cm
Dielectric Strength*	>50kV/2.5mm
Dielectric Constant (50Hz)*	2.72
Dielectric Loss (tanδ)*	<0.0001

\*-Water <50ppm

silicon oil is listed in Table 1. The dielectric constant,  $\epsilon$  is 2.72 and dielectric loss tangent,  $\tan\delta$  is  $10^{-4}$  in the low frequency at 25°C. Vapor pressure is known to be less than 0.1mmHg below 25°C. Low dielectric loss and vapor pressure are the reason of the choice. Dielectric loss tangent of the liquid is small, but is not ignorable when the RF power is fed continuously. If RF voltage  $V_{RF}$  is applied to the coaxial transmission line having radius  $a$  and  $b$  for the inner and outer conductors, electric field  $E(r, z)$  is as following;

$$E(r, z) = \frac{V_{RF}}{\ln(b/a)} \frac{1}{r} \sin\left(\frac{2\pi}{\lambda_L} z\right) \quad (3)$$

RF dielectric power loss,  $P_L$  is an integration of electric field in equation (3).

$$P_L = \frac{1}{2} \epsilon \epsilon_0 \tan \delta \omega \int_0^z \int_a^b 2\pi E^2(r, z) r dr dz$$

$$= \pi \epsilon \epsilon_0 \tan \delta \omega \frac{V_{RF}^2}{\ln(b/a)} \left[ \frac{1}{2} z - \frac{\lambda_L}{8\pi} \sin\left(\frac{4\pi}{\lambda_L} z\right) \right] \quad (4)$$

where  $\lambda_L$  is RF wavelength in the dielectric medium. If we assume that the surface of liquid is at  $1/4$  wavelength position  $P_L$  becomes.

$$P_L = \frac{\pi}{8} \lambda_L \epsilon \epsilon_0 \tan \delta \omega \frac{V_{RF}^2}{\ln(b/a)} \quad (5)$$

When  $10^4 \tan\delta = 2$ ,  $\omega = 2\pi \times 30(\text{MHz})$ ,  $\ln(b/a) = 0.835$ ,  $\epsilon = 2.72$ , assuming thermally

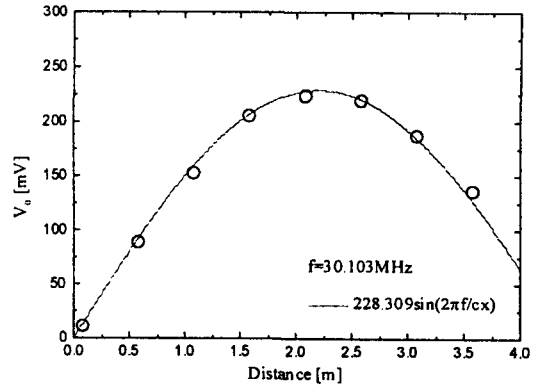

**Fig. 2. Comparing Voltage Probe Output Signals with the Calculated Voltage Along the Stub Without Liquid. Open Circles are Measured Voltages**

insulated system with heat capacity of liquid 0.36cal/g · °C and 5min continuous power, temperature increment  $\Delta T$  is

$$\Delta T \approx 0.01 V_{RF}^2, V_{RF} \text{ in } kV. \quad (6)$$

When voltage  $V_{RF}$  is 35kV which is the maximum allowing voltage of the KSTAR ICRF system[2],  $\Delta T$  is in the acceptable range of 13°C.

4m long stub is fabricated using 6-1/8" nominal diameter copper transmission line. One end is electrically shorted and mechanically closed. The other end has flange to meet T-junction. Between two ends, 3m apart from the shorted end, separating disk made by Teflon is inserted to stop the diffusion of vaporized oil to the other part of transmission line. The stub is installed vertically so that the portion of the liquid is maintained by the gravity. Liquid inlet-outlet is located at the bottom, shorted end. Eight capacitive voltage probes and two thermocouples are arranged through the holes on the outer conductor.

Voltage probe is made of simple capacitive coupling tip and termination resistor. The output voltage  $V_0$  is scaled by

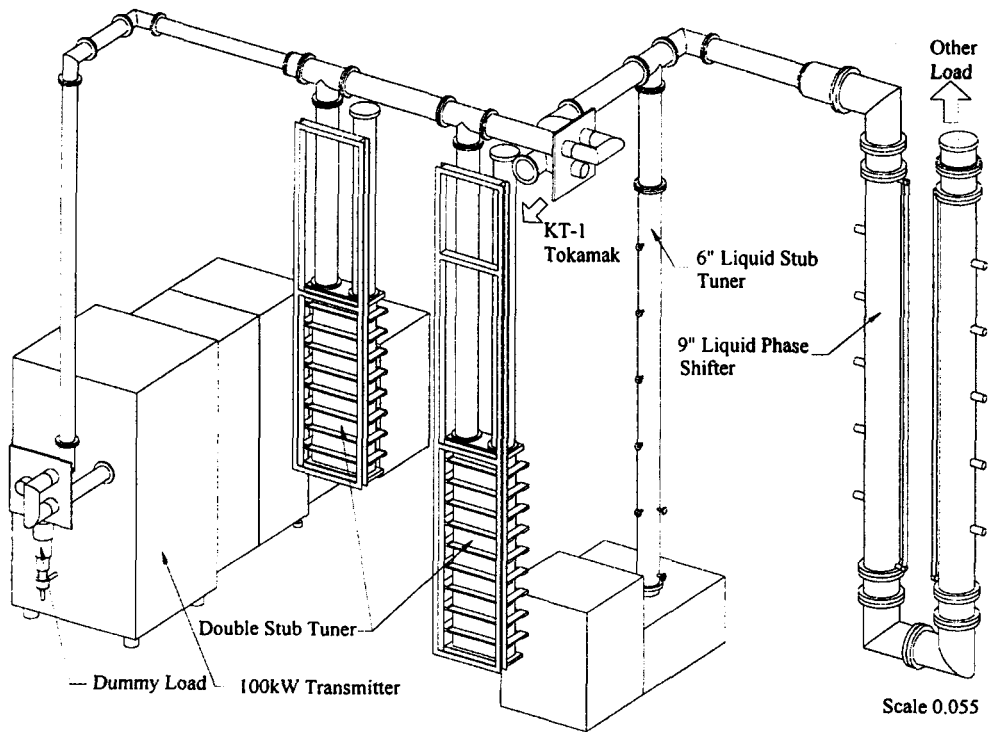

Fig. 3. The Overall View of the RF Test Facility

$$V_0 = -j\omega CRV \quad (7)$$

where  $\omega$  is operating angular frequency,  $C$  is coupling capacitance,  $R$  is termination resistance and  $V$  is voltage to be measured. Calibration is done with applying low RF power to the stub without liquid and measuring probe output voltage. Comparing the signal by applying the calculated voltage is shown in Fig. 2. Open circles are measured voltages and the solid line is calculated voltage distribution. When the liquid is supplied, coupling capacitance will be increased proportionally to the dielectric constant, and according to equation (7), coupled voltage is known.

The liquid phase shifter is made of 9-3/16" nominal diameter aluminum transmission line. Two identical 3m long liquid phase shifter is

connected with U shaped 1.6m spacing elbow shown in Fig. 3. By the configuration, the position of the liquid phase shifter as well as liquid level can be varied. At the bottom of each phase shifter, there are Teflon disks which separate the liquid in phase shifter section and the gas in elbow section. Other diagnostic tools and liquid supplying systems are the same as those of the liquid stub.

The overall view of the RF test facility is shown in Fig. 3. Control cables, oil and gas lines, supporting structures are omitted for simplicity. 100kW power transmitter with two intermediate driving stages is capable of producing 28-32MHz RF power continuously. Almost any load impedance, virtually from shorted to open, can be matched to the transmitter output impedance through conventional double stub tuner. Some limitations of the double stub tuner are frequent,

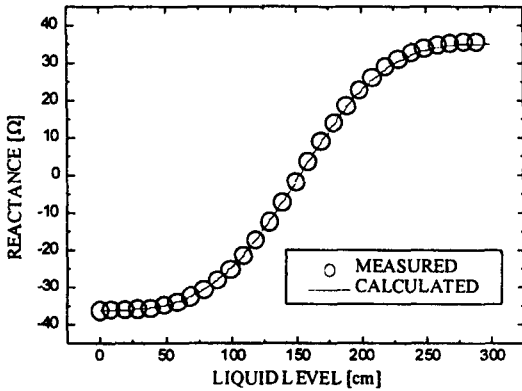

Fig. 4. Variation of Shorted Liquid Stub Reactance v.s. Liquid Level

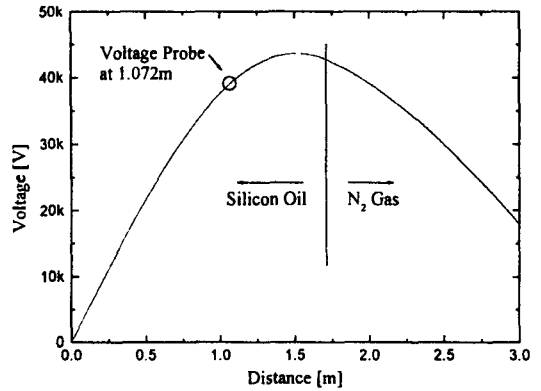

Fig. 6. Measured Voltage Distribution Along the Stub with High Power

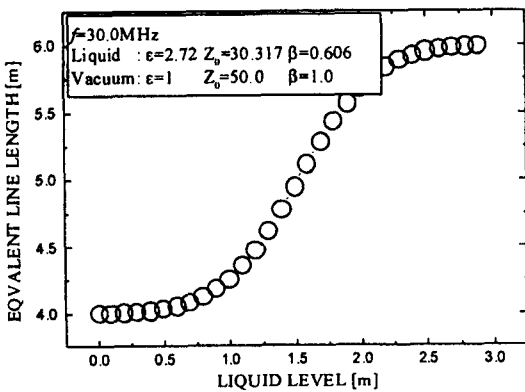

Fig. 5. Equivalent Line Length v. s. Liquid Level

random breakdown at the voltage larger than 30kV and gradual degradation of the finger stocks. The later limitation causes expecting of tuning position hard and sometimes, unexpectedly, unable tuning at particular load impedance.

Liquid stub tuner and liquid phase shifter under developing are shown at the right hand side of Fig. 3. RF power is switched to either the test facility or KT-1 tokamak for ICRF study. The length of stub tuner is 4m from the shorted bottom end to the T-junction. Silicon oil can be supplied up to 3m and the flange for the separating disk mentioned previously is shown at this position.

The liquid phase shifter is installed in series to the other transmission line and its output is opened. For the test the other load, i.e. vacuum feedthrough or ICRF antenna under developing, the output port of the liquid phase shifter is connected to the load.

### 3. Experimental Results

Cold test results of the liquid stub are shown in Fig. 4 and Fig. 5. As liquid level is raised, input reactance of the stub varies from -35  $\Omega$  to 35  $\Omega$  while equivalent line length varies 2m. Equivalent line length is defined as normalized effective stub length in equation (1) multiplied by the vacuum wavelength, i.e. electrical length of the stub at the given frequency. All the results agree exactly with the calculated values.

One notable qualitative result is that there is no distortion of the reflected RF power during liquid level raised when the low power, 0dBm, is supplied to the stub. Even a carefully designed finger stock type stub shows severe distortion of the reflected power due to the imperfection of the finger stock. This result shows that the liquid stub can be used to match time varying load without disconnect the RF power[8] if speed of liquid level

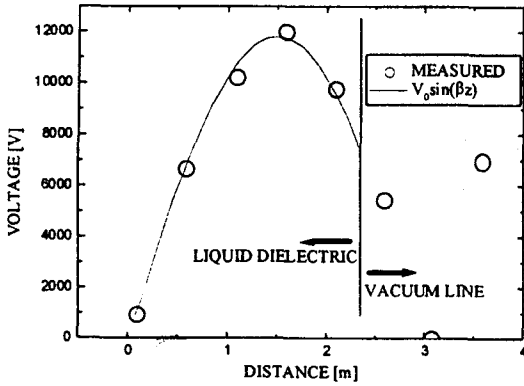

**Fig. 7. Voltage Distribution Along the Stub with Low Power**

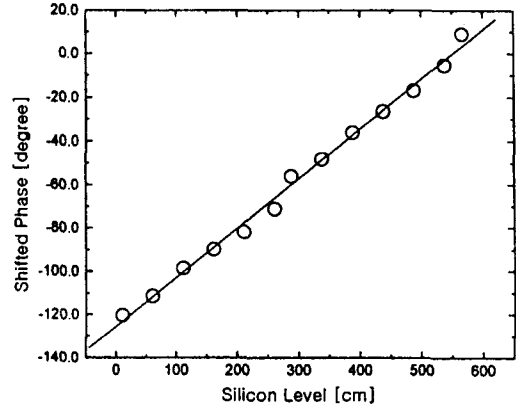

**Fig. 8. Phase Variation of the Liquid Phase Shifter**

variation is faster enough than the load variation speed[4]. Another advantage is that the physical volume of the liquid stub is smaller than the conventional stub. The liquid stub is 4m long and has 4-6m variation of electrical length at 30MHz. At least 6m long conventional stub is needed to have the same length variation.

Fig. 6 shows voltage distribution of the liquid stub. An open circle is the measured data point with the probe and the solid curve is the fitted result from the data point. The equation used to fit the data is an absolute value of the voltage distribution among the following voltage and current distribution formulae.

$$V = V_i \cos\left(\frac{2\pi}{\lambda} z\right) - iI_1 Z_0 \sin\left(\frac{2\pi}{\lambda} z\right) \quad (8)$$

$$I = I_1 \cos\left(\frac{2\pi}{\lambda} z\right) - i\frac{V_i}{Z_0} \sin\left(\frac{2\pi}{\lambda} z\right) \quad (9)$$

Where  $z$  is the distance from the boundary where  $V_i$  and  $I_1$  are known. These formulae are applied recursively at each transmission line segments with the shorted boundary condition. Fig. 7 is another voltage distribution of the liquid stub with the lower RF power than the previous one and eight voltage probes are used to measure

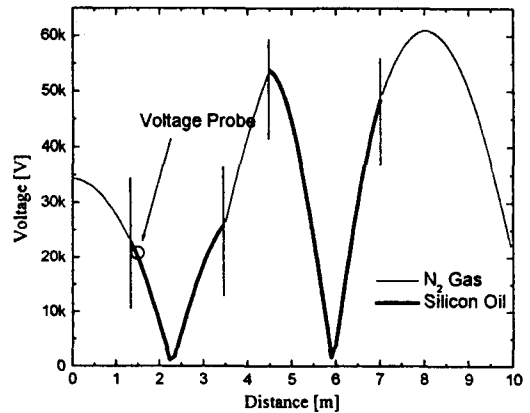

**Fig. 9. Voltage Distribution of the Liquid Phase Shifter**

voltage distribution. This verifies that the fitted curve with one probe data as in the Fig. 6 is a reasonable voltage distribution of the system. The highest voltage applied to the stub is ~44kV without electrical breakdown with the pulse width of 100msec. With the conventional stub tuner as a part of the RF test facility, the rated voltage is too high to maintain continuously.

Fig. 8 shows phase shifting effect of the phase shifter at 30MHz with low power. This test is done with matched load and as mentioned in section 1, variation of the phase is almost linear to that of

**Table 2. Experimental Results in the Liquid Stub and the Liquid Phase Shifter**

	Liquid Stub	Liquid Phase Shifter
Mechanical Length	4m	8.8m
Length Variation(30MHz)	2m	3.6m
Phase Variation(30MHz)	N/A	130°
Maximum Voltage(100msec)	44kV	53kV

the liquid level but not exactly proportional. High voltage applied to the liquid phase shifter is shown in Fig. 9. The distance is measured from opened end. The fitting procedure is the same as the case of liquid stub with the open boundary condition. Maximum voltage at the boundary of liquid and gas exceeds 50kV. As the case of the liquid stub, time duration of the RF power is 100msec.

Table 2 is the major experimental results of the liquid stub and phase shifter. Length and phase variations are exactly same as the design value and the maximum achieved voltages with 100msec pulse are exceeds 40kV and 50kV for the liquid stub and phase shifter respectively.

#### 4. Conclusions

The liquid stub and the phase shifter for the high power RF components were developed. It seems that they are reliable and easy to operate compared to the conventional stub and phase shifter. There is no distortion of reflected power during the liquid level is raised. As shown in Table 2 and remembering that the experiment limits come from conventional stub tuner, the breakdown voltage of the liquid stub and phase shifter is higher than that of the finger stock type stub or phase shifter. Temperature increment of the liquid is expected not to be severe but should be studied experimentally with continuous high power.

#### Acknowledgements

This work was supported by the Korean Ministry of Science and Technology and the Korean Research Foundation Grant No. 1999-015-DP0090.

#### Reference

1. G.S. Lee et al., "Present Status of Korean National Fusion Project based on Advanced Superconducting Tokamak, KSTAR", *Bull. Am. Phys. Soc.*, **41**, 1439 (1996).
2. B.G. Hong et al., "Physics and Engineering Aspects of the ICRF Heating and Current Drive System on KSTAR", 17<sup>th</sup> *IEEE/NPSS Symposium on Fusion Engineering*, Oct. 6 - 10, San Diego, Vol. 1, 469 (1998).
3. Y.D. Bae, C.K. Hwang, B.G. Hong, J.S. Yoon, and S.J. Wang, "Engineering Design of the ICH Antenna for KSTAR and Fabrication of the Prototype Antenna", *Sae Mulli*, **40**, No. 5, 446 (2000).
4. R. Kumazawa, T. Mutoh, T. Watari, F. Shinbo, G. Nomura, S. Masuda, T. Ido, and T. Kuroda, "Achievement of 1.6MW/5000sec Operation of Rf Oscillator on the Large Helical Device", *Proceedings of the 19th Symposium on Fusion Technology*, Vol. 1, 617 (1997).
5. B.G. Hong et al., "KSTAR ICRF System for Long Pulse Operation", 10<sup>th</sup> *International Toki conference*, Jan. 17 - 21, (2000).
6. S.W. Ferguson, R.W. Callis, W.P. Cary, D.A. Phelps, D. Ponce, F.W. Baity, and G. Barber, "RF High Voltage Performance of RF Transmission Line Components on the DIII-D Fase Wave Current Drive (FWCD) System", 16<sup>th</sup> *IEEE/NPSS Symposium on Fusion Engineering*, Oct. 1 - 5, Champaign, Vol 1, 837 (1995).

7. R. Kumazawa, T. Mutoh, T. Seki, F. Sinpo, G. Nomura, T. Ido, and T. Watari, "Liquid Stub Tuner for Ion Cyclotron Heating", *Rev. Sci. Instr.*, **70**, No.6, 2665 (1999).
8. S. Moriyama, H. Kimura, T. Fujii, T. Yamamoto, and M. Saigusa, "Real-time Impedance Matching by Frequency Feedback Control in Ion Cyclotron Range of Frequency Heating Experiments in JT-60U and Future Tokamaks", *Jpn. J. Appl. Phys.*, **37**, 6204 (1998).