

A Comparison of Efficiency of Decolorizing Rhodamine B using Lab-Scale Photocatalytic Reactors : Slurry Reactor, IWCR and PFBR

Young-Soo Na, Tae-Kyung Lee, Song-Woo Lee, Chang-Han Lee, Do-Han Kim, Young-Seek Park*, and Seung-Koo Song

Department of Chemical Engineering, Pusan National University
*Seobong Recycling Co, Ltd.

(Manuscript received on May 25, 2001)

The performance of fluidized-bed reactor with Photomedia, immobilized TiO₂ onto the porous ceramic ball using a sol-gel method has been studied in this work. A simple model substrate, dilute Rhodamine B (RhB), was decolorized at room temperature. For the purpose of comparison, the slurry reactor and the Inner Wall Coated Reactor (IWCR) were used. The aim of this work was to develop the photocatalytic fluidized bed reactor (PFBR) through contrasting the photodegradability of various reactors such as the TiO₂ slurry reactor, the inner-wall coated reactor (IWCR).

In this study, the RhB was decolorized in three types of reactor. Even though the reaction rate constant of PFBR was lower than that of slurry reactor, PFBR had the advantages of preventing the wash-out of photocatalyst, so it can be operated continuously.

Key words : TiO₂, photocatalyst, photomedia, photodegradation, the reaction rate constant

1. Introduction

Industrial development is widely connected with the disposal of a number of toxic pollutants that are harmful to the environment and human health. Such pollutants are also not degraded easily in nature. The photocatalytic treatment is one of the attractive alternatives¹⁻³⁾. The mechanisms of the photocatalytic oxidation of organic contaminants using a TiO₂ photocatalyst have been studied extensively. The mechanism of the photocatalytic process of the TiO₂/UV system can be explained by the band gap energy model^{4,5)}.

Photocatalytic degradations of organic compounds using aqueous semiconductor powder dispersions have been performed for many years. However, these results were not practically satisfactory. Thus using catalyst suspension in any wastewater treatment process may not be recommendable because micro filtration and resuspension should be avoided, if possible. In principle, photocatalysts can be employed to immobilize on a

suitable support material(e. g., quartzs sand⁶⁾, glass⁷⁾, silica gel⁸⁾, optical fiber^{9,10)}, ceramics¹¹⁾), operating in either fixed or fluidized bed configurations. From an engineering point of view a fluidized bed reactor is preferable, so as to avoid costly particle-fluid separation stage downstream.

Piscopo et al.¹²⁾ tried to make TiO₂ supported on a glass external surface and internal surface by sonication. Also, a recirculating system of aqueous trichloroethylene(TCE) solutions through a packed bed reactor with TiO₂ pellets has been developed in order to mineralize TCE without difficulties for filtration and recovery of the catalyst.¹³⁾ These results proved to be satisfactory and highly efficient, but there are difficulties in applying them to a fluidized bed reactor.

This study has made a photocatalytic media, named Photomedia, as the photocatalyst for the photocatalytic fluidized bed reactor(PFBR). The support of the photocatalytic media in the shape of a hollow ball was made of ceramic (main material : zeolite, density <1), and the balls surface was

coated with TiO₂-sol.

2. Materials and Methods

2.1. Materials

The dye used as the test pollutant in this experiment was Rhodamine B (RhB). The TiO₂ powder used was titanium dioxide (Junsei co., anatase). The Photomedia (Fig. 1) was prepared as the following procedure: The hollow ceramic ball (zeolite) was dipped into the colloidal solution (TiO₂ sol: Deiha-international Co.) and dried at room temperature in a dust-free environment for 24 hours before heat treatment, then it was calcinated at 500 °C in air for 2 hours. This work was repeated six times. The average diameter and the surface area of Photomedia were 1.5 mm and 7.07 mm² respectively.

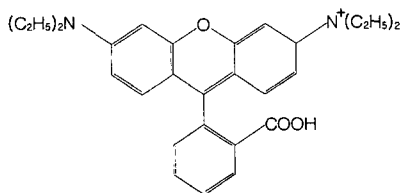

Fig. 1. The structure of RhB.

An analysis of the SEM/EDX results of Photomedia surfaces showed that the uncoated photomedia has Oxygen and Silicon on the surface along with a small amount of Potassium and calcium. However, the high percentage of Titanium found on the surface results from the coating materials for the SEM/EDX analysis (Table 1).

Table 1. Photomedia surface of atomic composition (%)

	Hollow ceramic ball	Photomedia
O	67.83	58.32
Si	24.04	11.61
Ti	0	30.07

2.2. Photoreactors

Three photocatalytic reactors were assembled for TiO₂ slurry reactor, IWCR and PFBR. The reactors are schematically illustrated in Fig. 2, 3, and 4 respectively. The TiO₂ slurry reactor consisted of

a cylindrical Pyrex vessel (diameter = 120 mm, height = 100 mm) and a port for an air sparger. A 20W UV lamp (Sankyo Denki) with an emission peak at 254 nm was installed in the upper position of the vessel. The slurry of RhB solution and the TiO₂ powder was mixed by a magnetic stirrer.

IWCR was a type of a cylindrical annular-type reactor. The body of the reactor was made of acrylic resin, and the TiO₂ powder was loaded on the surface of the inner wall by using a UV-resistant adhesive. The reaction volume was 700 mL, and the feed tank volume was 300 mL. The design specifications of PFBR were as follows. Four 20W UV lamps (Sankyo Denki) were installed inside of the reactor, so that the maintenance and repair of

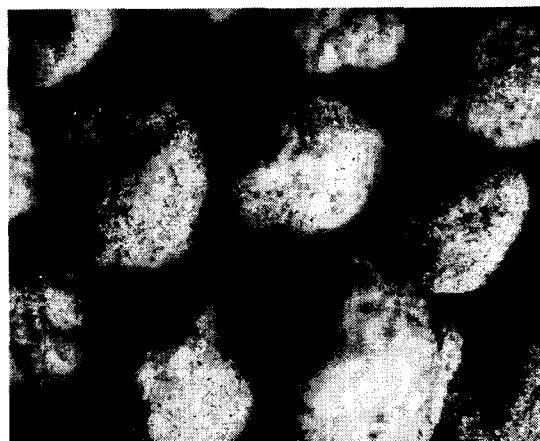

Fig. 2. The photograph of Photomedia.

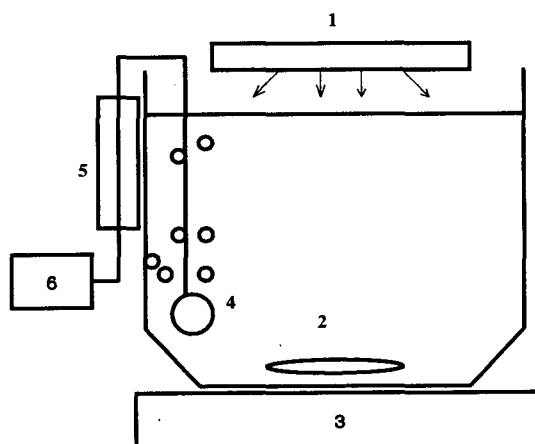

Fig. 3. The schematic diagram of a slurry reactor. 1. UV lamp, 2. magnetic bar, 3. stirrer, 4. air sparger, 5. rotameter, 6. air pump

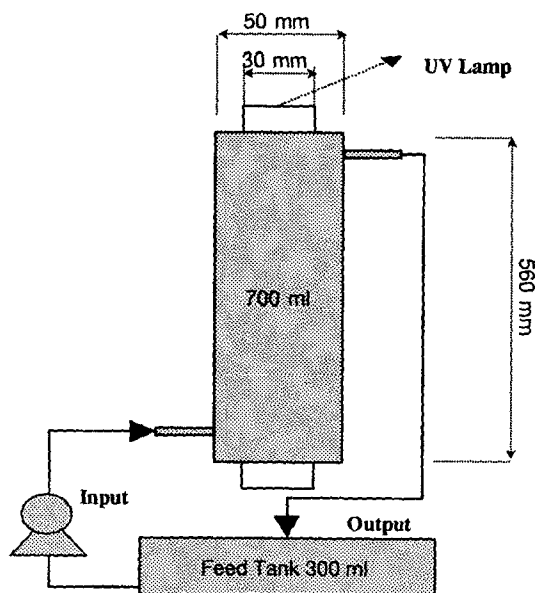

Fig. 4. The schematic diagram of the inner wall coated reactor(IWCR).

the reactor can be easily done. The vertical plate inside of the reactor and the air stream blowing from the bottom of the reactor at 1 L/min rate made it possible for the reactant to circulate well and mix perfectly. And raw water was fed into the top inlet and the treated water was discharged out of the bottom of the PFBR. A fluidized zone was 603 mm ~ 633 mm in height, and the reactor volume was 24 L. Photomedia in the reactor was fluidized well by air blowing from a sparger at the bottom of the reactor.

2.3. Procedures

In the TiO₂ slurry reactor, unless otherwise noted, TiO₂ suspension was prepared by adding 0.1g/L, 0.25g/L, and 1g/L of TiO₂ powder into 500 mL of 21 μM RhB solution. The air-flow rate was adjusted to 1L/min. The initial concentrations were 2.8 μM, 5.8 μM, 6.8 μM, and 11.2 μM in IWCR, and the input flow rates were 20 mL/min, 26 mL/min, 30 mL/min, and 36 mL/min when the initial concentration was fixed at 6.8 μM. For a batch experiment, 70g_{Photomedia}/L_{solution} and an RhB solution with 6 μM concentration were fed into PFBR and the PFBR was continuously operated for 20 days at 12 hours HRT.

2.4. Analysis of Data

The UV/VIS spectrophotometer(Lambda 20 : PERKIN ELMER) was used for optical absorption spectra on a RhB solution. The determination wavelength was 550 nm, which was the maximum absorption wavelength. To eliminate TiO₂ powder from the samples, the sample from the slurry reactor was treated using a centrifuge device at 2,500 rpm (1200 G) for 15 minutes. After the filtrate was obtained, the RhB concentration was measured using the calibration curve of the RhB concentration at 550 nm wavelength by a UV/VIS spectrophotometer. The RhB concentrations of the effluent from IWCR and PFBR were measured without any further treatment.

3. Results and Discussion

3.1. Slurry reactor

The characteristic peak of an aqueous RhB (0.01mM) solution decreased considerably with the addition of TiO₂ particles in the photocatalytic reaction(Fig. 5). Subsequent illumination for 3 hrs led to a continued diminution of absorption peaks of the RhB dye. It was shown that the chromophore of the RhB was destroyed. Thus we concluded that RhB could be decolorized in a photocatalytic system.

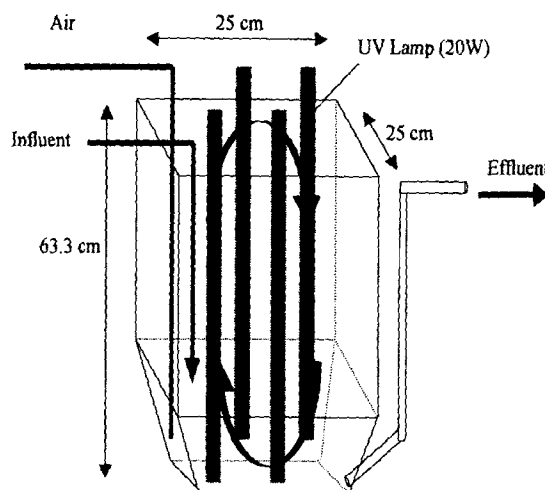

Fig. 5. The Schematic diagram of a Photocatalytic Fluidized Bed Reactor(PFBR Total volume : 40L, Reaction volume : 24L(60 %)).

The effects of TiO_2 with/without UV light on decolorization is illustrated in Fig. 6. To examine the photodegradability of TiO_2 in the RhB solution, four different experimental conditions were studied : in the dark without TiO_2 (control condition) ; in the dark in the presence of TiO_2 ; UV irradiation in absence of TiO_2 and UV irradiation in the presence of TiO_2 . During the experiment, the initial concentration of RhB was kept at $22 \mu\text{M}$, and the amount of TiO_2 was 0.1g/L .

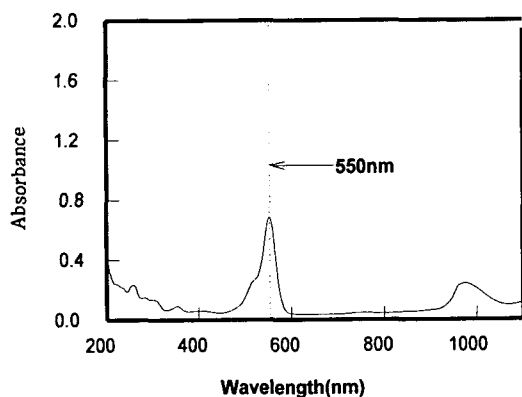

Fig. 6. The UV/VIS spectrum of Rhodamine B.

The reaction rate constant of each case was $0.006 \text{ E-}3 \text{ min}^{-1}$ at control test, $0.008 \text{ E-}3 \text{ min}^{-1}$ with TiO_2 , $0.717 \text{ E-}3 \text{ min}^{-1}$ with UV light, $18.45 \text{ E-}3 \text{ min}^{-1}$ with TiO_2 0.1g/L and UV light. The concentration of RhB with TiO_2 only or UV only decreased slightly but in the presence of both TiO_2 and UV light, more than 95 % of RhB was decolorized within 60 minutes. The reaction rate increased with increasing catalyst concentration, and the order of the reaction rate was $1 \text{ g/L}(34.90\text{E-}3 \text{ min}^{-1}) > 0.25\text{g/L}(24.99\text{E-}3 \text{ min}^{-1}) > 0.1\text{g/L}(18.45\text{E-}3 \text{ min}^{-1})$ (Fig. 7).

3.2. IWCR

The photocatalyst concentration plays a very important role in any process of water treatment, but it was impossible to change the photocatalyst concentration in case of IWCR because the amount of photocatalyst coated on inner surface of the reactor couldn't be changed.

The effect of the initial concentration of RhB and the flow rate of the influent were considered to compare the performance of IWCR with the

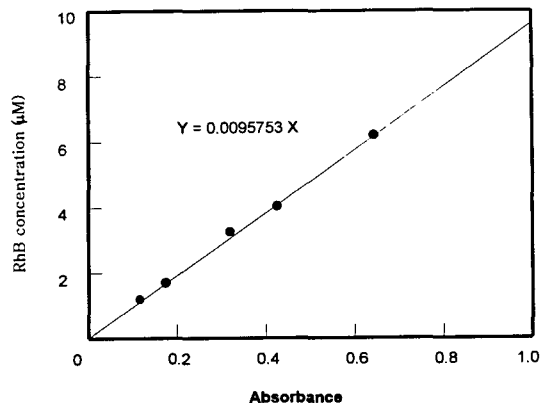

Fig. 7. The Calibration curve of Rhodamine B.

performance of PFBR at optimal conditions.

Fig. 8 shows the photodegradation of RhB with various concentrations in IWCR. All the concentration profiles could be correlated by the following exponential function(pseudo-first-order) with good agreement.

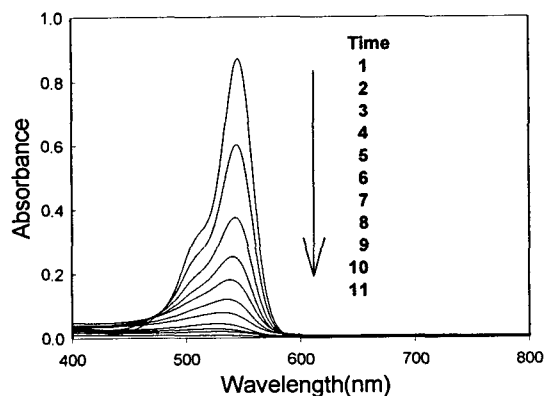

Fig. 8. The absorbance spectrum of an aqueous solution containing RhB(0.01 mM). (1) Spectrum taken before irradiation and after subsequent irradiation for (2) 0.3h, (3) 0.6h, (4) 1h, (5) 1.25h, (6) 1.5h, (7) 1.75h, (8) 2.0h, (9) 2.25h, (10) 2.5h, (11) 3.0h

The reaction rate constant was $6.877\text{E-}3 \text{ min}^{-1}$, $6.477\text{E-}3 \text{ min}^{-1}$, $8.267\text{E-}3 \text{ min}^{-1}$, and $6.877\text{E-}3 \text{ min}^{-1}$ at the initial concentration of RhB, $2.8 \mu\text{M}$, $5.8 \mu\text{M}$, $6.8 \mu\text{M}$, and $11.2 \mu\text{M}$, respectively.

In general, it is known that the rate constant of a reaction decreases as the initial concentration of reactants increases^{14,15}. However, the rate constant of the reaction was almost unchanged in this

study because the range of the initial concentration of RhB was not wide enough to change the rate constant of the reaction within the experimental range.

The rate constant of the reaction was unaffected by the flow rate of the influent within the range of 20 L/min to 36 L/min because the reaction between photocatalysts and reactants occurred within a very short time(Fig. 9). In this study, the average rate constant was approximately $7.05E-3 \text{ min}^{-1}$ in IWCR.

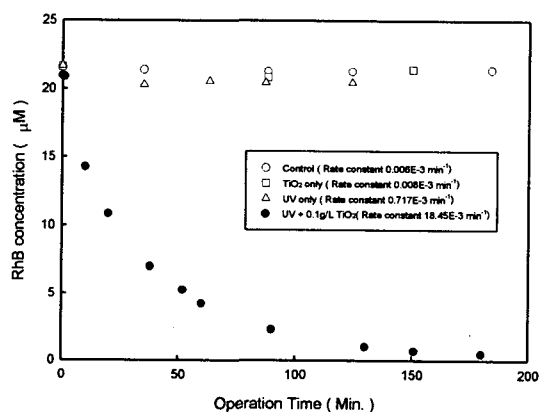

Fig. 9. The effects of photocatalyst and UV illumination on the decolorization of RhB($20 \mu\text{M}$) in a slurry reactor. \circ : Control, \square : UV only, \triangle : TiO_2 1g/L, \bullet : UV and TiO_2 (0.1 g/L)

3.3. PFBR

The X-ray diffraction(Rigaku Model D/Max-2400) of TiO_2 film was measured and an X-ray diffraction pattern for 2θ diffraction angles was between 0° and 120° . Three primary peaks can be seen at 25.3° , 37.9° and 48° . They can be assigned to diffraction from anatase(JCPDS No.

21-1272).

In PFBR with four lamps(20W) using Photomedia, the rate constant was $11.84E-3 \text{ min}^{-1}$. The effects of the UV lamps only were shown to be infinitesimal, due to their high but negligible energy(Fig. 10). The batch experiment in PFBR showed that efficiency increased as the number of lamps increased. Fig. 11 shows the results of the continuous operation of RhB conducted for 20 days in PFBR. It could be shown that high efficiency was maintained throughout the operation period, and it is noteworthy that more than 90 % efficiency was maintained for the first 7 days.

3.4 Comparison of the reaction rate constants of reactors

Table 2 represents the reaction rate constant of each reactor when varying the reaction conditions.

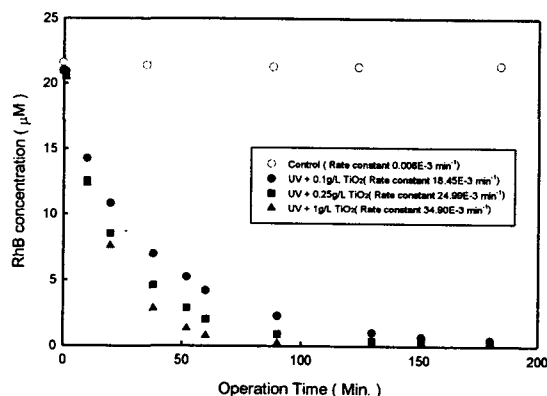

Fig. 10. The effects of photocatalyst and UV illumination on the decolorization of RhB($20 \mu\text{M}$) in a slurry reactor. \circ : Control, \bullet : UV and TiO_2 (0.1 g/L), \blacksquare : UV and TiO_2 (0.25 g/L), \blacktriangle : UV and TiO_2 (1.0 g/L)

Table 2. The comparison of photocatalytic reactors

Reactors	Volume	UV Lamp	Reaction Rate Constant	Note
Surry Reactor	500 mL	20W	$8 \sim 36E-3 \text{ min}^{-1}$	Lamp Number 1 TiO_2 0.1g/L ~ 4g/L
Inner Wall Coated Reactor(IWCR)	1,000 mL	20W	$7E-3 \text{ min}^{-1}$	Lamp Number 1
Photocatalytic Fluidized Bed Reactor(PFBR)	24,000 mL	20W	$5 \sim 12E-3 \text{ min}^{-1}$	Lamp number 1~4 Photomedia 2.7 % V/V

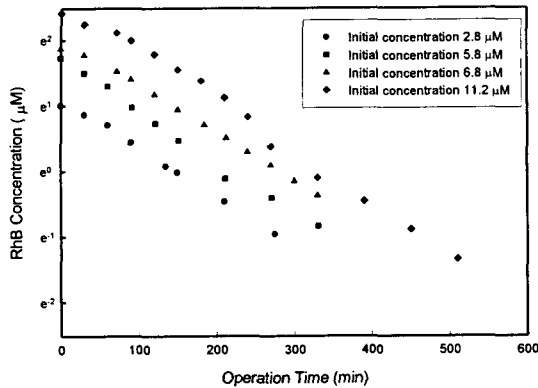

Fig. 11. Variations of RhB concentration with operation time at different initial concentration in IWCR.

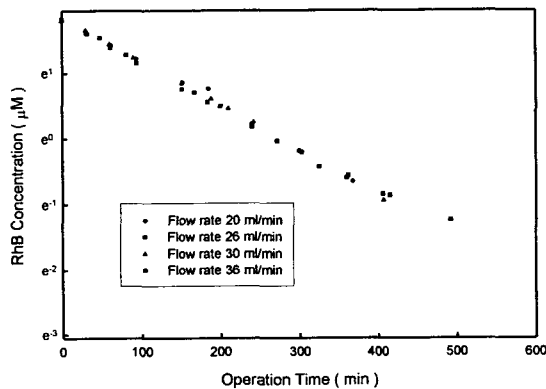

Fig. 12. Variations of RhB concentration at different flow rates during the operation time in IWCR (rate constant $7.05E-3 \text{ min}^{-1}$).

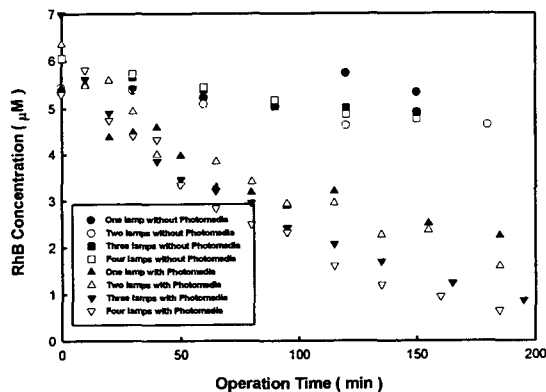

Fig. 13. The effect of UV intensity in PFBR. Rate constant ($\times 1E-3 \text{ min}^{-1}$) ● : 0.121, ○ : 0.905, ■ : 1.403, □ : 1.654, ▲ : 5.057, △ : 6.837, ► : 10.087, ▷ : 11.835 (Photomedia 2.7 % V/V).

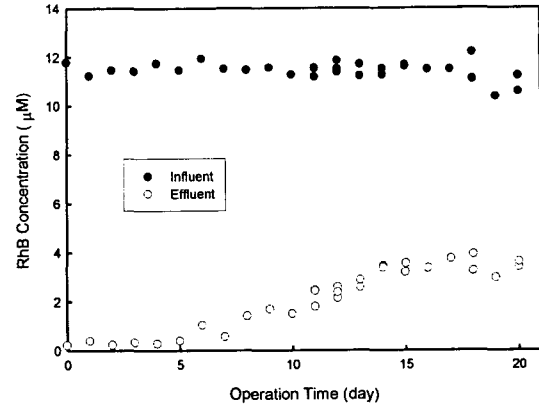

Fig. 14. Variation of RhB concentration with operation time in PFBR (HRT 12 hour).

The reaction rate constant in slurry reactor was $8E-3 \text{ min}^{-1} \sim 36E-3 \text{ min}^{-1}$ when the concentration of the TiO_2 powder was varied from 0.1 g/L to 4.0 g/L. The approximate surface area of the TiO_2 powder agglomerate was $0.0084 \text{ m}^2/\text{g TiO}_2/\text{L}_{\text{solution}}$, assuming that the pore of the catalyst agglomerate was negligible, because the mean diameter of the TiO_2 powder agglomerate was 238 nm at pH 7 (Particle analyzer, OTSUKA, Japan) and its density was $3,000 \text{ kg/m}^3$. Also, the reaction rate constant was $8E-3 \text{ min}^{-1}$ and the reacting surface area was $8.8 \text{ m}^2/\text{L}_{\text{solution}}$, when the reaction volume of IWCR was 700 ml and the volume of the feed tank was 300 ml. In the fluidized reactor, the ratio of the volume of one Photomedia to the reactor volume was 2.7 % and the reacting surface area to the reacting volume was about $0.108 \text{ m}^2/\text{L}_{\text{solution}}$ because the surface area of one Photomedia was about $7.07E-6 \text{ m}^2$ and the mean density was about 900 kg/m^3 , assuming that the pore of the Photomedia was negligible.

In this study, it was difficult to compare each reactors about the reacting surface area to the reacting volume and the performance, because reactors have different shapes and the photocatalyst is supplied into a reactor in one of three ways : suspension in a solution, the coating on a surface by TiO_2 powder, and the coating on a particle by TiO_2 -sol. The surface area of each reactor is approximately as large as IWCR ($8.8 \text{ m}^2/\text{L}_{\text{solution}}$) > PFBR ($0.108 \text{ m}^2/\text{L}_{\text{solution}}$) > Slurry reactor ($0.0336 \text{ m}^2/\text{L}_{\text{solution}}$), but the reaction rate constant of each reactor is as large as the slurry reactor ($36E-3 \text{ min}^{-1}$

when the TiO_2 concentration is 4.0 g/L) > PFBR ($12\text{E-}3 \text{ min}^{-1}$) > IWCR ($7\text{E-}3 \text{ min}^{-1}$). The reaction rate constant of IWCR, which has the largest reacting surface area to the reacting volume, was the lowest among three reactors, and the constant of the reaction rate of the slurry reactor, which has the lowest surface area to reacting volume, was the highest. This indicates that the slurry reactor had the most efficient performance. However, PFBR has its advantages : the filtration of photocatalyst is unnecessary ; the reactor has a large reaction rate constant, compared with that of IWCR ; and the loss of a photocatalyst dose not occur.

4. Conclusion

The decolorization of RhB with TiO_2 only or UV only decreased slightly, but in the presence of both TiO_2 and UV light, more than 95% of RhB photodegraded within 60 minutes. When both TiO_2 and UV light are present, the color of the RhB was almost completely decolorized in photocatalytic reactors(slurry reactor, IWCR, PFBR), confirming that titanium dioxide can easily break up the structure of a dyes chromophore.

Results were analyzed in terms of reaction rates and the surface area per reaction volume. The surface area of each reactor is approximately as large as IWCR ($8.8 \text{ m}^2/\text{L}_{\text{solution}}$) > PFBR ($0.108 \text{ m}^2/\text{L}_{\text{solution}}$) > Slurry reactor ($0.0336 \text{ m}^2/\text{L}_{\text{solution}}$ when the TiO_2 concentration is 4.0 g/L), but the reaction rate constant of each reactor is as large as the slurry reactor ($36\text{E-}3 \text{ min}^{-1}$ when the TiO_2 concentration is 4.0 g/L) > PFBR ($12\text{E-}3 \text{ min}^{-1}$) > IWCR ($7\text{E-}3 \text{ min}^{-1}$). When the rate constant of the reaction is considered only, the slurry reactor was more efficient than IWCR and PFBR. But when every condition is considered, even though the reaction rate constant of PFBR was lower than that of the slurry reactor, PFBR had the advantages in that the filtration of the photocatalyst is unnecessary and a wash-out of the photocatalyst can be avoided.

Acknowledgements

This study was supported financially by the Korea Science and Engineering Foundation

through the Institute for Environmental Technology and Industry(IETI), Pusan National University, Korea(Project number:99-10-02-02-A-3)

References

- [1] Reynaldo D. Barreto, Kimberly A. Gray, and Krista Anders, 1995, Photocatalytic degradation of methyl-tert-butyl ether in TiO_2 slurries : a proposed reaction scheme. *Water Research*, 29, 1243 ~ 1248.
- [2] Paola Calza, Claudio Minero, Anastasia Hiskia, Elias Papacostantinou, and Ezio Pelizzetti, 1999, Photolytic and photocatalytic decomposition of bromomethanes in irradiated aqueous solutions. *Applied Catalysis B : Environmental*, 21, 191 ~ 202.
- [3] Dingwang Chen and Ajay K. Ray, 1999, Photocatalytic kinetics of phenol and its derivatives over UV irradiated TiO_2 . *Applied Catalysis B : Environmental*, 23, 143 ~ 157.
- [4] Turch, C. S. and Ollis, D. F., 1990, Photocatalytic degradation of organic water contaminants : Mechanisms involving hydroxyl radical attack. *J. catalysis*, 122(1), 178 ~ 192.
- [5] Bahnemann, D., Bockelmann, D. and Goslich, R., 1991, Photochemical system for the removal of poisons from polluted waters. *DECHEMA Monogr.* 124, 261 ~ 281.
- [6] Roberto L. Pozzo, José L. Giombi, Miguel A. Baltanás and Alberto E. Cassano, 2000, The performance in a fluidized bed reactor of photocatalysts immobilized onto inert supports. *Catalysis Today*, 62, 175 ~ 187.
- [7] Ying Ma, Jian-bin Qiu, Ya-an Cao, Zi-shen Guan and Jian-nian Yao, 2001, Photocatalytic activity of TiO_2 films grown on different substrates. *Chemosphere*, 44(5), 1087 ~ 1092.
- [8] Koichi Kobayakawa, Chotaro Sato, Yuichi Sato and Akira Fujishima, 1998. Continuous-flow photoreactor packed with titanium dioxide immobilized on large silica gel beads to decompose oxalic acid in excess water. *Journal of Photochemistry and Photobiology A : Chemistry*, 118(1), 65 ~ 69.
- [9] Wonyong Choi, Joung Yun Ko, Hyunwoong Park and Jong Shik Chung, 2001, Inves-

- tigation on TiO₂-coated optical fibers for gas-phase photocatalytic oxidation of acetone. *Applied Catalysis B : Environmental*, 31(3), 209~220.
- [10] Ren-De Sun, Akira Nakajima, Itaru Watanabe, Toshiya Watanabe and Kazuhito Hashimoto, 2000, TiO₂-coated optical fiber bundles used as a photocatalytic filter for decomposition of gaseous organic compounds. *Journal of Photochemistry and Photobiology A : Chemistry*, 136, 111~116.
- [11] H. Poelman, D. Poelman, D. Depla, H. Tomaszewski, L. Fiermans and R. De Gryse, 2001, Electronic and optical characterisation of TiO₂ films deposited from ceramic targets. *Surface Science*, volumes 482~485, Part 2, 940~945.
- [12] Piscopo A, Robert D, Marzolin C, Weber JV, 2000, TiO₂ supported on glass fiber for the photocatalytic degradation of benzamide. *Journal of materials science letters*, 19(8), 683~684.
- [13] Suzuko Yamazaki, Saori Matsunaga, Kenzi Hori, 2001, Photocatalytic degradation of trichloroethylene in water using TiO₂ pellets. *Water Research*, 35, 1022~1028.
- [14] Dingwang Chen and Ajay K. Ray, 1998, Photodegradation Kinetics of 4-Nitrophenol in TiO₂ suspension. *Wat. Res.*, 32(11), 3223~3234.
- [15] Matthews, K. W., 1987, Solar-electric water purification using photocatalytic oxidation with TiO₂. *Solar Energy*, 38(6), 405~413.