

Effect of Chip Spacing in a Multichip Module on the Heat Transfer for Paraffin Slurry Flow

Mingoo Choi

Present affiliation: LG Production Engineering Research Center

Keumnam Cho*

School of Mechanical Engineering, Sungkyunkwan University

The experiments were conducted by using water and paraffin slurry to investigate the effect of a chip spacing in the multichip module on the cooling characteristics from an in-line 4×3 array of discrete heat sources which were flush mounted on the top wall of a channel. The experimental parameters were chip spacing in a multichip module, heat flux of simulated VLSI chip, mass fraction of paraffin slurry, and channel Reynolds number. The removable heat flux at the same chip surface temperature decreased as the chip spacing decreased at the first and fourth rows. The local heat transfer coefficients for the paraffin slurry were larger than those for water, and the chip spacing on the local heat transfer coefficients for paraffin slurry influenced less than that for water. The enhancement factor for paraffin slurry showed the largest value at a mass fraction of 5% regardless of the chip spacing, and the enhancement factors increased as the chip spacing decreased. This means that the paraffin slurry is more effective than water for cooling of the highly integrated multichip module.

Key Words : Paraffin Slurry, Chip Spacing, Multichip Module, Enhancement Factor

Nomenclature

A : Surface area (m^2)
 D_h : Hydraulic diameter (m)
 EF : Enhancement factor
 h : Heat transfer coefficient ($W/m^2 \cdot K$)
 H : Channel height (cm)
 L_h : Chip length (m)
 L_{MCM} : Length of the test section (m)
 ΔP : Pressure drop (Pa)
 q'' : Heat flux (W/cm^2)
 R : Resistance (Ohm)
 Re_{Db} : Reynolds number ($=\rho_f \cdot U \cdot D_h/\mu_f$)
 S_h : Chip spacing (m)
 T : Temperature ($^{\circ}C$)
 U : Average velocity (m/s)

V : Voltage (V)
 W : Channel width (cm)
 x : Mass fraction of paraffin slurry (%)

Greek letters

δ : Uncertainty
 μ : Viscosity ($N \cdot s/m^2$)
 ρ : Density (kg/m^3)

Subscripts

f : Working fluid
 m : Mixture of paraffin slurry and water
 p : Paraffin
 s : Chip surface
 w : water

* Corresponding Author,

E-mail : Keumnam@yurim.skku.ac.kr

TEL : +82-31-290-7445 ; **FAX** : +82-31-290-5849

School of Mechanical Engineering, Sungkyunkwan University, 300 Chunchun-dong, Jangan-ku, Suwon, Kyung-gi-do 440-746, Korea. (Manuscript Received January 28, 2000, Revised June 8, 2000)

1. Introduction

A multichip module technology has been introduced to improve the performance significantly by minimizing the level of packaging (Ginsberg and Schnorr, 1994). This is a packag-

ing technique that places several semiconductor chips, interconnected in a high density substrate, into a single package. The multichip modules offer several advantages such as reduced weight and size, increased reliability and enhanced performance. As the density of an active silicon increased, the power dissipation per single chip has increased dramatically in recent years (Nakayama, 1997; Pautsch and Bar-Cohen, 1999). For high-heat-flux application, the effective liquid cooling method must be used that can keep the surface temperature of chips with a high heat flux within a certain temperature limit.

In many practical applications involving a multichip module, chip spacing in the multichips module is one of the most important parameters because present trends in electronic industry indicate that the packaging density will continue to increase, resulting in increased power densities at the module level. The power density that must be dissipated by individual chips will rise at a rapid rate. Therefore, the objective of present study is to investigate the effect of the chip spacing in a multichip module on the cooling characteristics

by water and phase change material slurry. The application of phase change material slurry as an active liquid cooling method is attractive for thermal management of high power electronics due to its potential benefits: thermal conductivity enhancement, latent heat, etc. (Sohn and Chen, 1984; Choi and Cho, 1999).

2. Experimental Apparatus

The schematic diagram of the present experimental apparatus is shown in Fig. 1. The apparatus consisted of a main test section, a constant temperature bath, a power supply, a mass flow meter, a pump, a data acquisition system etc.

The test section consisted of a rectangular channel with aspect ratio of 0.2, which yielded the most efficient cooling performance when the heat transfer and pressure drop were considered simultaneously (Choi and Cho, 2000) and a multichip module as shown in Fig. 2. The multichip module had an in-line 4×3 array of discrete heat sources simulating VLSI chips, and it was flush-mounted on the top wall of a horizontal rectangular chan-

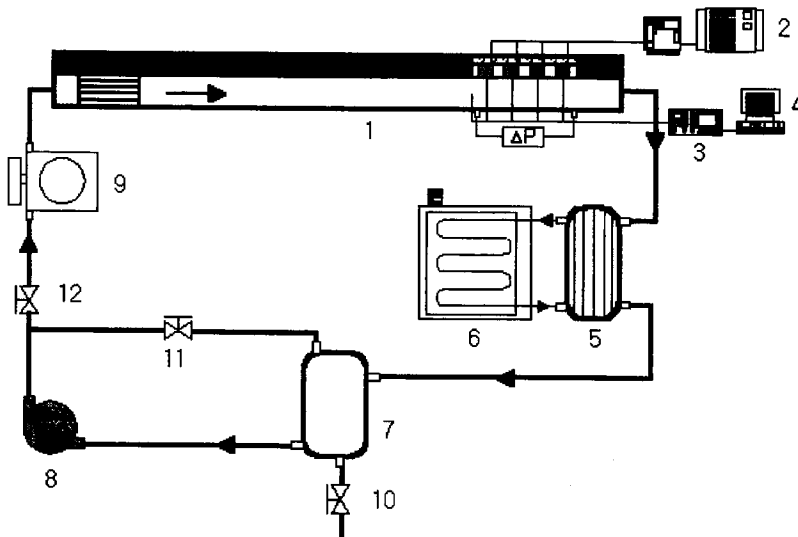

- | | |
|------------------------------|------------------------|
| 1. Rectangular channel | 2. DC power supply |
| 3. Data acquisition system | 4. Personal computer |
| 5. Plate-type heat exchanger | 6. Constant temp. bath |
| 7. Receiver tank | 8. Pump |
| 9. Mass flow meter | 10~12. Valves |

Fig. 1 Schematic diagram of the present experimental apparatus

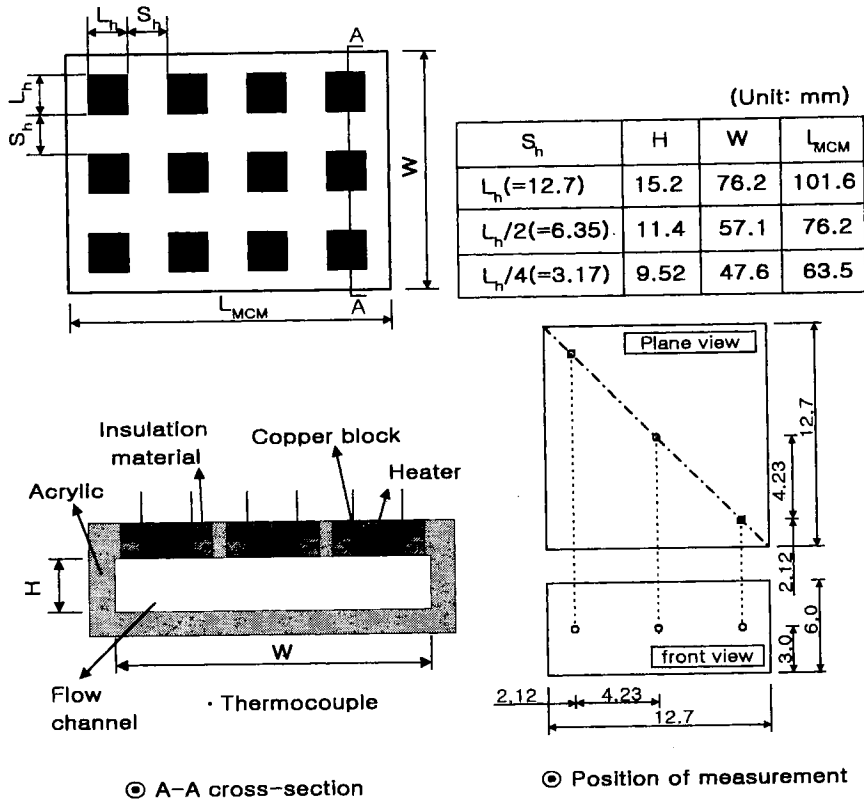

Fig. 2 Details of the present test section

nel. The multichip module with three different chip spacings was located at a downstream location 50 times of the hydraulic diameter from the inlet of the test section, where flow was hydrodynamically fully developed. A honeycomb section was located at the inlet of the channel to make the flow uniform. Two static pressure taps were located at the bottom wall just before and after the test section and connected to an U-tube manometer to measure the pressure drop across the test section. A heating wire with a resistance of $18.6 \pm 0.2 \Omega$ as a heat source was attached to each chip by silicon glue. Six heating wires on the chips were connected in parallel to a power supply with an accuracy of $\pm 0.03V$ to supply uniform heat flux to each heater. Each heat source had a square shape with a size of 1.27cm, a typical size for a VLSI chip. A copper heat sink with a thickness of 6mm was attached at the bottom of each chip, and the top side was thermally insulated by fiberglass to force the heat

flow only to the channel. The copper heat sink was a square shape with the same size as the heater. The temperatures were measured at the three positions for each heat sink by type T thermocouples inserted through the machined holes as shown in Fig. 2. The maximum temperature difference at three positions on the copper heat sink was approximately $0.5^\circ C$. Therefore, the average of three temperatures was used as a surface temperature. The thermocouples were calibrated within an accuracy of $\pm 0.15^\circ C$ by a standard RTD.

The present experiments were performed with two different types of solutions: water and paraffin slurry. A commercial grade paraffin ($C_{22}H_{46}$) was used, which had a melting temperature of $43.6^\circ C$ and a fusion energy of $175.6 kJ/kg$ measured by a DSC (Differential Scanning Calorimeter). The measurement uncertainty of melting temperature by the DSC was $0.8^\circ C$ from the calibration data with distilled water. Thermophysical prop

Table 1 Properties of paraffin waxes

Melting temperature (°C)		43.6
Heat of fusion (cal/g)		42.1
Specific heat (cal/g · °C)	Liquid(at 60 °C)	0.60
	Solid	0.71
Thermal conductivity (W/m · K)	Liquid(at 60 °C)	0.17
	Solid	0.24
Density (g/cm ³)	Liquid(at 60 °C)	0.76
	Solid	0.82
Viscosity (cP)(at 60 °C)		3.14
Molecular weight (g/mol)		332

erties of the paraffin are presented in Table 1.

A conduction analysis was performed on the heat source and the substrate using the values of thermal conductivities for copper block (386W/m · K), acrylic (0.2W/m · K), thermal silicon (1.5W/m · K), and insulation (0.02W/m · K). The heat loss from the heater to the surrounding ranged from 2.5 to 3.2% within the whole experimental range and was compensated in the calculation of heat flux.

Three key experimental parameters were the chip spacings in a multichip module of Lh/4, Lh/2, Lh, the heat flux of 10, 20, 30, 40 W/cm², the mass fraction of paraffin slurry of 0, 2.5, 5, 7.5%, and the channel Reynolds number from 5,300 to 16,000. The heat flux was obtained by dividing the heat supplied to each chip by the chip area. The Reynolds number was calculated by using the hydraulic diameter of the rectangular channel.

The local heat transfer coefficient was calculated by dividing the heat flux supplied to each chip by the temperature difference between the surface temperature of the chip and the mean fluid temperature at each heat source as shown in Eq. (1). The mean fluid temperature was obtained by energy balance using heat flux and the fluid temperatures at the inlet and outlet of each heat source. And this led to the average fluid temperature at each heat source. The local heat transfer coefficients in the present study represented the average of heat transfer coefficients across the

three columns in each row. The heat flux was obtained using the supplied voltage and the resistance of heater as shown in Eq. (1).

$$h = \frac{q''}{(T_s - T_f)} = \frac{V^2}{RA_s} / (T_s - T_f) \quad (1)$$

The equations for uncertainty analysis of the local heat transfer coefficient and the heat flux are shown in Eqs. (2) ~ (3) by following the procedure in literature (Moffat, 1985).

$$\frac{\delta h}{h} = \sqrt{\left(\frac{\partial q''}{q''}\right)^2 + \left(\frac{\delta T_s}{T_s - T_f}\right)^2 + \left(\frac{\delta T_f}{T_s - T_f}\right)^2} \quad (2)$$

$$\frac{\delta q''}{q''} = \sqrt{\left(\frac{\delta R}{R}\right)^2 + \left(2\frac{\delta V}{V}\right)^2 + \left(2\frac{\delta L_h}{L_h}\right)^2} \quad (3)$$

The uncertainties of T_s , T_f , resistance, voltage, and the chip length were 0.65°C, 0.15°C, 0.2Ω, 0.03V and 0.02mm, respectively within the whole experimental range. The uncertainty of the heat flux was ±1.2% for both water and paraffin slurry and the uncertainties of the local heat transfer coefficient were ±3.8% for water and ±4.1% for paraffin slurry.

The size of paraffin slurry was controlled by the amount of an emulsifier. The density of paraffin was smaller than that of water, so that the particles floated. Therefore, the size of the paraffin particles had to be small enough to prevent from clogging flow loop. When the concentration of the emulsifier to the mass fraction of the paraffin was 3.3%, the size of the paraffin slurry particles ranged from 10 to 40μm.

The density of the paraffin slurry are obtained by the following equations (Shook, 1993):

$$\frac{1}{\rho_m} = \frac{\left(\frac{x}{100}\right)}{\rho_p} + \frac{\left(1 - \left(\frac{x}{100}\right)\right)}{\rho_w} \quad (4)$$

which can be used for the slurries of very fine, mono-size, spherical particles.

The relationship between the viscosity and concentration of the suspension of paraffin slurry with the error range within 5% is proposed by the following equation (Shook, 1993):

$$\frac{\mu_m}{\mu_w} = 1 + 3.08\left(\frac{x}{100}\right) + 15.29\left(\frac{x}{100}\right)^2 + 0.00273\exp\left(20.47\left(\frac{x}{100}\right)\right) \quad (5)$$

3. Results and Discussion

Figure 3 shows the removable heat flux ranges for each chip spacing by using water with respect to the chip surface temperatures at the first and fourth rows of the multichip module at a channel Reynolds number of 16,000. The removable heat flux ranges for the first and fourth rows at the same chip surface temperature decreased with the chip spacing. The reason is that the area of a multichip module becomes small as the chip spacing decreases, and this results in the increasing of the heat flux of the multichip module. When the heat flux ranges for a single chip of 10 ~ 40W/cm² were applied to the multichip modules of which chip spacings were L_h , $L_h/2$, and $L_h/4$, the heat flux ranges for each multichip module were 2.5~10.0, 4.5~17.8, and 6.4~25.6W/cm² respectively. However, as shown in Fig. 3, the rate of the increase for the surface temperature was relatively small in spite of such an increase of heat flux at the multichip module level. This was due to the influence of the hydraulic diameter of a rectangular channel. The hydraulic diameter of a rectangular channel decreased with the chip spacing and therefore, the average fluid velocity increased at the same Reynolds

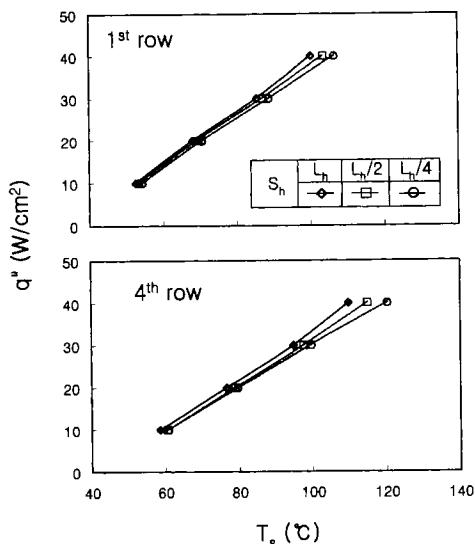

Fig. 3 Removable heat flux for water with respect to the chip surface temperature ($Re_{Dh} = 16,000$)

number. For the maximum heat flux of 40W/cm², the chip surface temperatures for the chip spacings of L_h , $L_h/2$, and $L_h/4$ were 100.2, 103.5, and 106.5°C respectively for the first row, and 109.8, 114.9, and 120.3°C respectively for the fourth row. Table 2 shows the heat flux ranges removed by water for the first and fourth rows when the limited chip surface temperature is 85°C.

Figure 4 shows the heat flux range removed by the paraffin slurry with a mass fraction of 7.5% with respect to the chip surface temperature at the first and fourth rows of the multichip module at a channel Reynolds number of 16,000. The heat flux ranges for the paraffin slurry with a mass fraction of 7.5% were higher than those for water at the same chip surface temperature. For the maximum heat flux of 40W/cm², the chip surface temperatures for the chip spacings of L_h , $L_h/2$, and $L_h/4$ were 89.3, 91.9, and 93.3°C respectively

Table 2 Removable heat flux range for water (W/cm²)

Row No.	L_h	$L_h / 2$	$L_h / 4$
1	29.8	28.9	27.9
4	24.4	23.2	22.6

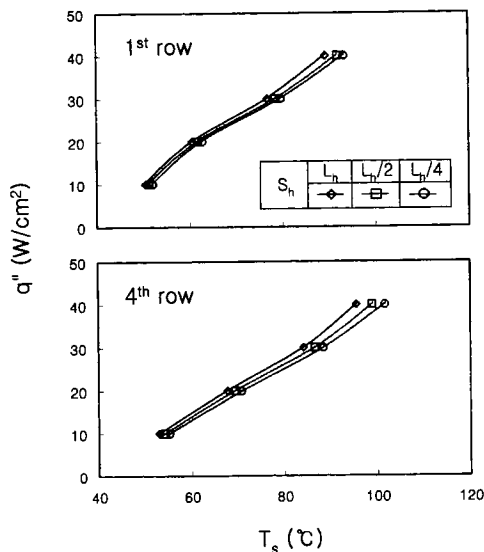

Fig. 4 Removable heat flux for 7.5 % paraffin slurry with respect to the chip surface temperature ($Re_{Dh} = 16,000$)

at the first row, and 95.6, 98.9, and 101.7°C respectively at the fourth row. Table 3 shows the heat flux ranges removed by the paraffin slurry with a mass fraction of 7.5% for the first and fourth rows when the limited chip surface temperature is 85°C.

Figure 5 shows the local heat transfer coefficients for water and the paraffin slurry with a mass fraction of 7.5% with respect to the row number at a channel Reynolds number of 16,000. The local heat transfer coefficients increased with the chip spacing, and the difference of the local heat transfer coefficients between the chip spacing of $L_h/2$ and L_h was relatively greater than that between the chip spacing of $L_h/4$ and $L_h/2$. This means that the cooling performance decreases seriously with the chip spacing. The local heat transfer coefficients reached an uniform value approximately after the fourth row (seven times of the chip length). This meant that the thermally fully developed condition was reached after the fourth row regardless of the chip spacing. But actually, the entrance length for thermally fully developed condition becomes short as the chip spacing decreases. The reason is that the determination of thermally fully developed region generally depends on the channel Reynolds number and Prandtl number. As the chip spacing

decreases, the fluid temperature at each heat source increases, and thus the density and viscosity values included in the channel Reynolds number and Prandtl number decrease. The local heat transfer coefficients for paraffin slurry with a mass fraction of 7.5% were larger than those for water. The reason for the heat transfer enhancements was due to the particle migration and subsequent collision against the wall in turbulent flows and the latent heat of paraffin. Transverse migration of particles adjacent to a surface can aid in both disrupting the laminar sublayer and increasing the heat transfer coefficient. The latent heat of paraffin, which can be viewed as a form of specific heat, increases the heat transfer coefficient because the heat transfer coefficient increases as an one-third power of the specific heat for turbulent flows. This means that paraffin slurry shows better cooling performance than water. The chip spacing in the multichip module on the local heat transfer coefficients for paraffin slurry influenced less than that for water.

Figure 6 shows the pressure drop for water and paraffin slurry with a mass fraction of 7.5% in the present test section as a function of Reynolds number. The lengths of the test section with each chip spacing are different, and thus the pressure

Table 3 Removable heat flux range for 7.5 % paraffin slurry (W/cm^2)

Row No.	L_h	$L_h / 2$	$L_h / 4$
1	36.6	34.8	33.8
4	30.5	29.0	27.8

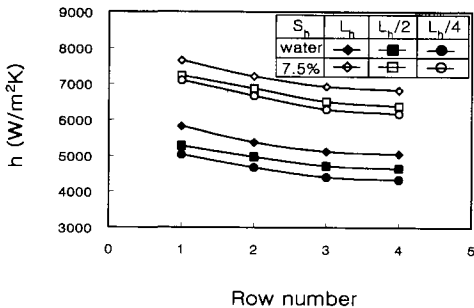

Fig. 5 Local heat transfer coefficients for water and 7.5 % paraffin slurry with respect to the row number ($Re_{Dh} = 16,000$)

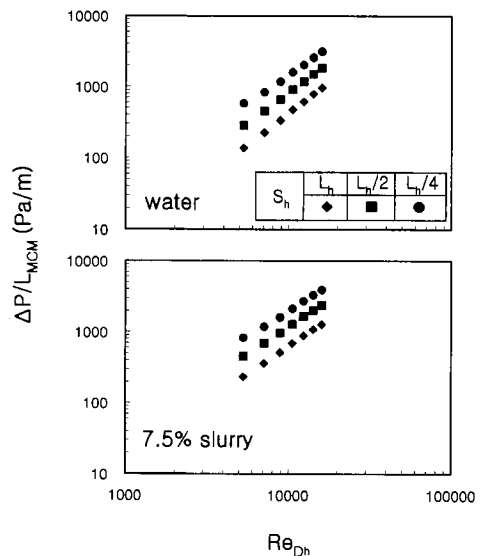

Fig. 6 Pressure drop for water and 7.5 % paraffin slurry in the present test section

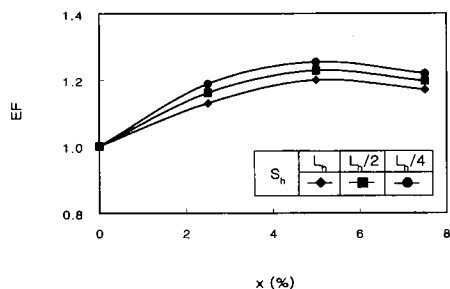

Fig. 7 Enhancement factor at the fourth row ($Re_{Dh}=16,000$)

drop is divided by the length of the test section as shown in Fig. 6. The pressure drop data for paraffin slurry with a mass fraction of 7.5% were larger than those for water for all three cases of the chip spacing. The reason is that the average fluid velocity for paraffin slurry is larger than that for water at the same channel Reynolds number since the kinematic viscosity of paraffin slurry is greater than that of water. For both water and paraffin slurry with a mass fraction 7.5%, the pressure drop per unit length of the test section increased at the same Reynolds number as the chip spacing decreased. This is due to the difference of the hydraulic diameters of the rectangular channels for each chip spacing. The minimum chip spacing of $L_h/4$ had the maximum average fluid velocity at the same Reynolds number, and this made the maximum pressure drop. For paraffin slurry with a mass fraction of 7.5%, the pressure drop per unit length of the test section for the chip spacing of $L_h/2$ is 1.94 times larger than that for L_h , and pressure drop for $L_h/4$ is 3.53 times larger than that for L_h .

Figure 7 shows the enhancement factors (EFs) for three chip spacings at the fourth row at a Reynolds number of 16,000. Note that the enhancement factor is defined as:

$$EF = \frac{h^+}{\left(\frac{\Delta P}{L_{MCM}}\right)^+} \quad (6)$$

where h^+ is the ratio of the local heat transfer coefficient of paraffin slurry to that for water, and $(\Delta P / L_{MCM})^+$ is the ratio of the pressure drop per unit length of the test section for paraffin slurry to that for water. The enhancement factors

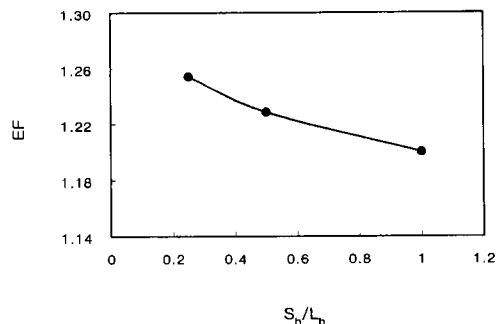

Fig. 8 Enhancement factor for 5% paraffin slurry with respect to the chip spacing ($Re_{Dh}=16,000$)

for paraffin slurry showed the largest value at a mass fraction of 5% regardless of the chip spacing. The higher the paraffin mass fraction the more heat transfer is expected. However, the reason why the peak of EF occurs at a mass fraction of 5% is the pressure drop. The increasing rate of pressure drop with the mass fraction of particles is greater than that of heat transfer. Therefore, the EF does not increase linearly with the mass fraction because of corresponding changes in the pressure drop.

Figure 8 shows the enhancement factors for paraffin slurry with a mass fraction of 5% with respect to the chip spacing at a Reynolds number of 16,000. The enhancement factors increased as the chip spacing decreased. The enhancement factors for the chip spacings of L_h , $L_h/2$, and $L_h/4$ were 1.20, 1.23, and 1.25, respectively. The effect of latent heat of paraffin slurry became great as the chip spacing decreased because the melting rate of the paraffin particles on the heating surfaces increased. This means that the paraffin slurry is more effective than water for the cooling of the highly integrated multichip module.

4. Conclusions

A summary of the present study is given below.

- (1) The removable heat flux at the same chip surface temperature decreased with the chip spacing at the first and fourth rows.
- (2) The local heat transfer coefficient for paraffin slurry was larger than that for water due to

the particle migration and subsequent collision against wall in turbulent flows and the latent heat of paraffin. The chip spacing in the multichip module on the local heat transfer coefficients for paraffin slurry influenced less than that for water.

(3) The measured pressure drop per unit length of the multichip module increased at the same Reynolds number as the chip spacing decreased due to the difference of the hydraulic diameter of the rectangular channel for each chip spacing.

(4) The enhancement factor for paraffin slurry showed the largest value at a mass fraction of 5% regardless of the chip spacing, and the enhancement factors increased as the chip spacing decreased. This means that paraffin slurry is more effective than water for cooling of the highly integrated multichip module.

Acknowledgement

The authors wish to acknowledge the financial support of the Korea Research Foundation (1998-018-E00018) in the program of 1998, and in part by the Brain Korea 21 Project.

References

Choi, M., Cho, K., 1999, "Liquid Cooling for a Multichip Module using Fluorinert Liquid and

Paraffin Slurry," *Int. J. Heat Mass Transfer*, Vol. 43, No. 2, pp. 209~218.

Choi, M., Cho, K., 2000, "Influence of an Aspect Ratio of Rectangular Channel on the Cooling Performance of a Multichip Module," *KSME Int. J.*, Vol. 14, No. 3, pp. 350~357.

Ginsberg, G. L. and Schnorr, D. P., 1994, "Multichip Modules and Related Technologies," *McGraw-Hill*, New York.

Moffat, R. J., 1985, "Using Uncertainty Analysis in the Planning of Experiment," *J. Fluid Engineering*, Vol. 107, pp. 173~182.

Nakayama, W., 1997, "Liquid-cooling of Electronic Equipment: Where does it Offer Viable Solutions?," *Advances in Electronic Packaging*, EEP-Vol. 19-2, pp. 2045~2052.

Pautsch, G. and Bar-Cohen, A., 1999, "Thermal Management of Multichip Modules with Evaporative Spray Cooling," *Proceedings of the Pacific Rim/ASME International and Inter-society Electronic and Photonic Packaging Conference*, Hawaii, pp. 1453~1461.

Shook, C. A., 1993, "Slurry Pipeline Flow," *Processing of Solid-Liquid Suspensions*, Shamlou, P. A. Ed., *Butterworth-Heinemann Ltd.*, Oxford, pp. 287~309.

Sohn, C. W., Chen, M. M., 1984, "Heat Transfer Enhancement in Laminar Slurry Pipe Flows with Power Law Thermal Conductivities," *ASME J. Heat Transfer*, Vol. 106, pp. 539~542.