

Detection of OH(A²Σ⁺) and O(¹D) Emission Spectrum Generated in a Pulsed Corona Plasma

Dong Nam Shin,[†] Chul Woung Park, and Jae Won Hahn*

*Optical High Temperature Measurement Group, Korea Research Institute of Standards and Science,
P.O. Box 102, Yusong, Taejeon 305-600, Korea
Received September 14, 1999*

We have constructed a pulsed corona discharge system for the removal of air pollutants, such as NO_x, SO_x and volatile organic compounds (VOCs), in which an emission spectrometry is employed to characterize the generation of excited species by the corona discharge process. Special attention has been paid to overcome noise problems from high voltage power supply, which hampers the measurement of emission light, by using separate ground and trigger modules for emission spectrometry. The emission spectra between dry and humid gas mixtures have shown remarkable differences in the region of 305-309 nm wavelength, corresponding with OH(A²Σ⁺) emission to its ground state. This result implies that the OH emission spectra generated by the corona discharge can be used to monitor the chemical reaction of OH radical responsible for the removal of air pollutants.

Introduction

Recently the use of the non-thermal plasma process has been considered a viable option to treat flue gas because it is very suitable for producing reactive radicals, which can be used to remove trace contaminants effectively without heating all the species comprising the system.^{1,2} In the non-thermal process, a number of the chemically active species (CAS), including radicals, ions and highly excited molecules, are initially generated by the corona discharge. CAS reacts with pollutants, NO_x, SO_x and volatile organic compounds (VOCs), to form final stable products such as nitric acid, sulfuric acid and CO₂.

In general, it is well accepted that air pollutants is removed by the reaction with N, O, OH, HO₂ and ozone species in the plasma.^{1,2} Under the condition of dry air and room temperature, however, there have been many experimental results showing that the main processes responsible for removing the pollutants depend on the reaction of O₃, because the lifetime of ozone generated by non-thermal plasma is very long, effectively taking part in these processes.^{3,4} But, the efficiency of the ozone formation is hampered significantly by the presence of water.^{4,5} Since the great majority of flue gas contains some water vapor, it is believed that OH radical generated by corona discharge serve as an important species to remove pollutants in these processes.^{1,2,6} Recently, for example, Weschler and Shields have shown the importance of the OH radical's role in the removal of VOCs, where the OH-mediated pathways for the oxidation of saturated organics proceed 2-5 orders of magnitude faster than some processor for O₃ pathways.⁷ This is due to the fact that the rate constant for the reaction of VOCs with OH radical is more than five orders of magnitude higher compared with O₃.⁸

The influence of water molecules on the removal of NO_x is of interest in the non-thermal plasma processes. The presence of water species in flue gas enhances the removal efficiency of NO_x through the formation of ionic cluster of NO_x with water molecules.^{9,10} In addition, the water molecule is believed to be a significant source of OH radical in flue gas, formed by the electron impact dissociation of water.^{1,2} It is considered that OH radical is prominently involved in the simultaneous removal of NO_x and SO_x by non-thermal plasma as follows:

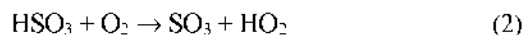
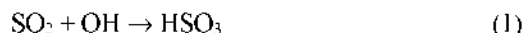

Therefore, the presence of SO_x is found to enhance the removal greatly compared with NO_x alone,^{6,11-12} where it is noteworthy that the OH radical plays an important role in oxidation of NO_x and SO_x.

There have been experimental studies detecting OH concentration in corona discharge systems through spectroscopic methods.¹³⁻¹⁷ These studies were facilitated by the convenience of getting information on the concentration of radical species having short life times. Most recently, Hibert and coworkers¹³ have shown that an average OH(X²T) concentration can be measured by the resonant absorption spectroscopic method, where two serial corona reactors are used: one used as a ultraviolet (UV) pulse source for spectroscopic investigation, the other as a real reactor. However, a large body of experiments has been performed in argon- and helium-water mixtures, or using the very complicated spectroscopic tools such as laser-induced fluorescence (LIF).^{14,16} Therefore, it is necessary to use less complex spectroscopic methods to monitor chemical processes that occur during the corona discharge.

[†]Present address: Atmospheric Environmental Protection Department, National Institute for Resources and Environment, Agency of Industrial Science and Technology, Japan.

In the present study, an attempt is made to elaborate on a simple experimental method to obtain information on the electronically excited species generated by the corona discharge at atmospheric pressure. We made a positive pulsed corona discharge system since it is one of the efficient methods for CAS production.^{17,18} The main scope of this study is the construction of a the corona discharge system having an optical emission spectrometer and, then, the examination of the optical emission from the electronically excited species such as N₂(C³Π_u or B³Π_g), O(¹D) and OH(A²Σ⁻) generated by corona discharge. The possibility of using the emission spectra of the OH radical to monitor the chemical reaction involved in the removal of air pollutants is also discussed.

Experimental Section

The experimental illustration, shown in Figure 1, consists mainly of three parts: (A) corona discharge reactor and power supply, (B) optical emission measurement and (C) gas handling manipulator.

(A) Corona Discharge Reactor and Power Supply. The outer electrode, made of stainless steel tube (SUS 304), has a tubular shape with a 34 mm inner diameter and a 400 cm³ discharge volume. Inside is a 0.5 mm diameter tungsten wire centered on the tube axis. Two quartz windows attached to both ends along the outer electrode allow longitudinal observation of the optical emission from the corona discharge. The capacitance of the present reactor can be characterized by the geometry of the reactor¹⁹

$$C = \frac{2\pi\epsilon_0 l}{\ln\left(\frac{R}{r}\right)} \approx 4pF \quad (6)$$

where ϵ_0 is the dielectric constant in a vacuum, l is the length of the reactor, R and r are the radius of outer and inner electrodes, respectively. Therefore, the capacitor of 190 pF was used to effectively transmit the charged electricity into the reactor. For the coaxial discharge reactor, the electric field strength and the voltage initiating corona discharge are given by the respective expressions.¹⁹

$$E_c = 31 \delta \left(1 - \frac{0.308}{\sqrt{\delta r}}\right) \quad (7)$$

$$V_c = E_c r \ln(R/r) \quad (8)$$

Here, δ is the density ratio of the used gas mixture to air at 1 atm and 300 K. For the present experimental conditions, the minimum values are on the order of 100 kV/cm and 10 kV, respectively. Therefore, the stable generation of corona discharge can occur at an applied voltage of more than 10 kV.

The electric circuit for supplying electric power into the reactor is also shown in Figure 1. The high-voltage D.C. power source (Glassman ER60N5) was connected directly to the charging capacitor, which is triggered by a spark gap switch (EG&G GP-41B). Pulse frequency was varied up to 50 Hz with a trigger module (EG&G TM11A). The present power system generated positive high voltage pulses reaching maximum 34 kV. The discharge characteristic curves were recorded with both voltage and current probes connected to a transient digitizer (Hewlett Packard HP54510A).

(B) Optical Emission Measurement. Figure 2 shows schematically the optical emission system. The emission from the corona is focused on the input slit of monochromator (Jovin Yvon HR320 with a 1800 grs/mm grating) equipped with a Hamamatsu R955 photomultiplier tube (PMT). Signals from the PMT are analyzed with BOXCAR Integrator (Stanford Research SR250). To improve the signal to noise ratio, the optical emission measurement system was synchronized with the high-voltage pulse power source.

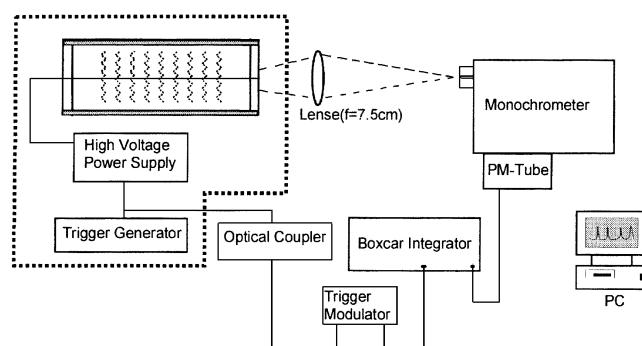

Figure 2. Schematic diagram for the optical emission measurement.

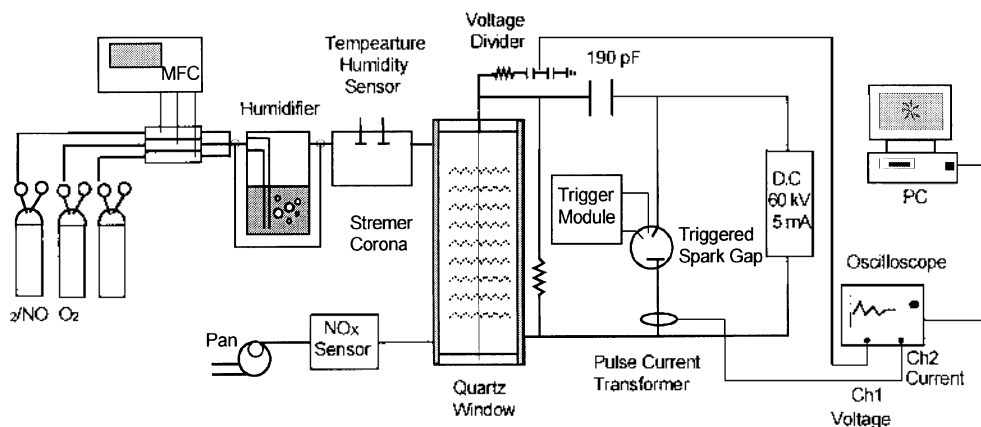

Figure 1. Schematic diagram of corona discharge experimental system.

To avoid noise originating from the high voltage pulse source, the ground of the optical emission part was separated from the ground of the pulse source with an optical coupler. In addition, the trigger module was used to adjust the pulse duration and width getting BOXCAR to overcome the malfunctioning of BOXCAR due to the discharge noise. The emission spectra were recorded by scanning monochromator, which was stepped in 0.1 nm increment under the control of a PC. The signals were accumulated for 20 pulses.

(C) Gas Manipulator and Chemicals. In this study, the intensity of OH emission was measured as a function of water concentration within N₂ gas. Mass flow controllers (MKS 1479) were used to control flow rate of the gases. When water was added to the gas mixture, a pure N₂ gas was directed through a reservoir containing distilled water held at room temperature. This saturated N₂ gas was mixed with the other gases within the mixing chamber, where are attached temperature and humidity sensors, and, then, the mixed gas was introduced in the discharge reactor. Thus, the water vapor concentration can be changed by controlling rate of the N₂ flow rate bubbling through the water reservoir. In this experiment, N₂ (99.99% Deasung Sanso), O₂ (99.99% Deasung Sanso) and distilled water were used without further purification.

Results and Discussion

In the non-thermal corona discharge processes, it is well known that the energized electrons dissociate and ionize the background gas molecules within a very short time, followed by the chemical reaction of pollutants with CAS generated by plasma.¹ Considering that the common composition of the flue gas consists of N₂ (more than 70%), O₂, H₂O and CO₂ species, it is not surprising that the probability of getting energy from electron collision on N₂ gas molecules would be much larger than for other gases. Therefore, it is important to study N₂ emission spectrum from corona discharge to differentiate emission of CAS from N₂ emission spectra.

In this study N₂ emission was always observed to have a strong intensity in the region of 200-800 nm. Figure 3 shows a typical N₂ emission spectrum, where the first and the second positive bands corresponding to the transitions between B³Π_g and A³Σ_u⁺ and between C³Π_u and B³Π_g electronic states, respectively.²⁰ A³Σ_u⁺, B³Π_g and C³Π_u electronic states are lying at 5.5, 7.4 and 11.0 eV above the ground electronic state, respectively.²¹ The electron mean energy within the non-thermal plasma depends on the experimental conditions such as gas composition and applied voltages. According to a simple analytic calculation the electron mean energy is estimated to be about 2-5 eV, which is sufficient to excite the electronic states of the background molecules by high-energy electrons in the tail part of Boltzmann distribution.¹ As shown in Figure 3, a large number of N₂ molecules are excited in the plasma, giving strong emission spectra in the wavelength region around 340 nm.

For the non-thermal processes, it has been considered that

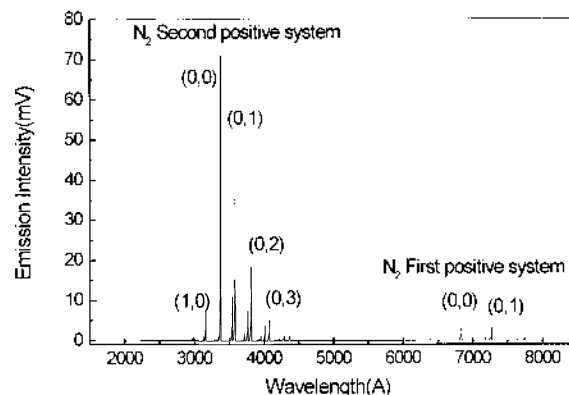

Figure 3. Typical N₂ emission spectrum showing the first (C³Π_u → B³Π_g) and the second (B³Π_g → A³Σ_u⁺) positive transitions in the range of 200-800 nm wavelength. (v', v'') designates vibrational quantum numbers for higher and lower electronic states, respectively.

OH radical is mainly produced through the following two pathways



where *e* represents an electron and O(¹D) is an O atom generated by the electron impact dissociation of O₂ molecule. The main pathway leading to OH radical by corona discharge is thought to result in the direct dissociation of water molecules by electron impact through (9). Recently, however, Ono and Oda have reported that the generation of OH radical increases as the concentration of O₂ molecule increases, which indicates that the reaction channel (10) also takes part in generating OH radical.¹⁴

In the corona discharge process, the majority of the O(³P or ¹D) atom production comes from the direct dissociation of O₂ molecules by electron impact. According to the calculation by Penetrante *et al.*,¹ the calculated G-values (number of species per 100 eV of input energy) for the formation of the O(¹D) atom is nearly half that for O(³P) atom in dry air mixture. In this study, however, no emission spectrum originated from excited O₂ and O species was observed in the air mixture. When the corona discharge was made in pure O₂ gas, only the weak emission of O atom corresponding to the transition of O(¹D) to O(³P) states was only observed, as shown

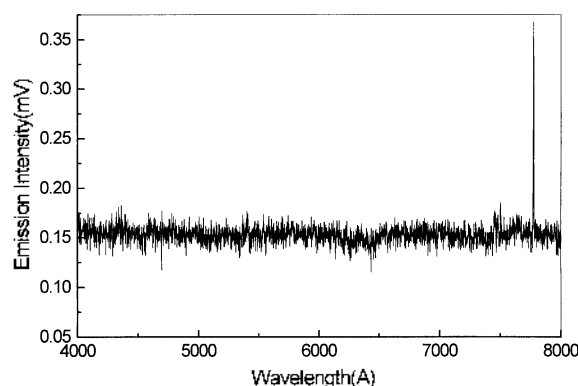

Figure 4. Observed emission spectrum for the transition of O(¹D) to O(³P) states generated from pure O₂ gas.

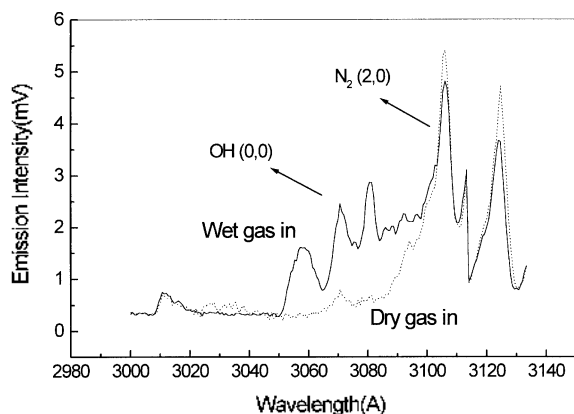

Figure 5. Observed $\text{OH}(\Lambda^2\Sigma^-)$ emission spectra with dry (solid line) and humid (dotted line) N_2 gas, respectively.

in Figure 4. In this study, the possible reason for the absence in air or the weak emission in pure oxygen of $\text{O}({}^1\text{D})$ species generated by corona discharge is not clearly elucidated. While the life time of the radiationless collisional quenching with background gases is relatively short not as long as tens, the radiative decay time of $\text{O}({}^1\text{D})$ into its ground state is reported to be about 150 s.²² Therefore, it is thought that the initially generated $\text{O}({}^1\text{D})$ would either be easily deactivated to its ground state, $\text{O}({}^3\text{P})$, by the radiationless collision process between background gases of N_2 and O_2 or react with H_2O molecule to give OH radical, before the radiational decay of $\text{O}({}^1\text{D})$ species to its ground state proceeds.

As mentioned previously, the major source of OH radical is through reaction pathway (9), where it is well known that the generation of OH radical in electronically ground state is the dominant process. In addition, there is the possibility of the formation of OH radical in the first electronic excited state, $\text{OH}(\Lambda^2\Sigma^1)$.

The results on emission spectra of dry and humid gases are shown in Figure 5. A comparison with both emission spectra, shows a marked change in the range of 305–309 nm wavelength region. This difference is attributed to the fact that the transition of the first electronically excited $\text{OH}(\Lambda^2\Sigma^1)$ radical to its ground state is dependent on the concentration of water within the gas mixture. As mentioned previously, this strongly suggests that there is the formation of the $\text{OH}(\Lambda^2\Sigma^1)$ radical in addition to the electronic ground OH radical by corona discharge.

The influence of water concentration on OH emission also has been investigated as displayed in Figure 6. The OH radical intensity taken at 308 nm largely increases when the water concentration reaches 20%, then slowly increases up to 50%, and, after which it is constant regardless of water concentration because there are not enough electrons to dissociate water molecules. As mentioned, fortunately the dominant emission region of the $\text{OH}(\Lambda^2\Sigma^1)$ radical is does not overlap with that of the N_2 species of the major background constituents. These results show that the extent of the generation of $\text{OH}(\Lambda^2\Sigma^1)$ radical could be used to qualitatively to indirectly monitor the total concentration of OH radical by corona discharge, although the intensity of the OH emission

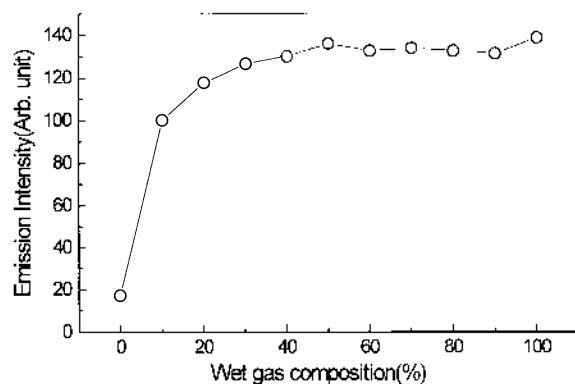

Figure 6. The emission intensity of $\text{OH}(\Lambda^2\Sigma^1)$ radicals generated by corona discharge as a function of the concentration of water vapor within N_2 gas.

does not warrant a detailed quantization of the OH radical. Since it is well known that OH radical provides the dominant path for the removal of a variety of atmospheric pollutants, the simultaneous observations of OH emission and efficient removal of trace air pollutants are currently under investigation, focusing on their chemical reactions in the removal of air pollutants within the pulsed high voltage corona discharge processing.

Conclusion

We have constructed a pulsed corona discharge system capable of measuring the emitted light from plasma by means of emission spectrometry. To avoid noise originating from the high voltage pulse generator and to increase the signal to noise ratios, separate ground and trigger modules for the emission spectrometry were used in this system. The optical emission spectra from excited N_2 , $\text{O}({}^1\text{D})$ and OH ($\Lambda^2\Sigma^1$) species have been observed successfully.

In this study, it is observed that the dominant emission region of $\text{OH}(\Lambda^2\Sigma^1)$ radical does not overlap with the emission of the N_2 species and that the intensity of the $\text{OH}(\Lambda^2\Sigma^1)$ radical depends strongly on the water concentration in the gas mixture. These experimental results suggest the possibility that the OH radical emission spectra can be used to monitor chemical reactions related to OH radical involved in the removal of air pollutants. In further studies, the relationship between the intensity of OH radical emissions and the removal efficiency of the air pollutants has to be investigated to explore the chemical processes in the presence of water or H_2O_2 /water mixture within the corona discharge process.

Acknowledgment. This research was supported by Korean Ministry of Science and Technology under the project number 99-0609-100.

References

1. *Non-Thermal Plasma Techniques for Air Pollution Control: Part A-Overview, Fundamentals and Supporting Technologies, Part B-Electron Beam and Electrical Discharge Processing*; Penetrante, B. M., Schultheis, S. E.,

- Eds.: Springer: Berlin, 1993.
- Matzing, H. *Adv. Chem. Phys.* **1991**, 80, 315.
 - Mok, Y. S.; Nam, L. -S. *IEEE Trans. Ind. Appl.* **1998**, 26, 5.
 - Mukkavilli, S.; Lee, C. K.; Varghese, K.; Tavlarides, L. L. *IEEE Trans. Ind. Appl.* **1988**, 16, 652.
 - Wu, M. C.; Kelly, N. A. *Appl. Catal. B* **1998**, 18, 79.
 - van Veldhuizen, F. M.; Rutgers, W. R.; Bityurin, V. A. *Plasma Chem. Plasma Proc.* **1996**, 16, 227.
 - Weschler, C. J.; Shields, H. C. *Environ. Sci. Technol.* **1996**, 30, 3250.
 - Atkinson, R. *Chem. Rev.* **1986**, 86, 69.
 - Matzing, H.; Paur, H. -R.; Bunz, H. *J. Aerosol. Sci.* **1988**, 19, 883.
 - Smith, D.; Adams, N. G. *Top. Curr. Chem.* **1980**, 89, 1.
 - Paur, H. -R.; Jordan, S. *J. Aerosol. Sci.* **1989**, 20, 7.
 - Lyon, R. K.; Cole, J. A.; Kramlich, J. C.; Chen, S. L. *Combust. Flame* **1990**, 81, 30.
 - Hibert, C.; Gaurand, I.; Motret, O.; Pouvesle, J. M. *J. Appl. Phys.* **1999**, 85, 7070.
 - Ono, R.; Oda, T. In *Proc. Asia-Pacific Workshop Advanced Oxidation Technologies: Innovation and Commercial Application*. Tuskuba, Japan, 1998; p 66-69.
 - de los Aecos, T.; Domingo, C.; Herrero, V. J.; Sanz, M. M.; Schulz, A.; Tanarro, I. *J. Phys. Chem. A* **1998**, 102, 6282.
 - Coogan, J. J.; Sappey, A. D. *IEEE Trans. Plasma Sci.* **1996**, 24, 91.
 - Mizuno, A.; Kurahashi, M.; Imano, S.; Ishida, T.; Nagata, M. *IEEE IAS annu. meeting*: New Orleans, USA, 1997; p 86-90.
 - Chang, J.-S.; Lawless, P.; Yamamoto, T. *IEEE Transaction on Industry Applications* **1991**, 19, 1152.
 - Yuri P. Raizer, *Gas Discharge Physics*: Springer-Verlag: Berlin, Germany, 1991; p 347.
 - Gallimberti, I.; Hepworth, J. K.; Klewe, R. C. *J. Phys. D: Appl. Phys.* **1974**, 7, 880.
 - Simsek, M.; Babicky, V.; Clupek, M.; DeBenedictis, S.; Dilecce, G.; Sunka, P. *J. Appl. Phys. D: Appl. Phys.* **1998**, 31, 2591.
 - Okabe, H. *Photochemistry of Small Molecules*: Wiley: New York, 1978.
-