

<논 문>

Active Control of Harmonic Signal Based on On-line Fundamental Frequency Tracking Method

실시간 기본주파수 추종방법에 근간한 조화 신호의 능동제어

Sunmin Kim and Youngjin Park

김 선 민* · 박 영 진*

(Received June 3, 2000 ; Accepted October 4, 2000)

Key Words: Active Noise Control(능동소음제어), Fundamental Frequency(기본주파수), Reference Generator(기준 신호 발생기), Beating Phenomena(맥놀이 현상)

ABSTRACT

In this paper, a new indirect feedback active noise control (ANC) scheme based on the fundamental frequency estimation is proposed for systems with a harmonic noise. When reference signals necessary for feedforward ANC configuration are difficult to obtain, the conventional ANC algorithms for multi-tonal noise do not measure the reference signals but generate them with the estimated frequencies.⁽⁴⁾ However, the beating phenomena, in which certain frequency components of the noise vanish intermittently, may make the adaptive frequency estimation difficult. The confusion in the estimated frequencies due to the beating phenomena makes the generated reference signals worthless. The proposed algorithm consists of two parts. The first part is a reference generator using the fundamental frequency estimation and the second one is the conventional feedforward control. We propose the fundamental frequency estimation algorithm using decision rules, which is insensitive to the beating phenomena. In addition, the proposed fundamental frequency estimation algorithm has good tracking capability and lower variance of frequency estimation error than that of the conventional cascade ANF method.⁽⁴⁾ We are also able to control all interested modes of the noise, even which cannot be estimated by the conventional frequency estimation method because of the poor S/N ratio. We verify the performance of the proposed ANC method through simulations for the measured cabin noise of a passenger ship and the measured time-varying engine booming noise of a passenger vehicle.

요 약

본 논문에서는 고조파 소음을 내는 시스템의 기본 주파수 추정을 통한 새로운 피드백 능동소음제어 방법을 제안한다. 기준신호를 측정하기 어려운 상황에서 종래의 다중 정현파 소음의 능동제어 방법은 기준신호를 측정하는 대신 추정된 주파수를 이용하여 기준신호를 만들어낸다.⁽⁴⁾ 그러나 맥놀이현상(beating phenomenon)이 존재할 때는 순간적으로 특정 주파수 성분이 사라지게 되므로 적응 주파수 추정이 어렵게 되어 맥놀이현상에 의한 주파수 추정에서의 혼돈은 만들어진 기준신호를 쓸모없게 만든다. 제안된 알고리즘은 두 가지 부분으로 구성된다. 첫째는 기본주파수 추정을 이용한 기준신호 발생기이고 둘째는 기존의 피드포워드 제어 부분이다. 제안된 결정 규칙을 이용한 기본주파수 추정알고리즘은 맥놀이현상에 둔감할 뿐 아니라 기존의 직렬형 적응노치필터 방법에 비해 좋은 추종성과 적은 주파수 추정 오차의 분산을 갖는다.⁽⁴⁾ 더욱이 신호대잡음비가 좋지 않아 기존의 주파수 추정방법으로는 추정될 수 없는 주파수 성분까지 제어가 가능하다. 제안된 능동소음제어 방법의 성능을 검증하기 위해서 실측한 선박의 객실 소음과 자동차의 시변하는 엔진부밍소음에 대해서 모의 실험을 수행한다.

* Member, Dept. of Mechanical Engineering, KAIST
Taejon, 305-701, Korea

1. Introduction

An effort to cancel the noise by superposing a sound with the opposite phase of the noise, which is called the active noise control (ANC), has been widely studied. ANC is very effective especially against low frequency noise below 500 Hz, which is hard to reduce by passive means.^(1,2)

Active control of the harmonic noise has received a great deal of attention because rotating or reciprocating machinery such as engines or fans induces the harmonic noise.^(3,4) As mentioned above, we can obtain good performance for the harmonic noise using a feedforward control method only when a reference is available. ANC with reference generator, which estimates the frequencies of the periodic noise, has been studied when a reference is not available. Typical example is active control of an exhaust engine noise in the cabin of a passenger ship.⁽⁴⁾

In this paper, a new indirect feedback ANC algorithm is proposed for the harmonic noise. Firstly, we estimate the fundamental frequency of the noise signal in the controlled field. Secondly, we generate the harmonic signal with the estimated fundamental frequency and use it as reference signal in the conventional feedforward ANC configuration. If the fundamental frequency of the noise is exactly estimated, the scheme will be identical to the conventional normalized feedforward method that measures harmonics directly, except that the smaller order of the adaptive controller may be used because the reference signal of the proposed method has no measurement noise.

Consider the noise signal with the beating phenomena. The closer two beating frequencies get, the longer the vanishing duration becomes. In this case, certain harmonic components vanish and reappear repeatedly and it causes drift in the estimated frequencies. Therefore, the conventional frequency estimation methods might not estimate the frequencies of the noise during the vanishing periods.

We propose a new fundamental frequency estimation algorithm for harmonic noise with the beating phenomena. Decision rules based on harmonic constraints filter out the erroneous estimation caused by the beating phenomena. Then, we estimate the fundamental frequency with only

well estimated components of the noise. Therefore, we can avoid the effect of the beating phenomena and keep the tracking capability of frequency estimation intact. In order to verify the feasibility of the proposed method we simulate the proposed method for the measured cabin noise of a passenger ship and time-varying engine booming noise of a vehicle.

2. On-line Fundamental Frequency Tracking Method

2.1 Frequency Estimation Method Based on the Cascade Adaptive Notch Filter

The problem of estimating the frequencies of multiple sinusoids buried in noise has received considerable attention of researchers in the field of signal processing.^(4, 5) The frequency estimation method using the cascade adaptive notch filter (ANF) has superior performance for harmonic noise in terms of computational efficiency, convergence rate and threshold SNR.⁽⁴⁾ Notations of this paper follow those of the reference.⁽⁴⁾

Figure 1 shows the block diagram of the frequency estimation method based on the cascade ANF. The cascade ANF is composed of p notch filters, $N_k(z^{-1})$ of order 2 in series to estimate p frequencies of p sinusoids. When we adapt each notch filter to minimize the squared error of each section, the central notch frequencies of the notch filters become the frequencies of the sinusoidal signal $x(n)$.

Equation (1) shows the transfer function of the notch filter with constrained poles and zeros, where q^{-1} indicates one-step delay operator. Tuning variable ρ , called a pole contraction factor, is a positive real number close to but smaller than 1 and is related to the bandwidth of the notch and n is a time index.

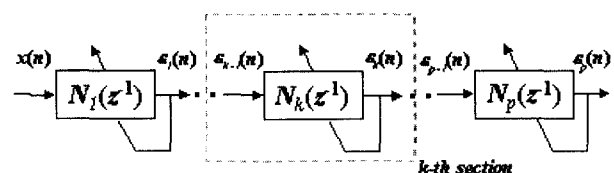

Fig. 1 Block diagram of the cascade ANF method.

$$\begin{aligned}\varepsilon_k(n) &= N_k(q^{-1})\varepsilon_{k-1}(n) = \frac{A_k(q^{-1})}{A_k(\rho q^{-1})} \varepsilon_{k-1}(n) \\ &= \frac{1 + a_k(n)q^{-1} + q^{-2}}{1 + \rho a_k(n)q^{-1} + \rho^2 q^{-2}} \varepsilon_{k-1}(n), \\ k &= 1, 2, \dots, p.\end{aligned}\quad (1)$$

We adapt the parameter $a_k(n)$ of the notch filters by the linearized minimal parameter estimation method based on recursive least squares method.⁽⁴⁾ The adaptation algorithm⁽⁴⁾ is derived as follows:

$$\tilde{\varepsilon}_{k(n)} \equiv \frac{1}{A_k(\rho q^{-1})} \varepsilon_{k-1}(n) \quad (2)$$

$$= \varepsilon_{k-1}(n) - \rho a_k(n-1) \tilde{\varepsilon}_k(n-1) - \rho^2 \tilde{\varepsilon}_k(n-2)$$

$$\Phi_k(n) = \lambda \Phi_k(n-1) + \tilde{\varepsilon}_k(n-1)^2 \quad (3)$$

$$z_k(n) = \lambda z_k(n-1) + \tilde{\varepsilon}_k(n-1) \{ \tilde{\varepsilon}_k(n) + \tilde{\varepsilon}_k(n-2) \} \quad (4)$$

$$a_k(n) = -\Phi_k(n)^{-1} z_k(n), \quad k=1, 2, \dots, p. \quad (5)$$

where λ is a forgetting factor and $\tilde{\varepsilon}_k(n)$ defined in equation⁽²⁾ is the signal enhancing the periodic components of the error, $\varepsilon_{k(n)}$.

Each section is adapted by the equations (2)~(5) sequentially. The frequencies of the sinusoidal signal $x(n)$ are obtained from the central notch frequencies calculated as follows:

$$\hat{f}_k(n) = \frac{1}{2\pi} \cos^{-1} \left(-\frac{a_k(n)}{2} \right), \quad k=1, 2, \dots, p \quad (6)$$

We estimated the tonal frequencies of the noisy signal measured in the cabin of a passenger ship with constant speed to obtain more realistic results. Fig. 2 and 3 show

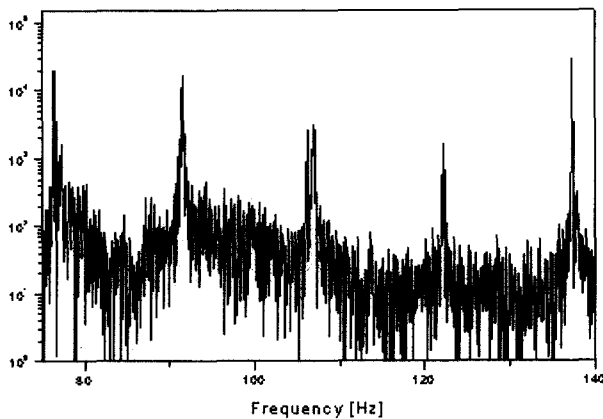

Fig. 2 Spectrum with high resolution

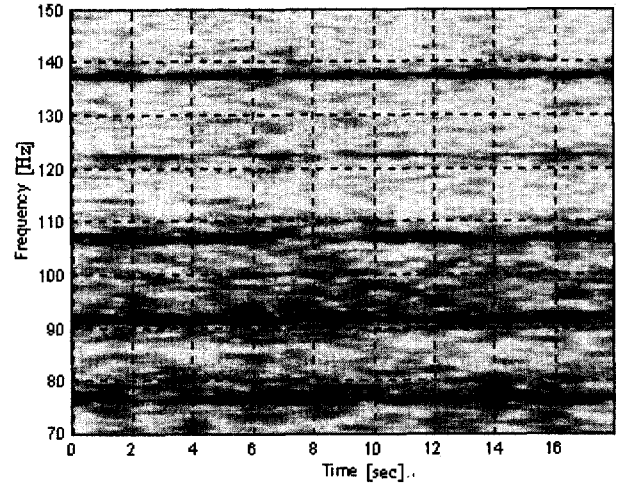

Fig. 3 Periodogram of cabin noise of a passenger ship.

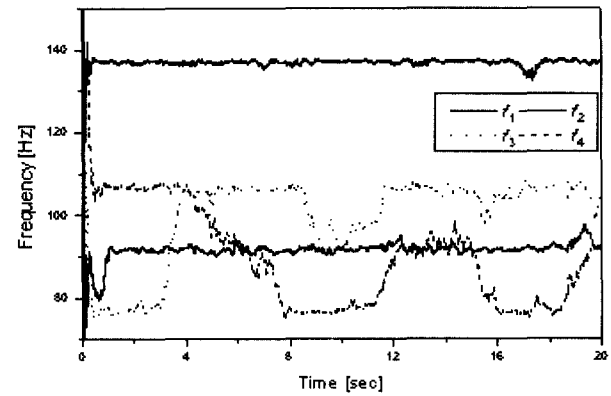

Fig. 4 Estimated frequencies drifted due to beating phenomena.

the steady-state power spectrum and the periodogram of the noisy harmonic signal, respectively. According to the spectrum analysis of the signal, higher order harmonics in range of 70 Hz~160 Hz are dominant. Moreover, we observed the beating phenomena according to the spectrum analysis with very high resolution in Fig. 2 and the vanishing harmonic components intermittently as shown in Fig. 3, time-frequency plot.

Even after the complete convergence, the frequency estimation was confused during the vanishing duration as shown in Fig. 3 and 4. Figure 4 shows the frequency estimation results of the signal by the cascade ANF method.

We propose the fundamental frequency estimation method in the next section, which is able to avoid the drifting effect caused by the beating phenomena.

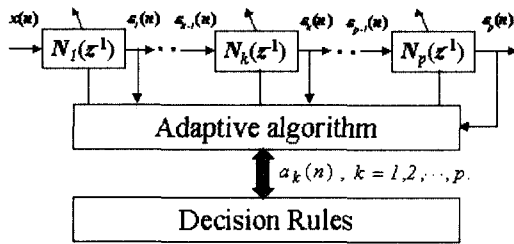

Fig. 5 The schematic diagram of the frequency estimation method with decision rules.

2.2. Decision Rules Using Harmonic Constraints

In general, rotating or reciprocating machinery such as engines or fans induces the harmonic noise. We propose the fundamental frequency estimation method for the harmonic noise. Firstly, we estimate the frequencies of the harmonic signal by the cascade ANF method. Secondly, we filter out the effect of drifting components among the estimated frequencies caused by the beating phenomena by using the decision rules. Thirdly, we estimate the fundamental frequency of the harmonic signal with only well-estimated frequencies. We assume that it is previously known which order harmonics are dominant and the orders of the dominant modes are time-invariant. Take care that it does not mean the fundamental frequency is time-invariant. The schematic diagram of the frequency estimation method with decision rules is shown in Fig. 5.

Decision rules use harmonic constraints, which are obtained from the mode order assumption. The fundamental frequency is obtained by dividing each estimated frequency with its previously known mode order. We construct decision rules as follows:

I. Confirm the convergence of the frequency estimation by checking whether all the estimation values are in allowable variance. (The next step is conducted after convergence.)

II. Sort the estimated frequencies.

III. Calculate p fundamental frequencies $\Delta\hat{f}_k(n)$ from p notch filters as follows:

$$\Delta\hat{f}_k(n) = \frac{\hat{f}_k(n)}{m_k}, \quad m_k = \text{mode order}, \quad k=1,2,\dots,p \quad (7)$$

IV. Check whether each of calculated fundamental frequencies is inside a tolerance bound.

V. Estimate the fundamental frequency through

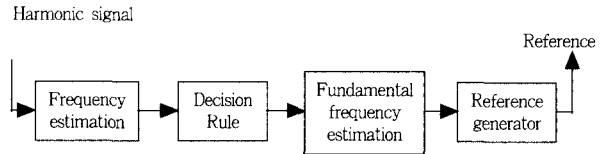

Fig. 6 The schematic diagram of the reference generation method.

averaging the fundamental frequencies inside the tolerance bound as follows:

$$\Delta f(n) = \frac{1}{p_1} \sum_{k=1}^{p_1} \Delta\hat{f}_k(n) \quad (8)$$

where p_1 is the number of the well-estimated fundamental frequencies.

Note that variance of the estimation error can be reduced due to the averaging effect. This property is derived in Appendix A. See also Appendix B for the convergence checking algorithm.

2.3 Fundamental Frequency Tracking

As mentioned in the above section, we estimate the fundamental frequency by averaging the fundamental frequencies selected by the decision rules. The proposed method is not affected by the drifting effect caused by the beating phenomena because the decision rules filters out the erroneous frequency estimation components. Moreover, the method is able to keep the fast tracking capability of the cascade ANF method intact.⁽⁴⁾

The reference generation part and how to use it for a feedforward ANC configuration will be mentioned in the next section. Figure 6 shows the schematic diagram of the reference generation method.

3. Active Control of Harmonic Noise

3.1 Reference Generation for Feedforward ANC

We generate the reference signal for feedforward ANC configuration by using the fundamental frequency and known mode order. The conventional ANC method with reference generator based on the frequency estimation⁽⁴⁾ generates the reference signal from the estimated frequencies. Therefore, disturbance components, which cannot be estimated by the frequency estimation method, cannot be used as the reference.⁽⁴⁾ However, the proposed

method generates the reference signal, which includes all frequency components of the disturbance noise. The reference signal $r(n)$ is generated as follows:

$$r(n) = \sum_{k=1}^l \sin\left(2\pi \sum_{i=0}^n f_k(i)\right). \quad (9)$$

where l is the number of the modes of the interested disturbance noise. In equation (9), the frequency $f_k(n)$ is as follows:

$$f_k(n) = m_{a,k} \times \Delta f(n) \quad (10)$$

where $k=1,2,\dots,l$, and $m_{a,k}$ is the mode order of the frequency whose magnitude should be reduced.

3.2 ANC with Reference Generator

It is necessary to estimate the disturbance signal from the error signal so as to estimate the fundamental frequency of the disturbance noise. We use the internal model control (IMC) technique to estimate the disturbance signal.^(4, 6) Figure 7 shows block diagram of ANC with reference generator.

In Fig. 7, The $W(z)$, the $H(z)$, and the $\hat{H}(z)$ are a controller filter, a cancellation path, and a model of the cancellation path, respectively. Reference generator is the block of the proposed approach mentioned in section 2. The $d(n)$ and the $\hat{d}(n)$ are a disturbance noise and an estimate of $d(n)$, respectively. The lower part of the block diagram is equivalent to a block diagram of the filtered- x LMS algorithm.⁽⁷⁾ The upper part of the block diagram consists of both the part to estimate $d(n)$ and the part to estimate the fundamental frequency of $\hat{d}(n)$ and to generate the reference signal.

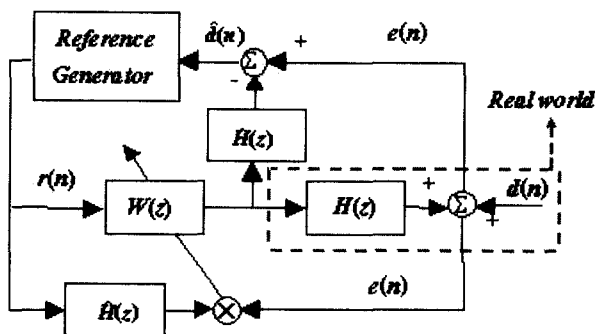

Fig. 7 Block diagram of ANC with reference generator

If the model of the cancellation path is exact, $\hat{d}(n)$ is equal to $d(n)$ and it becomes the harmonic input of the reference generator. Therefore, we estimate the fundamental frequency and generate the reference signal from an error signal via the IMC technique. In order to improve performance of the proposed method, we use a band-pass filter with a proper bandwidth in front of the harmonic input.

The method can also be used for vibration reduction.

4. Simulation Results

We simulated the proposed method for both the measured cabin noise of the passenger ship to verify its performance and the measured time-varying engine booming noise of the vehicle to verify the tracking capability. We used a constrained filtered- x LMS algorithm(8) as the feedforward control algorithm.

Figure 8 shows the steady-state power spectra of the cabin noise of a passenger ship before and after control. The periodogram of the noise is shown in Fig. 3 The step size of controller update was 0.04 and the tap of the controller filter was 70. The cancellation path H was modeled by an FIR filter with 6 step delay, i.e., [0, 0, 0, 0, 0, 0, 4, -3, 1, -1, 0.5, -0.1]. It is assumed that the cancellation path is exact. As shown in Fig. 8, five frequency components were reduced by about 10~15 dB.

Figure 9 shows the frequencies of the generated reference signal. Because the number of the dominant frequency components in range of the interested bandwidth 70 Hz~160 Hz is four, we estimated four frequencies($p=4$) and the fundamental frequency from them, and generated the reference signal which includes five frequency components ($l=5$) to be reduced. The estimated fundamental frequency was 15.3 Hz and the mode order was $m_k = [5, 6, 7, 9]$ and $m_{a,k} = [5, 6, 7, 8, 9]$. The frequency estimation was converged after 2850 step. The forgetting factor and the pole contraction factor were updated as follows:

$$\begin{aligned} \rho(n+1) &= 0.99\rho(n) + (1-0.99)0.99, \\ \lambda(n+1) &= 0.99\lambda(n) + (1-0.99)0.99, \end{aligned} \quad (11)$$

where both initial values were 0.85. As shown in Fig. 9, the proposed method was not affected by the beating

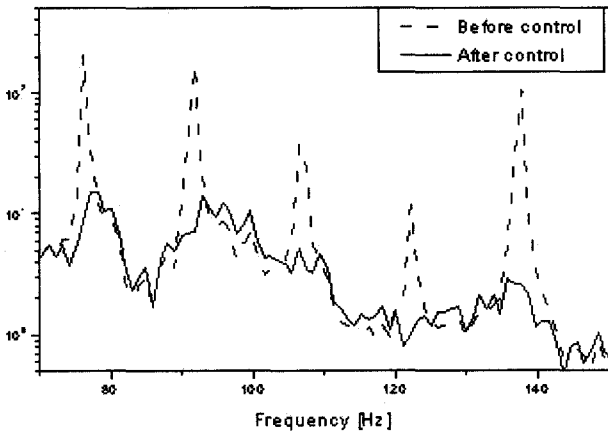

Fig. 8 Power spectra of the cabin noise of a passenger ship before and after control

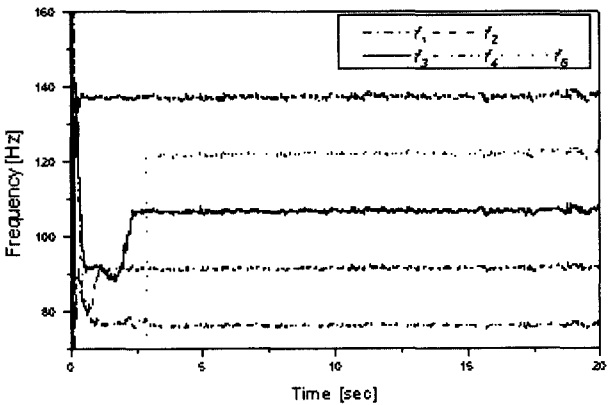

Fig. 9 Frequencies of the generated reference signal

phenomena, and the fundamental frequency was estimated properly.

Figure 10(a) and 10(b) show the waterfall of the measured engine booming noise before and after control, respectively. The step size of controller update was 0.3 and the tap of the adaptive filter was 50. The cancellation path H was equal to that of the cabin noise. As shown in Fig. 10(a) and Fig. 10(b), nine frequency components were reduced by about 5~15dB.

Figure 11 shows the frequencies of the generated reference signal. Because the number of the dominant frequency components in range of the bandwidth 10 Hz~450 Hz is two, we estimated two frequencies ($p=2$) and the fundamental frequency from them, and generated the reference signal which includes nine frequency components ($l=9$) to be reduced. The mode order was $m_k = [4, 8]$ and $m_{a,k} = [1, 2, 3, 4, 4.5, 5, 6, 7, 8]$.

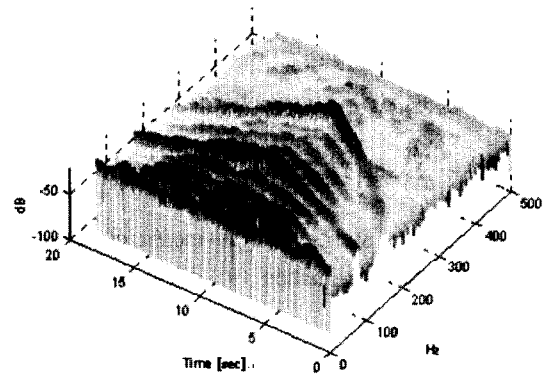

Fig. 10(a) Waterfall of the engine booming noise before control

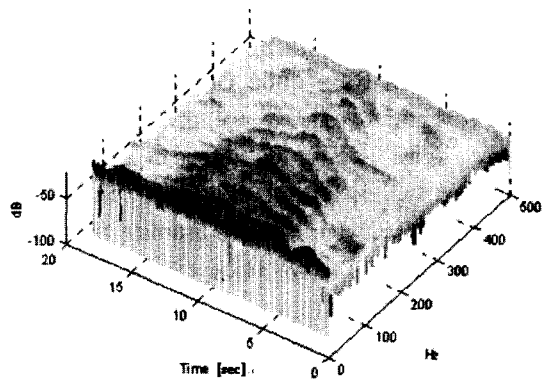

Fig. 10(b) Waterfall of the engine booming noise after control

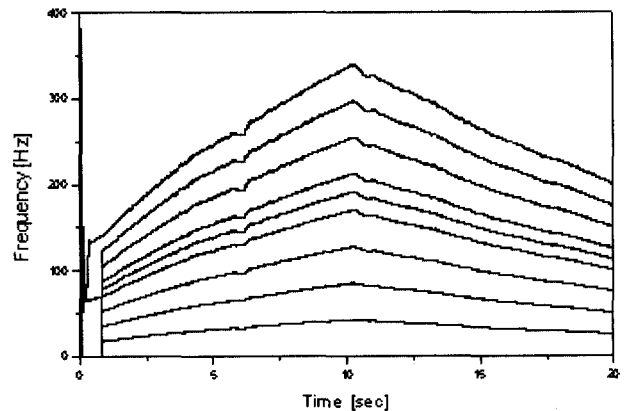

Fig. 11 Frequencies of the generated reference signal

The frequency estimation converged after 820 step. The forgetting factor and the pole contraction factor were updated as follows:

$$\begin{aligned} \rho(n+1) &= 0.99\rho(n) + (1-0.99)0.98, \\ \lambda(n+1) &= 0.99\lambda(n) + (1-0.99)0.98, \end{aligned} \quad (12)$$

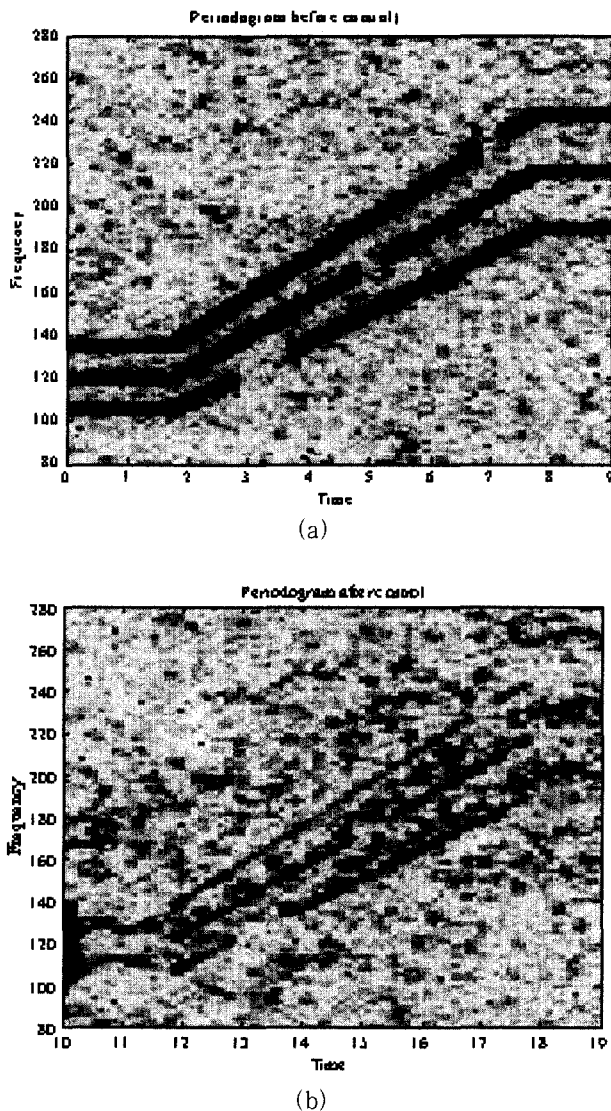

Fig. 12 Periodograms of time-varying signal with beating phenomena (a) before and (b) after control

where both initial values were 0.85. As shown in Fig. 11, the proposed method has the fast tracking capability.

Moreover, we simulated the method for the virtual time-varying signal with beating phenomena. It consists of 3 frequency components. The frequency-changing rate is 10 Hz/sec. Figure 12 shows the time-frequency plot of the signal before and after control. We observed that the proposed method performs satisfactorily even for a slowly time-varying system that shows beating phenomena.

5. Conclusions

We proposed an ANC scheme based on the fundamental frequency estimation for harmonic noise reduction. The proposed algorithm is composed of two parts. The first part is a reference generator using the estimated fundamental frequency, and the second one is the conventional feedforward control. The proposed indirect feedback ANC algorithm generates the reference signals, and embodies the feedforward configuration using them. We can obtain better performance than the conventional feedback ANC algorithm.

The proposed fundamental frequency estimation method using the decision rules was not influenced by the beating phenomena. In addition, it had good tracking capability and lower variance of frequency estimation error than that of the conventional cascade ANF method. We were also able to control every interested mode of the harmonic noise. We verified performance of the proposed ANC method through simulations for the measured cabin noise of a passenger ship and the measured time-varying engine booming noise of a vehicle.

References

- (1) Colin H. Hansen and Scott D. Snyder, 1997 Active Control of Noise and Vibration, 374~543. E & FN SPON.
- (2) Kuo S. M. and Vijayan D., 1994 Noise Control Eng. 42, 37~46. Adaptive Algorithms and Experimental Verification of Feedback Active Noise Control Systems.
- (3) Usagawa, T. Shimada Y. and Ebata, M. 1998 INTERNOISE 98, Adaptive Algorithm for Active Control of Periodic Noise with On-line Frequency Tracking.
- (4) Kim S. and Park Y., 1999 Journal of Sound and Vibration **227**(3), 647~666. Active Control of Multi-Tonal Noise with Reference Generator Based on On-line Frequency Estimation.
- (5) Kay S. M. and Marple, S. L., 1981 Proc. IEEE **69**, 1380~1419. Spectrum Analysis-A Modern Perspective.
- (6) Forsythe S. E., McCollum M. D. and McCleary A. D., 1991, Proc. Recent Advances in Active Control of Sound and Vibration, 879~889. Stabilization of a Digitally Controlled Active Isolation System.

(7) Burgess J. C., 1981, J. Acoust. Soc. Am. 70(3), 71 5~725, Active Adaptive Sound Control in a Duct : A Computer Simulation.

(8) Kim I.-S., Na H.-S., Kim K.-J., and Y. Park, 1994, J. Acoust. Soc. Am **95(6)**, 3376~3389, Constraint Filtered-x and Filtered-u Least Mean Square Algorithms for the Active Control of Noise in Ducts.

APPENDIX A. Averaging effect

Consider p_1 statistically independent random processes and their summed process as follows:

$$x_i(\mu_i, \sigma_i^2), \quad i=1, 2, \dots, p_1 \quad \text{and} \quad x_s = \frac{1}{p_1} \sum_{i=1}^{p_1} x_i. \quad (\text{A-1})$$

Then, the following properties are valid through simple derivation.

$$\mu_s = E[x_s] = \frac{1}{p_1} \sum_{i=1}^{p_1} \mu_i, \quad (\text{A-2})$$

$$\sigma_s^2 = E[(x_s - \mu_s)^2] = \frac{1}{p_1} \left(\frac{1}{p_1} \sum_{i=1}^{p_1} \sigma_i^2 \right). \quad (\text{A-3})$$

Variance of the summed signal theoretically decreases by about p_1 times compared with original signals.

APPENDIX B. Convergence Check Algorithm

$$\begin{aligned} \mu_{a,k}(n) &= s\mu_{a,k}(n-1) + (1-s)a_k(n), \\ \sigma_k(n) &= s\sigma_k(n-1) + (1-s)a_k(n)^2, \\ \text{var}_{a,k}(n) &= \sigma_k(n) - \mu_{a,k}(n)^2 \end{aligned} \quad (\text{B})$$

if $(\text{var}_{a,k}(n) < \text{MIN_VAR})$, then it converges.

For simulations of the cabin noise, MIN_VAR is 0.0003, and $s = e^{(-1/200)}$. For simulations of the engine booming noise, MIN_VAR is 0.003, and $s = e^{(-1/100)}$.