

**〈Technical Note〉**

**Establishment of the Procedure to Prevent Boron  
Precipitation During Post-LOCA Long  
Term Cooling for WH 3-Loop NPPs**

**H.R. Cho and S.K. Lee**

Korea Power Engineering Company, Inc.  
150 Dukjin-dong, Yusong-gu, Taejon 305-353, Korea

**C.H. Ban, and S.T. Hwang**

Korea Nuclear Fuel Company, Ltd.  
150 Dukjin-dong, Yusong-gu, Taejon 305-353, Korea

**B.H. Chang**

Junior College of Incheon  
235 Dohwa-dong, Nam-gu, Incheon 402-750, Korea

(Received February 22, 1996)

**Abstract**

Boric acid concentrations of the refueling water storage tank and the accumulators for Westinghouse 3-loop type plants are increased to meet the post loss of coolant accident shutdown requirement for the extended fuel cycles from 12 months to 18 months. To maintain long term cooling capability following a LOCA, the switchover time is examined using BORON code to prevent the boron precipitation in the reactor core with the increased boron concentrations. The analysis results show that hot leg recirculation switchover times are shortened to 7.5 hours from 24 hours after the initiation of LOCA for Kori 3&4 and 8 hours from 18 hours for Ulchin 1&2, respectively. The flow path in the mode J for Kori 3&4 is recommended to realign to the simultaneous recirculation of both hot and cold legs from the cold leg recirculation, as done by Ulchin 1&2.

**1. Introduction**

In Westinghouse 3-loop type plants [1][2], if the operating cycle is extended to 18 months, the RWST boron concentrations are increased to 2400-2600 ppm [3] from 2000-2250 ppm for

Kori 3&4 and to 2300-2500 ppm [4] from more than 2000 ppm for Ulchin 1&2 to support the fuel cycle. These changes will ensure that the core remains in a subcritical state during post-LOCA and refueling conditions for 18 month operating cycles [5]. However, the increase of RWST boron

concentration may cause the boron precipitation so that the LOCA acceptance criteria of 10CFR50.46 [6], "core remains amenable to cooling - coolable geometry", could be violated during post-LOCA long term cooling states.

Hot leg recirculation switchover time after initiation of the LOCA to prevent boron precipitation was given as approximately 24 hours in Kori 3&4 and approximately 18 hours in Ulchin 1&2. Due to the increased RWST boron concentrations the switchover time analyses were performed to determine the time when hot leg recirculation should be initiated following a hypothetical LOCA. These analyses address the concern of boron precipitation in the reactor vessel following a LOCA and support the increases of concentrations in the RWST and the accumulator. The analysis utilized the ABBCE LTC analysis methodology [7] and Westinghouse analyses [8][9]. BORON code is used in the calculation of the hot leg recirculation switchover time.

## **2. Description of the Emergency Core Cooling System**

### **2.1. Kori 3&4**

Kori 3&4 ECC system consists of the centrifugal charging (CHG) pumps, the boron injection tank (BIT), the refueling water storage tank (RWST), the residual heat removal (RHR) pumps, the accumulators and the associated valves, piping and instrumentations. The primary function of the ECCS following an accident is to remove the stored energy and fission product decay heat from the reactor core by replenishing system inventory such that fuel rod damage is prevented. The ECCS is designed to cool the reactor core, as well as to provide additional shutdown capability following

initiation of the accident conditions, which is the LOCA of primary system.

The ECCS components are designed such that a minimum of two accumulators, one charging pump, and one RHR pump, together with their associated valves and piping, will ensure adequate core cooling in the event of a design basis accident. The redundant onsite emergency diesels ensure adequate emergency power to all electrically operated components in the event that a loss of offsite power occurs simultaneously with an accident, even assuming a single failure in the emergency power system.

The major mechanical components of the ECCS are accumulators, BIT and surge tank, RHR pumps, centrifugal CHG pumps, boron injection recirculation pumps, residual heat exchangers, valves and RWST.

The accumulators are the pressure vessels partially filled with borated water and pressurized with nitrogen gas. During normal operations, each accumulator is isolated from the RCS by two check valves in series. Should the RCS pressure fall below the accumulator pressure, the check valves open and borated water is forced into the RCS. One accumulator is attached to each of the cold legs of the RCS. Liquid volume and concentration of the borated water in each accumulator required during normal plant operation are 28.31 m<sup>3</sup> and 1950 ppm, respectively.

The BIT contains a nominal 21000 ppm boric acid solution and is connected to the discharge of the charging pumps. Upon actuation by a safety (S) injection signal, the HHSI pump provides pressure to inject the boric acid solution into the RCS when the isolation valves associated with BIT open automatically. Usable volume at operating conditions (solution) of BIT is 3.4 m<sup>3</sup>.

The RHR pumps function as the low head safety

injection (LHSI) pumps. In the event of an accident the RHR pumps are started automatically on receipt of an S signal. They take suction from the RWST during the injection phase and from the containment sump during the recirculation phase.

The charging pumps function as the high head safety injection (HHSI) pumps. In the event of an accident, the charging pumps are started automatically on receipt of an S signal and are automatically aligned to take suction from the RWST during injection phase. During recirculation, suction is provided via the RHR pumps from containment sump. These pumps deliver flow to the RCS at the prevailing RCS pressure.

The residual heat exchangers (RHX) are conventional shell and u-tube type units. The RHR pumps supplies emergency core cooling water through the tube side while component cooling water flows through the shell side. During ECC recirculation operation, water from the containment sump flows through the tube side.

The refueling water storage system provides a source of borated water and it supplies the containment spray system (CSS) as well as the ECCS during the injection phase following a LOCA. The normal RWST capacity provides the minimum usable volume of 2044 m<sup>3</sup> for CSS and ECCS. The nominal concentration of boric acid solution in RWST is 2000 ppm.

The system liquid volume of RCS, including pressurizer water, is approximately 246.4 m<sup>3</sup>. The boric acid concentration of RCS is dependent on the burnup of plant specific cycle and is assumed as approximately 1700 ppm at begin of fuel life (BOL).

## 2.2. Ulchin 1&2

Ulchin 1&2 ECC system consists of the

HHSI/CHG pumps, the BIT, the RWST, the LHSI pumps, the accumulators, and the associated valves and piping. The primary function of the ECCS following an accident is same as that of Kori 3&4.

The ECC components are designed such that a minimum of two accumulators, one HHSI/CHG pump, and one LHSI pump together with their associated valves and piping will ensure adequate core cooling in the event of a design basis accident LOCA.

The accumulators are similar to those of Kori 3&4. Liquid volume and concentration of the borated water in each accumulator required during normal plant operation are 28.6 m<sup>3</sup> and more than 2000 ppm, respectively. The BIT is just same as that of Kori 3&4. Usable volume of boric acid solution at operating conditions of BIT is 3.4 m<sup>3</sup>.

In the event of LOCA the LHSI pumps are started automatically on receipt of an S signal. The LHSI pumps deliver water to the RCS and the HHSI pump suction from the RWST during the injection phase and from the containment sump during the recirculation phase.

In the event of an accident the HHSI/CHG pumps are started automatically on receipt of an S signal and are automatically aligned to take suction from the RWST via the LHSI pump. These pumps deliver flow through the BIT the RCS at the prevailing RCS pressure.

The refueling water storage system is same as that of Kori 3&4. The normal RWST capacity provides the minimum usable volume of 1692 m<sup>3</sup> for CSS and ECCS. The nominal concentration of boric acid solution in RWST is more than 2000 ppm.

The system liquid volume of RCS, including pressurizer water, is approximately 272 m<sup>3</sup>. The boric acid concentration of RCS is assumed as approximately 1700 ppm at BOL.

### 3. ECCS Operating Procedure During LOCA and Post-LOCA

A LOCA is defined as a rupture of the RCS piping or branch piping which results in a decrease in RCS inventory that exceeds the flow capability of the normal makeup system. The spectrum of postulated piping breaks in the RCS is divided into major pipe breaks (large break) and minor pipe breaks (small break).

#### 3.1. Kori 3&4

For the accident, the ECCS is actuated upon receipt of an S signal. Once actuated the ECCS will mitigate the spectrum of LOCA accidents but its performance will vary, depending on the LOCA transient. The HHSI pumps function to immediately inject high concentration boric acid solution from the BIT followed by the injection of lower concentration borated water from the RWST. The LHSI pumps function to start delivering borated water from the RWST when the RCS depressurizes to approximately 13.8 bar. The accumulators begin to inject when the RCS depressurizes to approximately 41.4 bar. During the LOCA transient, flow to the RCS is dependent on the RCS pressure transient. The ECCS water injected into the RCS provides for heat transfer from the core, prevents excessive fuel clad temperatures and eventually accomplishes core reflood (large break) or core recovery (small break). The thermal-hydraulic LOCA analyses do not take credit for the boron content of the injected water.

Following the completion of core reflood or core recovery, the ECCS continues to supply water to the RCS for the long term cooling. After the water level in the RWST reaches the low-low level setpoint, switchover to cold leg recirculation is initiated automatically and completed by manual operator action. This permits continued cooling of

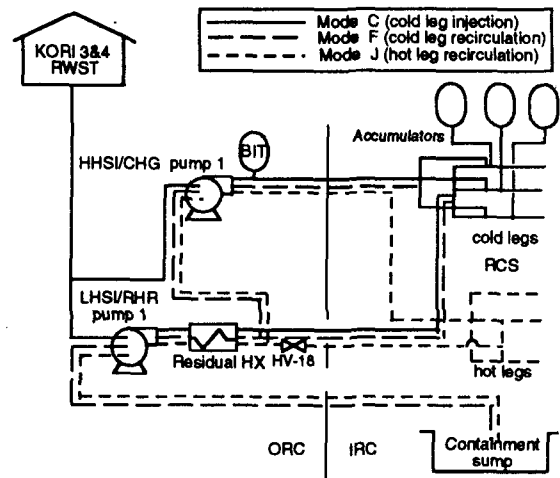
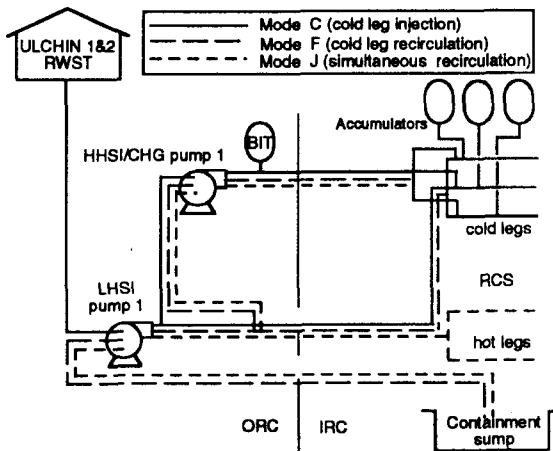

Fig. 1. ECCS Overall Process Flow Diagram for Kori 3&4 (Train A Operating)

the core by the recirculation of the spilled water in the containment sumps. At approximately 24 hours after the initiation of the LOCA, the ECCS is manually realigned to the hot leg recirculation mode to control boric acid concentration in the reactor vessel. The ECCS overall process flow diagram scheme is presented in Fig. 1.

The operations are typically divided into 3 modes in minimum safeguards (train A or B operating). Mode C of cold leg injection/minimum safeguards represents the case of minimum safeguards with LHSI pump 1 and HHSI pump 1 taking suction from the RWST and delivering to the reactor through three cold leg connections (solid line in Fig. 1).

Mode F of cold leg recirculation/minimum safeguards represents the case of cold leg recirculation with LHSI pump 1 and HHSI pump 1 operating. In this mode the safeguards pumps operate in series with only LHSI pump 1 capable of taking suction from the containment sump. The recirculated coolant is then delivered by LHSI pump 1 to HHSI pump 1, which delivers coolant to the reactor through three cold leg connections.



**Fig. 2. ECCS Overall Process Flow Diagram for Ulchin 1&2 (Train A Operating)**

The LHSI pump may also deliver flow directly to the reactor through the same three cold leg connections (long dashed line in Fig. 1).

Mode J of hot leg recirculation/minimum safeguards represents the case of hot leg recirculation with LHSI pump 1 and HHSI pump 1 operating. In this mode the safeguards pumps again operate in series with only LHSI pump 1 taking suction from the containment sump. The recirculated coolant is then delivered by LHSI pump 1 to HHSI pump 1, which delivers coolant to the reactor through three hot leg connections. The LHSI pump may also deliver flow directly to the reactor through two hot leg connections (short dashed line in Fig. 1).

### 3.2. Ulchin 1&2

For the LOCA, the ECCS is actuated as similar to that of Kori 3&4. At approximately 18 hours after the initiation of the LOCA, the ECCS is manually realigned to the hot leg recirculation mode to control boric acid concentration in the reactor vessel. The safety injection system overall

process flow diagram scheme is presented in Fig. 2.

The operations are typically divided into 3 modes in minimum safeguards (train A or B operating). Mode C of cold leg injection/minimum safeguards represents the case of minimum safeguards with LHSI pump 1 and HHSI pump 1 taking suction from the RWST and delivering to the reactor through three cold leg connections. LHSI pump 1 boosts HHSI pump 1 (solid line in Fig. 2).

Mode F of cold leg recirculation/minimum safeguards is just the same as that of Kori 3&4 (long dashed line in Fig. 2).

Mode J of simultaneous recirculation/minimum safeguards represents the case of hot leg and cold leg simultaneous recirculation with LHSI pump 1 and HHSI pump 1 operating. In this mode the safeguards pumps again operate in series with only LHSI pump 1 taking suction from the containment sump. The recirculated coolant is then delivered by LHSI pump 1 to HHSI pump 1, which delivers coolant to the reactor through three cold leg connections. The LHSI pump also delivers directly to the reactor through two hot leg connections (short dashed line in Fig. 2).

## 4. Methodology of the LTC Analysis

The objective of the LTC analysis is to demonstrate that the LTC capability of the core is maintained following a LOCA. The methodology incorporated in the analysis refers to the ABBCE LTC methodology [7] and to the initial and boundary conditions in references [8][9].

BORON code is applied in calculating the boron precipitation time. The basic equation sets of the code calculate the time-dependent boron concentration in the system from the initial liquid and boron distributions in the system and the safety injection flow. The core boiloff rate and hot leg entrainment are calculated by the code and the

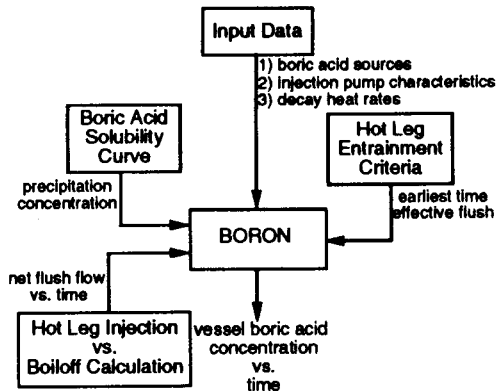
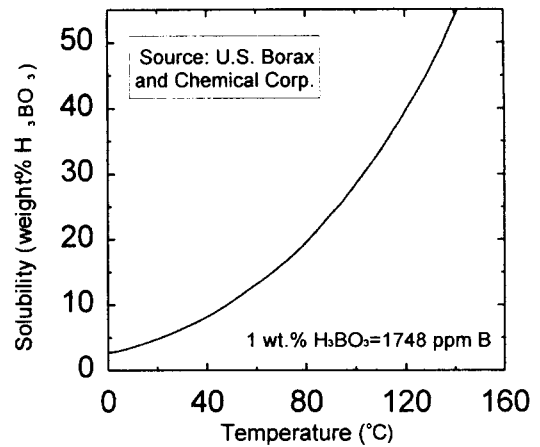

**Fig. 3. Long Term Cooling Large Break LOCA Analysis Procedure**

resulting boron precipitation is calculated using the boric acid solubility limit. Even if the BORON code is originally developed for application to ABBCE type plants, the basic models and correlations in the code are quite general for application to typical PWR design. Thus, the code may be applied for Westinghouse Kori 3&4 and Framatom Ulchin 1&2 PWRs.

The LTC analysis is performed for the time following a large break LOCA when the core has been recovered and cooled by water from the safety injection system. The effect of break location may be considered in the long term cooling for boric acid precipitation.

For large cold leg break, following the reflood, the cold side safety injection water will be accumulated to the level of the cold leg break. Additional water will spill through the break. Steam generated in the core is accumulated in the upper plenum, which increases the core pressure. Thus the driving force to flush the core is weakened and the core boils off to remove core decay heat. Boric acid will be left in the vessel and its concentration will be increased. Therefore it should be switched from cold leg safety injection



**Fig. 4. Solubility of Boric Acid in Water vs. Temperature**

water to hot leg, before reaching the solubility limit of boric acid due to the increased boron concentration in the vessel. Safety injection water of the hot leg that comes from sump will be injected directly to upper plenum. Thus the driving force to flush the core is increased again and boiloff of the core will be terminated.

For large hot leg break, following the reflood, the cold side safety injection water will develop a sufficient elevation head to provide a liquid flush through the vessel and out of the break. The elevation head will be augmented by liquid backup into the cold side of the steam generators. As a consequence, core flow develops to high upward flows. Boric acid will be removed and its concentration in the vessel will not be increased as much as in the case of cold leg break. However, the cold side safety injection water will be switched to the hot side with a time of switchover according to only emergency operating procedures. Thus hot side safety injection water is injected to upper plenum directly. As a result, hot side safety injection water of the intact loops may be bypassed to containment through the break of the

hot leg. If this transient behavior is kept for long time without any actions, boric acid will be left again in the vessel and its concentration may be increased again.

Consequently, the enough and effective core flushing flow should be supported in order to preclude boron precipitation for either hot leg or cold leg break.

The LTC methodology follows the procedures as below and in Fig.3.

- 1) The minimum saturation temperature of the RCS is determined by a transient containment pressure analysis. The RCS temperature is that corresponds to the minimum saturation pressure reached in the containment during the time period of interest.
- 2) The boric acid precipitation concentration for the established minimum RCS temperature is determined from the boric acid solubility curve (see Fig.4).
- 3) The minimum time for the RCS boron concentration to reach the established precipitation level without flushing is determined by the code. This time is  $t_{\text{precipitation}}$ .
- 4) The maximum time to achieve effective hot leg flushing is determined as the time when hot leg steam flow falls below that flow which can entrain inject water, according to the Wallis criteria [10]. This time is  $t_{\text{flush}}$ .
- 5) Then  $t_{\text{flush}}$  and  $t_{\text{precipitation}}$  are compared to assure that  $t_{\text{flush}} < t_{\text{precipitation}}$ .
- 6) Next, the core boiloff rate and the hot leg and/or cold leg injection flow at  $t_{\text{flush}}$  are calculated. These are termed, respectively,  $W_{\text{boiloff}}$  and  $W_{\text{injection}}$ .
- 7) The minimum net flushing flow required at  $t_{\text{flush}}$  to prevent the boric acid accumulation is then calculated by the BORON code. This flushing is  $W_{\text{flush}}$ .
- 8) Finally, these various flows are compared to assure that  $W_{\text{injection}} - W_{\text{boiloff}} > W_{\text{flush}}$ .

## 5. Analysis Results

The post-LOCA LTC analysis uses conservative assumptions which yield the most unfavorable predictions of system performance. These results, therefore, demonstrate the most limiting LTC plan for LOCAs and ensure adherence to the licensing criteria for LTC given in 10CFR50.46. Major assumptions for the analysis are listed as follows:

- 1) Initial power level is 102 % of nominal full power.
  - 2) One train is operating (HHSI pump 1 and LHSI pump 1).
  - 3) The RCS is conservatively assumed to be maintained at the saturated condition of 1.0 bar and 100°C which is based on a conservative ECCS model for containment backpressure. These saturation conditions permit the maximum boric acid concentration limit of 27.53 w/o to avoid the boron precipitation (see Fig.4).
  - 4) The Wallis criteria is used to determine the time at which hot leg steam flow will no longer entrain water.
  - 5) The maximum boric acid source concentrations are used. These sources include RCS, RWST, accumulators and BIT.
  - 6) Following a LOCA, the steam boiloff from the core does not carry any boron. Volume of liquid in the vessel is constant after reflooding. As steam is boiled off, boron is left behind and the boric acid concentration of the vessel increases.
  - 7) Small effective vessel volume includes only the free volumes of the reactor core and upper plenum below the bottom of the hot leg nozzles.
- Using these assumptions, BORON code is applied for Kori 3&4 and Ulchin 1&2 LTC analyses.

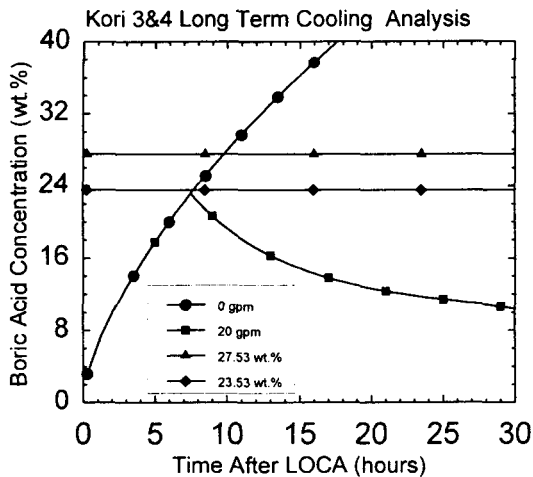

Fig. 5. Boric Acid Concentration of the Reactor Vessel vs. Time for Kori 3 & 4

### 5.1. Kori 3 & 4

Kori 3&4 RTSR [11] shows that containment pressure is asymptotically approaching to 1.36 bar during LTC phase, however, it is conservatively assumed to be 1.0 bar.

It is necessary to determine the earliest time at which the boric acid concentration in core reaches the solubility limit when no core flush is provided to the core. The solubility limit applied in the analysis is 23.53 w/o, which is less than the theoretical limit of 27.53 w/o at 100°C by 4 w/o for uncertainty consideration. The analysis has been performed to determine this time following a LOCA when the switchover to hot leg recirculation should be initiated to prevent boron precipitation in the reactor vessel. The time is calculated to be 7.5 hours [ $t_{\text{precipitation}}$ ].

From the Wallis criteria, the time at which all the hot leg steam entrainment of inject water terminates is calculated 2.5 hours after the LOCA [ $t_{\text{flush}}$ ]. Therefore, the hot leg switchover at 7.5 hours after LOCA can exclude any potential for hot leg entrainment.

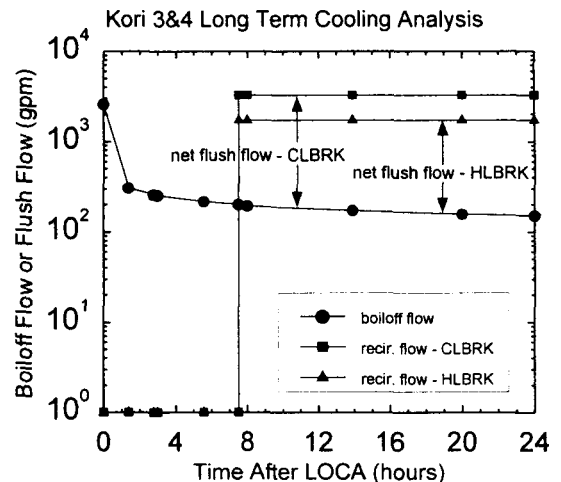
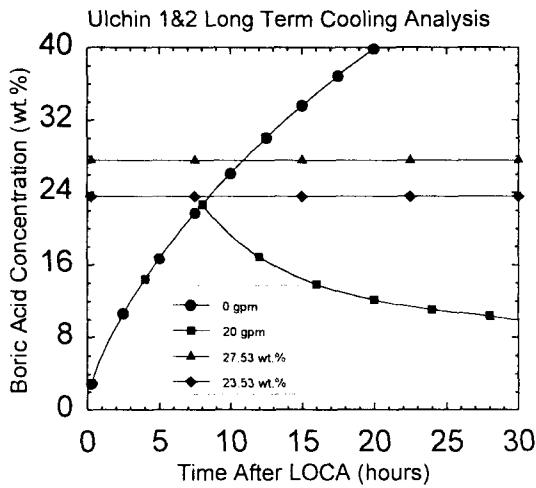

Fig. 6. Core Flush Flows of Cold Leg and Hot Leg Break for Kori 3 & 4

Fig.5 represents the calculated boron concentration in vessel without hot leg switchover (no core flush) and with hot leg switchover (core flush) having 20 gpm of the assumed hot leg recirculation flow. The boric acid concentration decreases rapidly even with the constant flush flow of 20 gpm which is quite lower than the ECCS flows designed for each mode of injection and recirculation. From the results, it is concluded that the boron precipitation does not occur even without core flush - still in cold leg injection (mode C) and cold leg recirculation (mode F) - during 7.5 hours after LOCA. However, the operators should changeover the ECCS operation mode from the cold leg recirculation to the hot leg recirculation (mode J) to prevent the reactor vessel from the boron precipitation at 7.5 hours after LOCA [12].

For large cold leg break, considering that the net core flush flow (about 3100 gpm) is quite higher than the flow assumed in the analysis (20 gpm), the boron concentration in vessel after switchover to hot leg recirculation will be decreased faster. For large hot leg break, even if the net core flush flow (about 1600 gpm) is about half of that for cold leg break, still is very higher than the flow



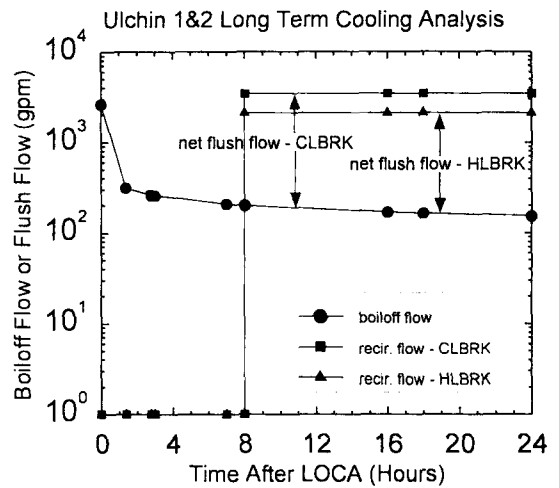

**Fig. 7. Boric Acid Concentration of the Reactor Vessel vs. Time for Ulchin 1&2**

assumed in the analysis. The net core flush flows are shown in Fig.6 for cold leg break and hot leg break, respectively.

Meanwhile, valve of HV-18 in discharge line of LHSI pump is located in the outside of reactor containment as shown in Fig.1, which is always closed at mode C and F for hot leg recirculation. If this valve is failed in the event of mode J of the hot leg recirculation, the LHSI flow does not contribute to prevent boron precipitation. The HHSI flows (612 gpm for cold leg break and 408 gpm for hot leg break) of hot leg recirculation, however, are injected to hot legs and are still higher than 20 gpm even if the flows are far less than those of no failure of the valve.

As a result, although boron precipitation does not happen with less flow of hot leg recirculation as shown in Fig.5, it is necessary to establish adequately the procedures of valves and piping alignment to guarantee flow path depending on valve failure in order not to have the possibility of the boron concentration increasing at all due to bypass of hot leg recirculation flow. That is, if valve is operable normally, there is no problem since more flow is injected directly to the upper



**Fig. 8. Core Flush Flows of Cold Leg and Hot Leg Break for Ulchin 1&2**

plenum. However, if valve is inoperable, the hot leg recirculation of LHSI flow is to realign to the RCS cold legs from hot legs, while the HHSI flow is still aligned to the RCS hot legs in the mode J. These complicated switchover actions to get flow paths with several valves and piping are a heavy burden on operator for knowledge of the break location and valves malfunction. Therefore, regardless of break location and valve failure, the simultaneous hot leg and cold leg recirculation will be recommended in the mode J.

As a consequence, the maximum allowable boron concentration of 23.53 w/o will not be exceeded in the vessel if hot leg recirculation is initiated at 7.5 hours after the LOCA inception, thus to prevent the boron precipitation and to maintain the coolable geometry.

### 5.2. Ulchin 1&2

Ulchin 1&2 RTSR [13] shows that containment pressure is asymptotically approaching to 1.36 bar during LTC phase, however, it is conservatively assumed to be 1.0 bar.

The procedures of analysis for Ulchin 1&2 is

carried out as Kori 3&4. The times of  $t_{\text{precipitation}}$  and  $t_{\text{flush}}$  are calculated to be 8 hours and to be 2.5 hours with the Wallis criteria.

Fig.7 represents the calculated boron concentration in vessel as Kori 3&4. It is concluded that the boron precipitation does not occur even without core flush - still in cold leg injection (mode C) and cold leg recirculation (mode F) during 8 hours after LOCA initiation. However, the operators should changeover the ECCS operation mode from the cold leg recirculation to the hot leg and cold leg recirculation simultaneous recirculation mode (mode J) to prevent the reactor vessel from the boron precipitation at approximately 8 hours after LOCA [14].

Considering that the net core flush flows of Ulchin 1&2 (about 3250 gpm for cold leg break and about 1900 gpm for hot leg break with minimum safeguards assumption) are quite higher than the flow assumed in the analysis (20 gpm), the boron concentration in vessel after switchover to hot leg recirculation will be decreased faster. The net core flush flows of Ulchin 1&2 are shown in Fig.8 for cold leg break and hot leg break, respectively.

Ulchin 1&2 is slightly different from Kori 3&4 in ECC system. There are no residual heat exchanger and valve for hot leg recirculation in the LHSI pump discharge line to RCS hot leg in Ulchin 1&2, while capacities of the LHSI and the HHSI pumps are greater than those of Kori 3&4. As a result, it is not necessary to consider the valves and piping alignments to get flushing flow paths with regard to break location since mode J is simultaneous hot leg and cold leg recirculation.

As a consequence, if simultaneous hot leg and cold leg recirculation is initiated at 8 hours after the LOCA inception, the boron precipitation is precluded and the coolable geometry is maintained.

## 6. Conclusions

Boric acid concentrations of the RWST and accumulators are increased in order to maintain the post-LOCA shutdown requirements due to the extended operating fuel cycle for Westinghouse 3-loop type plants. The analyses are performed for the possibility of boron precipitation during a post-LOCA long term cooling since boric acid concentration increased. From the analysis results, it is concluded as follows;

### for Kori 3&4

- 1) the switchover time of hot leg recirculation should be shortened to be approximately 7.5 hours after the LOCA inception from approximately 24 hours.
- 2) In the mode J, hot leg recirculation is recommended to simultaneous hot leg and cold leg recirculation.

### for Ulchin 1&2

- 3) The switchover time of simultaneous hot leg and cold leg recirculation should be shortened to be approximately 8 hours after a LOCA inception from approximately 18 hours.

## References

1. KEPCO, Final Safety Analysis Report for Kori 3&4 Nuclear Power Plants.
2. KEPCO, Final Safety Analysis Report for Ulchin 1&2 Nuclear Power Plants.
3. J.W. Song, Evaluation of core boron concentration to maintain core coolability during post-LOCA LTC for 900MWe NPPS, TR-ND-GEN-93002 Rev.0, April 12, (1993)
4. J.H. Kim, Evaluation of core boron concentration to maintain core coolability during post-LOCA LTC for Ulchin2 cycle 7, TR-ND-UC207-95001 Rev. 0, September 13, (1995)

5. H.R. Choi, Development of calculation method for post-LOCA RCS/Sump mixed mean boron concentration dependent on RWST boron concentration, CA-AA-UC207-95032 Rev. 0, Sep. 7, (1995)
6. USNRC, 10CFR50.46, Acceptance Criteria for Emergency Core Cooling System for Light Water Nuclear Power Reactor.
7. ABBCE Power Systems, Post-LOCA Long Term Cooling Evaluation Model, CENPD-254-P-A.
8. Letter to Mr. Harold R. Denton/USNRC, Serial No.86-690, Virginia Electric and Power Company - North Anna Power Station Units No.1&2 - Proposed Technical Specification Change Boron Concentration Increase, December 22, (1986)
9. Letter to USNRC, Serial No.86-690, Virginia Electric and Power Company - Surry Power Station Units No.1&2 - Proposed Technical Specification Change Boron Concentration Increase, December 21, (1990)
10. G.B.Wallis, One-Dimensional Two-Phase Flow, McGraw-Hill, 1969, p.393.
11. Siemens AG, KWU-Group, KAERI, Reload Transition Safety Report for Kori Nuclear Power Plant Unit 3&4, June (1988)
12. H.R.Choi, An Analysis of Hot Leg Recirculation Switchover Time to Prevent Boron Precipitation for Kori 3&4, TR-AA-KR8-92012E,Rev.1, April 30, (1993)
13. Siemens AG, KWU-Group, KAERI, Reload Transition Safety Report for ULCHIN Nuclear Power Plant Unit 1&2, June (1988)
14. H.R.Choi, Determination of Hot Leg Recirculation Switchover Time to Prevent Boron Precipitation for Ulchin 1&2, CA-AA-UC207-95035 Rev.1, Jan.12, (1996)