

Helium-Air Exchange Flows Through Partitioned Opening and Two-Opening

Tae-il Kang

Chang Shin College

541 Bongam-Dong, Masan 630-764, Korea

(Received October 2, 1996)

Abstract

This paper describes experimental investigations of helium-air exchange flows through partitioned opening and two-opening. Such exchange flows may occur following rupture accident of stand pipe in high temperature engineering test reactor. A test vessel with the two types of small opening on top of test cylinder is used for experiments. An estimation method of mass increment is developed to measure the exchange flow rate. Upward flow of the helium and downward flow of the air in partitioned opening system interact out of entrance and exit of the opening. Therefore, an experiment with two-opening system is made to investigate effect of the fluids interaction of partitioned opening system. As a result of comparison of the exchange flow rates between two types of the opening system, it is demonstrated that the exchange flow rate of the two-opening system is larger than that of the partitioned opening system because of absence of the effect of fluids interaction.

1. Introduction

A high temperature engineering test reactor (HTTR) is now being constructed in Japan Atomic Energy Research Institute (JAERI) to establish and upgrade high temperature gas cooled reactor (HTGR) technologies [1]. In safety study of the HTTR, a rupture of stand pipes at top of the reactor vessel is considered as one of the most critical design-base accidents [1]. Figure 1 shows a schematic drawing of the HTTR and the HTTR is a graphite moderated high temperature gas-cooled reactor of 30 MW thermal power and 950 °C outlet helium coolant temperature. When stand pipes rupture, helium coolant gas in high pressure flows immediately through breach out of the reactor vessel. After the pressure in the reactor vessel has fallen to that of the atmosphere, the

air flows into the reactor vessel, which is caused by buoyancy force due to density difference between the helium inside the reactor vessel and the air outside. The penetrated air reacts with high temperature graphite structure, and causes corrosion of the graphite components, which results in a severe damage of in-core reactor structures. Therefore, an estimation of magnitude of the buoyancy-driven exchange flow through the stand pipe is necessary to assess the air flow into the reactor vessel.

From a survey of the literature, it appeared that some papers dealt with buoyancy-driven exchange flow with brine-water [2, 3, 4, 5] and air-air [6, 7]. Epstein [2] made measurements of the buoyancy-driven exchange flow with a single opening, for opening ratios H_1/D_1 in the range 0.01 to 10, where H_1 and D_1 are height of the opening and inner diameter of the

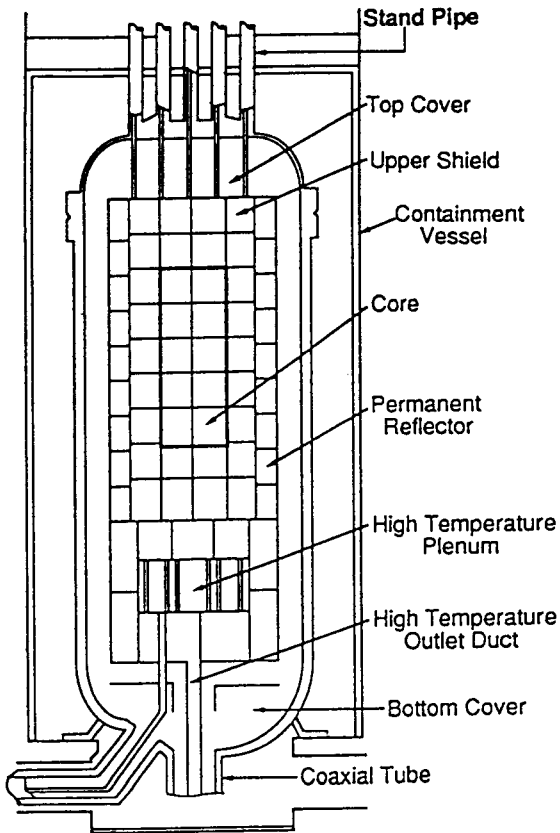

Fig. 1. Schematic Diagram of HTTR's Arrangement[1]

opening, respectively. He suggested four different flow regimes shown in Fig. 2, as H_1/D_1 increased through this range. As a result of these measurements, he found a peak value of the exchange flow rate at H_1/D_1 of about 0.5 as shown in Fig. 2. Most of the above studies on the buoyancy-driven exchange flow have been carried out with a single opening and small density difference. However, the density of cold air outside reactor vessel is at least three times larger than that of gas mixture (helium and hot air) inside the reactor vessel at the stand pipe rupture accident. Fumizawa [8] conducted experiments for the Epstein's experimental conditions with the helium-air and the single opening. He reported that the experimental results for the helium-air system agreed with those for the Epstein's brine-water system as shown

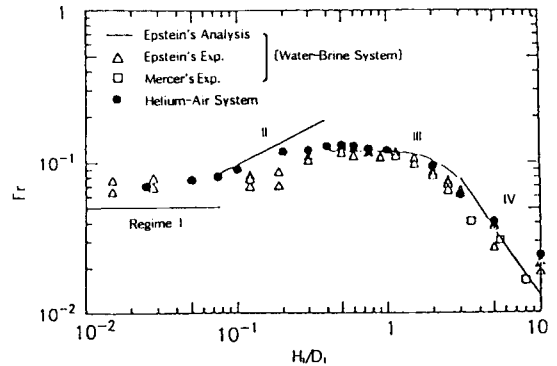

Fig. 2. Comparison of Measured Froude Numbers between Helium-Air System and Brine-Water System[8]

in Fig. 2. In Epstein's paper [2], he also made experiments with two openings. His experimental purpose was to investigate flow patterns of the two-opening system, and the two openings were observed to give rise to three different flow configurations. There were no studies for the exchange flow through partitioned opening (opening with a vertical partition) in the previous studies. Kang et al. [9] performed experiments on the helium-air exchange flow with the partitioned opening and the single opening for opening ratios H_1/D_1 in the range 0.05 to 10. In the previous study [9], the single opening was used to model the rupture of single stand pipe and the partitioned opening was used to model the rupture of two stand pipes. From a fundamental point of view, there is a big difference of flow passages between the two types of opening. Thus, it is necessary to compare exchange flow rate and flow pattern. At lower opening ratios ($H_1/D_1 < 0.75$), the exchange flow rates for the partitioned opening were almost the same as those for the single opening. However, at higher opening ratios ($H_1/D_1 \geq 0.75$), they were larger than those for the single opening, because upward flow of the helium and downward flow of the air were separated by the vertical partition within the opening. Effect of the various inner diameters of the opening on the exchange flow rate was investigated at higher open-

ing ratios [10]. The inner diameters of the opening were 0.01, 0.02, and 0.04 m, and the opening ratios were in the range 0.6 to 10. The exchange flow rates increased with increasing the inner diameter. Based on his flow visualizations [9, 10], he pointed out the effect of fluids interaction between the air and the helium out of entrance and exit of the partitioned opening. Therefore, an experiment with two-opening system is performed to investigate the fluids interaction of the partitioned opening system on the exchange flow in the present study.

2. Experimental Apparatus and Procedures

Figure 3 illustrates an experimental apparatus to evaluate the exchange flow rate for the partitioned opening system and two-opening system. Essential features of the experimental apparatus are described with aid of Fig. 3. The experimental apparatus is composed of a test vessel, an electronic balance, and a personal computer for data acquisition. The test vessel consists of a test cylinder and opening made from plexiglass. Two types of the opening were employed in the experiments, i.e., the partitioned opening and the two-opening. The opening configurations studied are presented in Fig. 4 and Fig. 5. A vertical partition of rectangular plate is in alignment

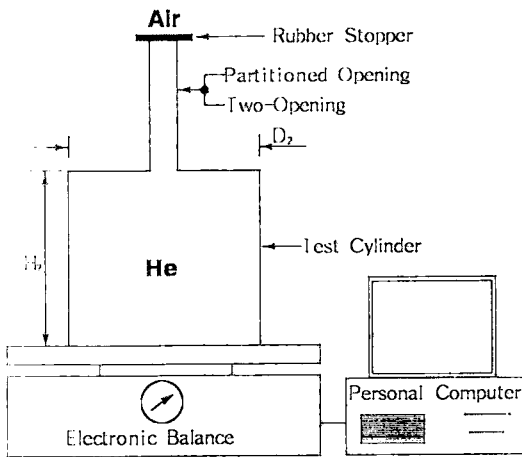

Fig. 3. Schematic Diagram of Experimental Apparatus

with center line of the opening to make the partitioned opening as shown in Fig. 4, where partition thickness δ is 0.0005 m. Figure 5 shows a test section for investigating the effect of fluids interaction of the partitioned opening system on the exchange flow rate. Each opening is separated by the vertical partition. A distance (0.1 m) between the two openings is long enough to remove the fluids interaction between the upward flow of the helium and downward flow of the air. One side of each opening is closed to avoid the fluids interaction. The diameters and heights of the openings and the test cylinders are tabulat-

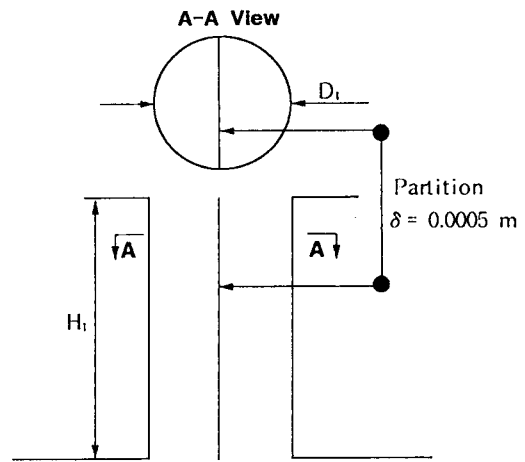

Fig. 4. Schematic Diagram of Partitioned Opening

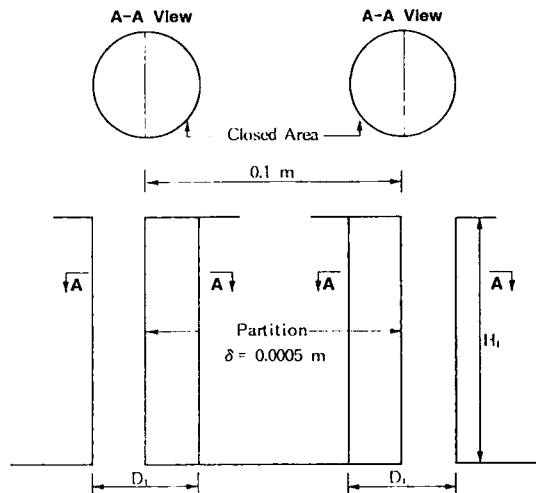
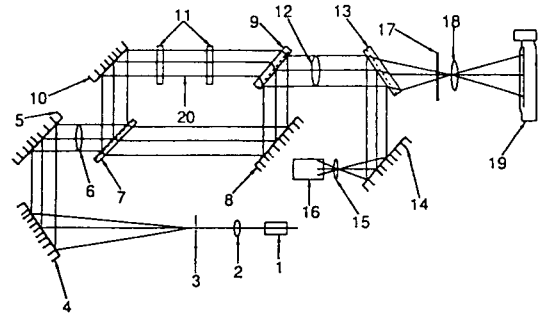

Fig. 5. Schematic Diagram of Two-Opening

Table 1. Test Vessel Geometry

Opening Type	D ₁ m	H ₁ m	D ₂ m	H ₂ m
Partitioned Opening	0.01	0.1	0.1	0.2
Two-Opening	0.01	0.1	0.194	0.4

ed in Table 1. The experiments were carried out under the atmospheric pressure and room temperature. The test vessel was filled with pure helium gas initially. The opening's top was sealed with a thin rubber stopper as shown in Fig. 3. On removal of rubber stopper placed on the top of the opening, the buoyancy-driven exchange flow was initiated and the heavier air was introduced into the test vessel. Thus, the mass of gas mixture in the test vessel increased. Figure 6 shows optical components of Mach-Zehnder interferometer to visualize the exchange flow. Illumination beam (He-Ne laser supplied from light source, wave length 633 nm) collimated by lens 2 is split by beam splitter 1 inclined at 45° into a test beam and a reference beam. The test beam reflected by coated surface of the beam splitter 1 is reflected by mirror 4 in order to cross the test section closed by windows. The beam is then transmitted through the beam splitter 2, forming a test section image on observation screen. At the same time, the reference beam transmitted through the beam splitter 1 is successively reflected by mirror 3 and coated surface splitter 2 before being superimposed on the test beam. The beam splitter 2 imposes the same optical path delay on the test beam that the beam splitter 1 does on the reference one. Consequently, the test beam and the reference beam are mixed beyond the beam splitter 2. The test beam and the reference beam interfere, and interference fringe pattern appears on the screen. If density of the test section is homogeneous, straight parallel equidistant interference fringes appear [11]. If it is inhomogeneous, distorted interference fringes appear. The experimental procedure of two-opening system was essentially the same as

**Fig. 6. Optical Components of Mach-Zehnder Interferometer**

- | | | | |
|----------------|--------------|-----------------|------------------|
| 1. Laser | 2. Lens 1 | 3. Pinhole | 4. Mirror 1 |
| 5. Mirror 2 | 6. Lens 2 | 7. Splitter 1 | 8. Mirror 3 |
| 9. Splitter 2 | 10. Mirror 4 | 11. Window | 12. Lens 3 |
| 13. Splitter 3 | 14. Mirror 5 | 15. Lens 4 | 15. CCD Camera |
| 16. Screen | 18. Lens 5 | 19. 35mm Camera | 20. Test Section |

that described in the foregoing for the partitioned opening system, except that the two rubber stoppers were placed, one in each opening. Three programs, i.e., program for measuring mass increment, program for calculation of density increment, and program for calculation of measured Froude number are used for data processing in the present experiment. The flow was initiated by removing each stopper simultaneously. The mass increment Δm_t of the gas mixture was measured by means of the electronic balance at regular intervals.

$$\Delta m_t = m_{L_t} - m_{H_0} \quad (1)$$

The gas mixture's density increment $\Delta \rho_L$ is calculated from the mass increment, and it is given by,

$$\Delta \rho_L = \frac{\Delta m_t}{V} \quad (2)$$

where V is volume of the test vessel. The volume exchange flow rate Q is evaluated by the measured density increment. Mass balance on the gas mixture gives

$$V \frac{d\Delta \rho_L}{dt} = Q \rho_H - Q \rho_L \quad (3)$$

The volume exchange flow rate is expressed in the form of Froude number Fr , and it is defined as

$$Fr = Q \sqrt{\frac{\rho_m}{D_f^5 g (\rho_H - \rho_L)}} \quad (4)$$

In the present experiment, the effective diameter D_f is used in Eq. (4) because the openings are not round. It is given by

$$D_f = \sqrt{\frac{4}{\pi} \left(\frac{\pi D_1^2}{4} - D_1 \delta \right)} \quad (5)$$

3. Results and Discussion

Figure 7 illustrates variation of the density increment with time, and the inner diameter of the opening is 0.01 m. The density increment for the both opening systems increases with the time. As expressed in Eq. (2), the density increment of the gas mixture in the test vessel increases due to the exchange flow. Finally, it approaches the density difference between the air and the helium. The density increment of the partitioned opening system is larger than that of the two-opening system because the volume of the test vessel with partitioned opening is smaller than that of the test vessel with the two-opening as shown in Table 1. Figure 8 shows variation of the measured Froude number with the time. The measured Froude number of the two-opening system is almost constant with the time because it is thought that buoyancy force, i.e., the density difference between the air and the gas mixture is almost constant. The measured Froude number of the partitioned opening system appears to be constant value before about 200 second. They fluctuate after about 200 second and thus, these measured data are not sufficient to explain trend of the exchange flow rate. Figure 9 is prepared to illustrate the comparison of relationship between the measured Froude number and the density increment. Figure 9 shows that difference in the measured Froude numbers between the two types of opening system is caused by the effect of fluids interaction and this effect is supported by the flow visualization. This figure shows the varia-

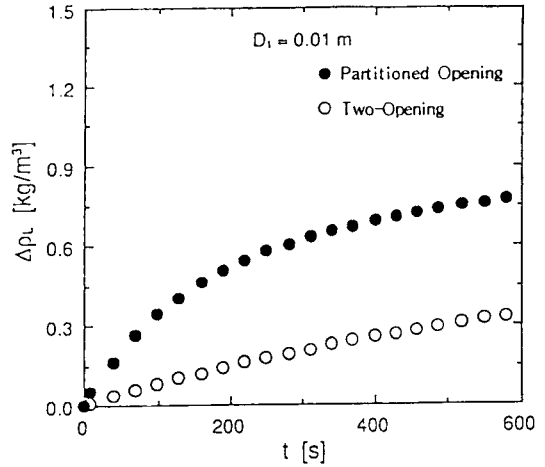

Fig. 7. Variation of Density Increment with Time

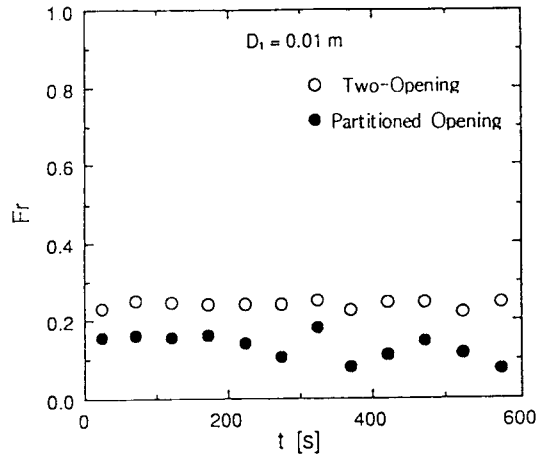

Fig. 8. Variation of Froude Number with Time

tions of measured Froude number for the both opening systems are less than 9% in the range of $0 \leq \Delta \rho_L \leq 0.5 \text{ kg/m}^3$. Therefore, in the present experiment, the Froude number in Table 2 is defined as average of the measured Froude numbers in the range of $0 \leq \Delta \rho_L \leq 0.5 \text{ kg/m}^3$. As was already mentioned, experiments for flow visualization were conducted by Mach-Zehnder interferometer to compare flow patterns. For our understanding of the flow visualization by Mach-Zehnder interferometer, an example of interference fringe pattern of the single opening system is

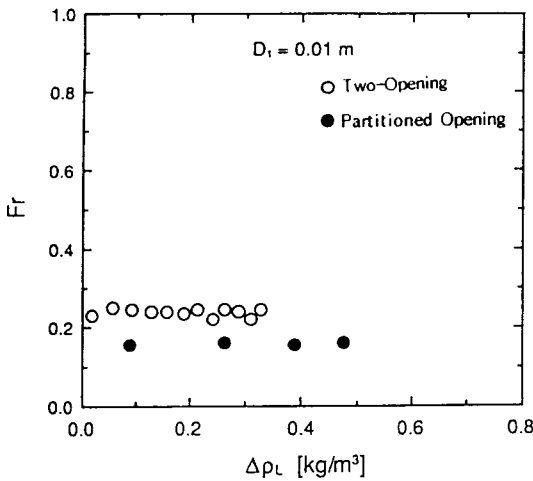

Fig. 9. Variation of Froude Number with Density Increment

introduced in Fig 10. The distorted interference fringes do not appear because there is almost no exchange flow as shown in Fig. 10. Figure 11 shows Mach-Zehnder interferograms of fringes of the air and the gas mixture for the partitioned opening system and the two-opening system at H_1/D_1 of 10. The distorted interference fringes show that the gas mixture flows out of the opening and the straight fringes indicate that the air flows into the opening. According to observations by video camera, the gas mixture flows out of any opening of the two-opening system and the fringes of the gas mixture do not fluctuate laterally as shown in Fig. 11. However, the gas mixture flow of the partitioned opening system swings a little from left to right in lateral direction out of the entrance of the opening, and condition of the exchange flow at the opening entrance is observed to be unstable as shown in Fig. 11. It indicates that the fluids interaction takes place as a flow resistance to the exchange flow. Based on flow visualizations of Fig. 11, it is clearly revealed that amplitude of the gas mixture fringe in the two-opening system is much larger than that of the gas mixture fringe in the partitioned opening system. The exchange flow of the two-opening system due to less flow resistance gives rise to the stable fringe pattern and higher amplitude

Table 2. Comparison of Froude Numbers Between Two Types of Opening System

Opening Type	Froude Number
Two-Opening	0.2381
Partitioned Opening	0.1571

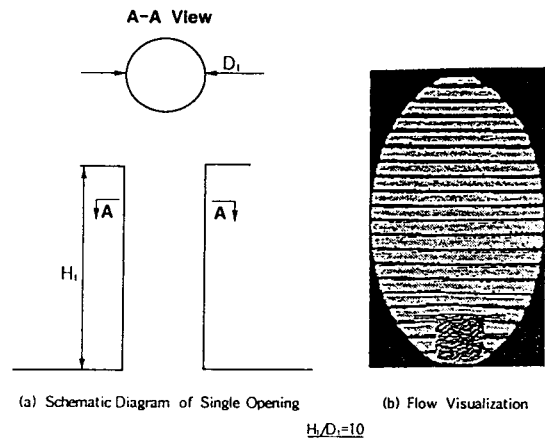

Fig. 10. Example of Flow Visualizations of Single Opening System with Mach-Zehnder Interferometer

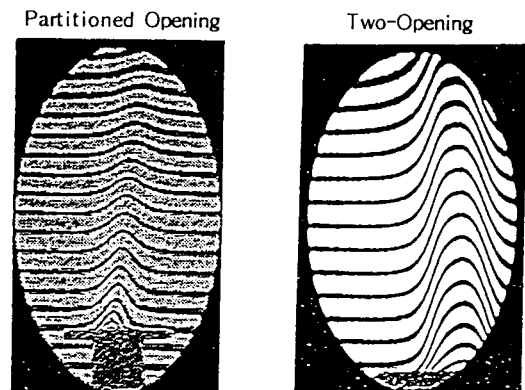

Fig. 11. Comparison of Flow Visualizations with Mach-Zehnder Interferometer

of the gas mixture at the opening entrance. It expedites the exchange flow and the air flows into the test vessel easily. Therefore, absence of the fluids interaction increases the exchange flow rate in two-opening system and Table 2 supports the above discussions.

Table 3. Experimental Condition of Loop Flow Occurrence[2]

Expt. No.	D_{o1} m	D_{o2} m	Reference
1	0.0445	0.0127	
2	0.0445	0.0191	
3	0.0445	0.0294	
4	0.0445	0.0353	
5	0.0445	0.0385	Loop Flow
6	0.0445	0.0445	Loop Flow
7	0.0445	0.0516	Loop Flow
8	0.0445	0.0643	Loop Flow

To explain another reason that the exchange flow rate of the two-opening system is larger than that of the partitioned opening system, an influence of loop flow to give rise to separated flow within the opening is suggested. It is apparent from closely related work reported in the literature that the loop flow expedites the exchange flow [2]. Experiments with brine-water on the loop flow through two openings were reported by Epstein [2]. A total of nine experiments were performed with the two openings, and in this paper, eight cases are introduced for the discussion. In his experiments, height and D_{o1} of opening 1 were fixed and ratio of flow area A_{o1}/A_{o2} was varied by making use of different opening 2 diameters D_{o2} as tabulated in Table 3, where A_{o1} is the flow area of the opening 1 and A_{o2} is the flow area of the opening 2. The openings were separated by a distance approximately 0.15 m in his experiment. These experiments were designed to observe flow patterns in inside of the test vessel as D_{o2} increased. He suggested two different flow configurations by A_{o2}/A_{o1} parameter in the range 0.09 to 25.63. One is unseparated flow which increases the flow resistance and the other is the loop flow observed at $A_{o2}/A_{o1} \geq 0.7485$ in his experiment as shown in Table 3. Therefore, we suggest that the loop flow may occur, because the ratio of flow area A_{o2}/A_{o1} is 1 in the present experiment. A major result of Epstein's investigation was

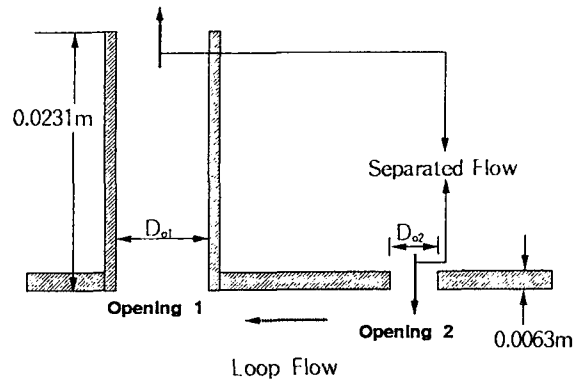

Fig. 12. Schematic Diagram of Loop Flow Observed by Epstein in Two-Opening System[2]

that the strength of the loop flow was sufficient to prevent the downward flow of heavier liquid into opening 1 and the upward flow of lighter liquid into opening 2 in flow configuration shown in Fig. 12. Therefore, the loop flow gives rise to the separated flow which reduces the flow resistance within the opening and it increases the exchange flow rate. We think that the loop flow is another mechanism to expedite the exchange flow. The flow visualization of the loop flow within the test cylinder is not prepared at present stage and it will be necessary to investigate the loop flow for explaining the exchange flow through two-opening completely at next stage.

4. Conclusions

An experimental study of the helium-air exchange flows through the partitioned opening and two-opening has been carried out to understand character of the penetrated air flow at the rupture accident of the stand pipe in the HTTR. In this paper, the effect of fluids interaction on the exchange flow was investigated and discussed experimentally. Conclusions of this paper are summarized in the three groups as follow:

- 1) Based on flow visualization by Mach-Zehnder interferometer, it is observed that the exchange flow of the two-opening system gives rise to the

stable fringe pattern and higher amplitude of the gas mixture.

- 2) The exchange flow rate of the two-opening system is larger than that of the partitioned opening system because of the absence of the fluids interaction.
- 3) The present study is useful in understanding helium-air exchange flow at the rupture accident of the stand pipe in the HTTR.

Nomenclature

A_{o1}	flow area of opening 1 in reference [2] (m^2)
A_{o2}	flow area of opening 2 in reference [2] (m^2)
D_1	inner diameter of opening(m)
D_i	effective diameter of opening(m)
D_{o1}	inner diameter of opening 1 in reference[2] (m)
D_{o2}	inner diameter of opening 2 in reference [2] (m)
Fr	Froude number
g	acceleration due to gravity (m/s^2)
H_1	height of opening (m)
m	mass (kg)
Δm	mass increment (kg)
Q	volume exchange flow rate (m^3/s)
t	elapsed time (s)
V	volume of test vessel (m^3)
δ	partition thickness (m)
ρ	density (kg/m^3)
ρ_m	mean density = $(\rho_H + \rho_L)/2$ (kg/m^3)
$\Delta\rho_L$	density increment (kg/m^3)

Subscripts

H	heavier fluid (air)
He	helium
L	lighter fluid (gas mixture)
t	elapsed time
0	initial condition

Acknowledgments

The author wishes to thank M. Fumizawa of Jap-

an Atomic Energy Research Institute, and H. Madarame and K. Okamoto of the University of Tokyo for a number of useful discussions. The author also wishes to thank N. Kanzaki of the University of Tokyo for her administrative assistances.

References

1. JAERI, "Present Status of HTGR Research and Development," *JAERI Report*, (1992)
2. M. Epstein, "Buoyancy-Driven Exchange Flow Through Small Openings in Horizontal Partitions," *Trans. of ASME*, **110**, 885 (1998)
3. A. Mercer, and H. Thompson, "The Exchange Flow in Inclined Ducts," *J. Br. Nucl. Energy Soc.*, **14**, 327 (1975)
4. A. Mercer, and H. Thompson, "The Purging Flow in Inclined Ducts," *J. Br. Nucl. Energy Soc.*, **14**, 330 (1975)
5. S.J. Leach, and H. Thompson, "An Investigation of Some Aspects of Flow into Gas Cooled Nuclear Reactors Following an Accidental Depressurization," *J. Br. Nucl. Energy Soc.*, **14**, 243 (1975)
6. W.G. Brown, and K.R. Solvason, "Natural Convection Through Rectangular Openings in Partitions-1," *Int. J. Heat Mass Transfer*, **5**, 859 (1962)
7. W.G. Brown, and K.R. Solvason, "Natural Convection Through Rectangular Openings in Partitions-2," *Int. J. Heat Mass Transfer*, **5**, 869 (1962)
8. M. Fumizawa et al., "Experimental Study of Helium-Air Exchange Flow Through a Small Opening," *Kemtechnik*, **57**, 156 (1992)
9. T.I. Kang et al., "Helium-Air Exchange Flow Through a Partitioned Vertical Opening with a Partition," *Proc. 5th Int. Topical Meeting on Nuclear Reactor Thermal Hydraulics*, Salt Lake

- City, Vol. II, 541 (1993)
10. T.I. Kang et al., "Helium-Air Exchange Flow Through Multiple Openings," *Proc. 6th Int. Symposium on Transport Phenomena*, Seoul City, Vol. I, 325 (1993)
 11. W.J. Yang, *Handbook of Flow Visualization*, 2nd ed., p. 205, Hemisphere Publishing Corporation, New York (1989)