

## Application of Smart Transmitter Technology in Nuclear Engineering Measurements

Hyun Gook Kang and Poong Hyun Seong

Korea Advanced Institute of Science and Technology

(Received February 23, 1993)

### 지능형 송출기 기법의 원자력 계측에의 응용

강현국 · 성풍현

한국과학기술원

(1993. 2. 23 접수)

#### Abstract

By making use of the microprocessor technology, instrumentation system becomes intelligent. In this study a programmable smart transmitter is designed and applied to the nuclear engineering measurements. In order to apply the smart transmitter technology to nuclear engineering measurements, the digital time delay compensation function and water level change detection function are developed and applied in this work. The time compensation function compensates effectively the time delay of the measured signal, but it is found that the characteristics of the compensation function should be considered through its application. It is also found that the water level change detection function reduces the detection time to about 7 seconds by the signal processing which has the time constant of over 250 seconds and which has the heavy noise.

#### 요 약

마이크로 프로세서 기술의 도입으로 계측시스템은 점차 지능화 되어가고 있다. 이 연구에서는 원자력 공학에서의 온도 계측에 적용하기 위한 지능형 송출기의 설계가 수행되었다. 지능형 송출기 기법의 원자력에의 응용을 위해 디지털 시간 지연 보상 함수와 수위 측정 알고리즘이 고안, 적용되었다. 시간 보상 함수는 계측된 신호의 시간 지연을 효과적으로 보상하여 주지만, 그 응용에 따라 보상 특성이 고려되어야 한다는 점이 발견되었다. 또한, 수위 계측 함수는 잡음이 많이 섞이고 그 시상수가 250초 이상인 신호를 처리하여 수위 계측 시간을 약 7초로 단축시켜 준다는 사실도 발견하였다.

#### 1. Introduction

By making use of the microprocessor technology, instrument system becomes intelligent. The

smart transmitter is the transmitter which performs some digital processing of the measured signal with the microprocessor embedded in it [1]. Intelligent instrument is one, where after a measure-

ment has been made of a variable, some further processing is carried out to refine the data for presentation to an observer or other computers [2]. The study for using the smart transmitter in the nuclear engineering measurements is now in progress [3].

In this paper, a design of a temperature smart transmitter for the nuclear engineering measurements is performed and the benefits of using the smart transmitter in the nuclear engineering measurements by applying a signal time delay compensation function and a water level change detection function are studied. The smart transmitter is especially designed to put user specified functions in practical use as necessary for the use in nuclear engineering measurements. In order to show the utility of the user function of the programmable smart transmitter, a digital compensation function and a water level change detection algorithm are developed in this work. In measuring the nuclear power plant coolant temperature, the measured temperature parameters should be compensated because of the inherent instrumentation delays of the sensor and the time delays by the piping lags between the reactor core and the loop-temperature-sensors. The effective time compensation and reduction of signal distortion can provide improved reactor operating condition and more accurate calculation of core protection limit. For another example of user programmable function, the temperature signals of the level sensing thermocouples are processed by the smart transmitter. The water level change detection algorithm is studied as an example of the performance of the user programmable function which is based on the signal processing of the programmable smart transmitter. From the viewpoint of safety, the water level sensing is very important to provide an adequate heat sink and to confirm the safety of the system. Liquid level can be sensed by discriminating between the heat transfer of the liquid and that of the vapor phases [4]. The com-

ensation function and the water level change detection algorithm of the programmable smart transmitter can be applied to the level sensing signal processing and it provides more accurate and rapid information on the water levels.

## 2. Programmable Smart Transmitter

### 2.1. General Smart Transmitter Characteristics

The smart transmitter performs not only as the instrumentation system but also as the signal processing system [5,6]. The user can obtain the useful data processed from the measured data in field by using the programmable smart transmitter. Fig. 1 shows the flow chart of the programmable smart transmitter.

Calibration information for RTD and other sensors are stored in the digital memory of the smart

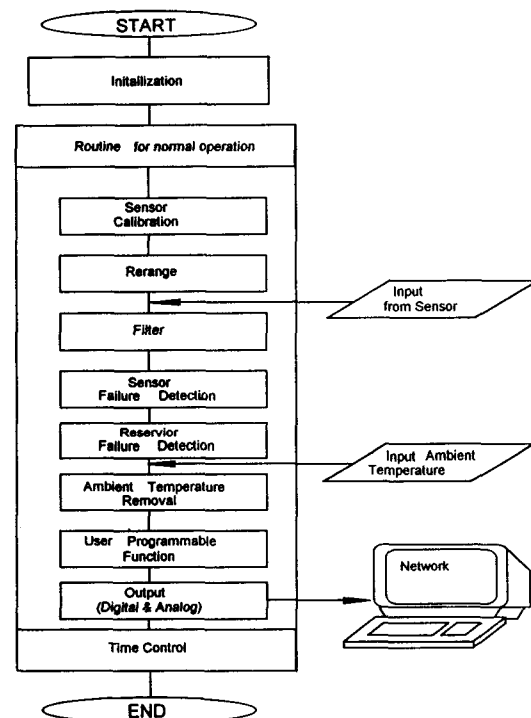

Fig. 1. Functional Flow Chart of The Smart Transmitter

transmitter. This feature allows a unique ability for the user to enter his own calibration curve and thus customize the output of a smart transmitter to conform to almost any input curve. This function of self calibration can reduce the man-power and personal radiation exposure [7,8,9,10]. In the digital filter, we can take the output value of the infinite impulse response(IIR) filter. Not only the noisy signal, but also the overfiltered signal should make unnecessary additional time delay to the instrument system. By the digital data processing and communication, the time constant of the digital filter can be optimized without changing any inner structure of the programmable smart transmitter. The smart transmitter can find the sensor and reservoir failure with embedded failure detection algorithm and can change the operation range by communication between the transmitter and the control room. The smart transmitter can also eliminate the effect due to the ambient temperature by measuring ambient temperature for this function.

**2.2 User Programmable Function and Its Application in Nuclear Engineering Measurements**

The user programmable function of the smart transmitter can be utilized in nuclear engineering measurements. The user function programmability is expected to improve the flexibility of the smart transmitter because it is possible to reduce the complexity of the data computation by user optimized data processing, and the complexity of data communication between the main processor and the field signal.

The utilities of the user programmable function in nuclear engineering measurements are studied in this work and presented in the following section. Firstly the RTD and the thermocouple time delay compensation function is applied and secondly the water level change detection func-

tion for the tank level sensing with the thermocouple is developed and applied.

**3. Applications of User Function**

**3.1 User Function for Compensating Measurement Time Delay**

In order to use the programmable smart transmitter for temperature measurements in the nuclear engineering for time delay compensation, the response time compensation must be done based on the characteristics of the digital transmitter. We can assume the function of real temperature as a straight line in one time step, as  $T_0(t) = at + b$ . Then we can solve the following equation of Newton's cooling law

$$\frac{dT}{dt} = -\tau [T - (at + b)] \tag{1}$$

as

$$T(t) = Ce^{-\frac{t}{\tau}} + at + (b - \frac{a\tau}{\tau}). \tag{2}$$

If we compare the temperature response function  $T(t)$  with original temperature  $T_0(t) = at + b$ , then the compensation part,  $\Delta(t)$ , can be found easily.

$$\Delta(t) = T_0(t) - T(t) = -Ce^{-\frac{t}{\tau}} + \frac{a}{\tau} \tag{3}$$

Now, comparing the derivative of the temperature,  $T'(t)$ , and the compensation part,  $\Delta(t)$ , we can find the correlation as follows :

$$\Delta(t) = \frac{-\tau Ce^{-\frac{t}{\tau}} + a}{-\tau} = \frac{T'(t)}{\tau}. \tag{4}$$

By linear approximation with  $O(h)$ ,  $O(h^2)$  or  $O(h^3)$  the derivative of temperature is obtained respectively as follows [11] :

$$T'(t) \approx \frac{T(t) - T(t-h)}{h} \tag{5}$$

$$T'(t) \approx \frac{3T(t) - 4T(t-h) + T(t-2h)}{2h} \tag{6}$$

$$T'(t) \approx \frac{11T(t) - 18T(t-h) + 9T(t-2h) - 2T(t-3h)}{6h} \quad (7)$$

So the formulation of  $\Delta(t)$  is as follows :

$$\Delta(t) \approx \frac{T(t) - T(t-h)}{h} \quad (8)$$

$$\Delta(t) \approx \frac{3T(t) - 4T(t-h) + T(t-2h)}{2h} \quad (9)$$

$$\Delta(t) \approx \frac{11T(t) - 18T(t-h) + 9T(t-2h) - 2T(t-3h)}{6h} \quad (10)$$

Above equations, Eq. 8, Eq. 9 and Eq. 10 are used to compensate the time delay of measured signal in the digital signal processing. The compensation accuracy depends largely on the measuring time interval,  $h$ . Furthermore, each of the compensation equations has its own typical characteristics, so a proper equation must be selected and must be applied as the user function in calculating the compensated temperature.

### 3.2. User Function for Water Level Change Detection

The water level of the tank and the steam generator can be sensed by discriminating between the heat transfer of the liquid phase and that of the vapor phase. Jun and No of KAIST perform the development of a measurement technique for two-phase mixture level on the basis of the heated thermocouple method [4]. They measure the current of the thermocouple to get the information of the temperature changing when the water surges and outsurges.

In the water tank, the measured temperature change in the case of water insurge is very rapid so the detection of water level is not so hard, however the measured temperature change in the case of water outsurge is not so, as in Fig. 2. The response time of the measuring temperature change is about 700 seconds. The current increasing point in Fig. 2 can be estimated as the time of water level changing. So in the real time system, in order to detect the level change promptly, the

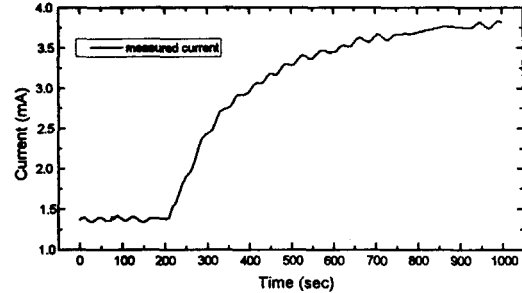

Fig. 2. Measured Signal When Water Outsurge

compensation function of the previous section and the level detection algorithm are applied to the user function simultaneously. Then the operator of the nuclear power plant can sense the water level more rapidly. Furthermore this work can simplify the data communication between the level-sensing thermocouples and the main signal processor because the level signal is determined at field. The water level change detection algorithm is as in Fig. 3 (a). Used parameters are as follows [12] :  $f(t)$  is input signal and the  $X$  is input vector for the level detection algorithm.

$$X = [x1, x2, x3] \quad (11)$$

$$x1 = f(t)$$

$$x2 = f'(t) = \frac{x1 - x01}{\Delta t} \quad (12)$$

$$x3 = f''(t) = \frac{x2 - x02}{\Delta t} \quad (13)$$

The discriminators of  $g1$ ,  $g2$  and  $g3$  are deviation from the setpoint vectors,  $S_1$ ,  $S_2$ , and  $S_3$ , calculation function for  $X$ .

$$S_n = [s1, s2, s3]_n \quad (14)$$

$$s1_n = a1 * \tau * \delta + H \quad (15)$$

$$s2_n = a2 * (\tau - v) \quad (16)$$

$$s3_n = a3 * (\tau - v) \quad (17)$$

$$G1(X) = X - S_1 = [g1, g2, g3]_1 \quad (18)$$

$$G2(X) = X - S_2 = [g1, g2, g3]_2 \quad (19)$$

$$G3(X) = X - S_3 = [g1, g2, g3]_3 \quad (20)$$

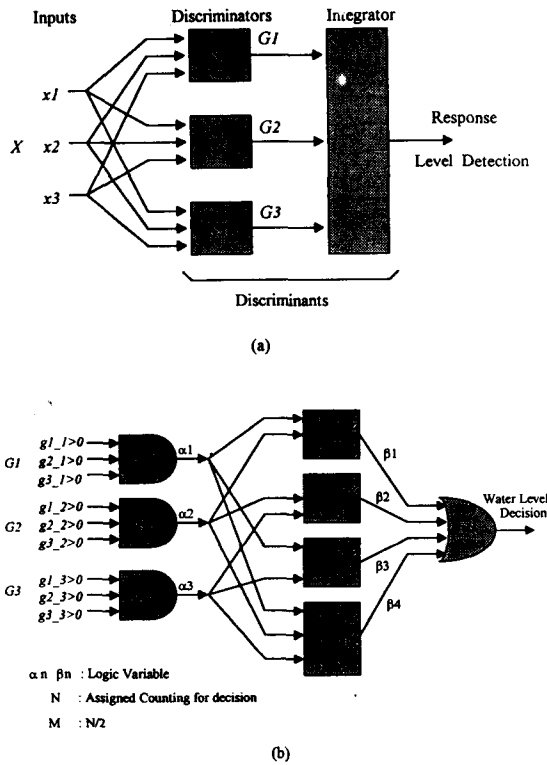

**Fig. 3. (a) Water Level Change Detection Algorithm  
(b) Level Decision Algorithm in The Integrator**

The  $\tau$ ,  $\delta$ ,  $\nu$  and  $H$  are determined by the system. The  $\delta$  is the noise altitude in normal condition, the  $\nu$  is the compensation time and the  $H$  is the nominal current when the thermocouple is in the water. In order to assign adequate values to the vectors of  $G_n[g1, g2, g3]_n$ , the proper  $S_n$  vector must be taken. The integrator performs gathering the information of  $G1$ ,  $G2$  and  $G3$ , counting the detection number and finally making decision of the water level. The integrator has a set of decision criteria to detect the water level and in this paper, the decision criteria are as in Fig. 3 (b) and the setpoint vector  $S_n$  can be found in results of applying above water level change detection algorithm to the input data. Fig. 4 (a), (b) and (c) show the results of water level change detection point for various constant values. The

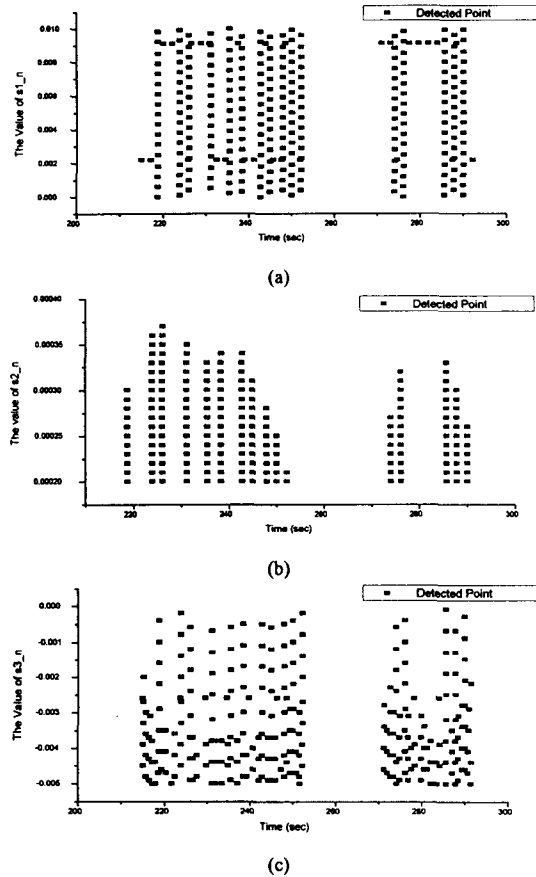

**Fig. 4. (a) (b) (c) The Applied Results of Water level Change Detection To Determine The Setpoint Vectors**

setpoint vector,  $S_n$ , and counting number,  $N$ , of decision criteria can be determined by the user.

### 4. Results

#### 4.1 Digital Processing

The time constant of the compensation function is determined by the sum of the application system delay and the sensor system delay. The total time delay,  $t$  at ramp input signal, can be determined as follows :

$$\tau(t) = \tau_1 + \tau_2(t) + \tau_3 + \tau_4 \quad (21)$$

It is possible to compare the analog data processing system, and the digital data processing system by taking the data paths in Fig. 5 (a). The paths in Fig. 5 (a) are simplified data processing paths for OTΔT setpoint calculation in nuclear power plants [13,14]. If  $\tau_1$  is 2 seconds,  $\tau_2$  is 0.5 second for the digital system,  $\tau_3$  is 4 seconds for the analog system and  $\tau_4$  is 1 second, then  $\tau$  of the digital system is 3.5 seconds and  $\tau$  of the analog system is 7.5 seconds. However, the compensation time constant is taken as 3 seconds, so 0.5 seconds and 4 seconds are unrecoverable time delay for the digital processing and the analog processing respectively. Fig. 5 (b) shows the results of the data processing. It shows that the digital data processing reduces the time delay of the signal and improves the accuracy of measurement, so the core limit margin due to measuring uncertainty can be reduced when the programmable smart transmitter is applied to nuclear engineering measurements.

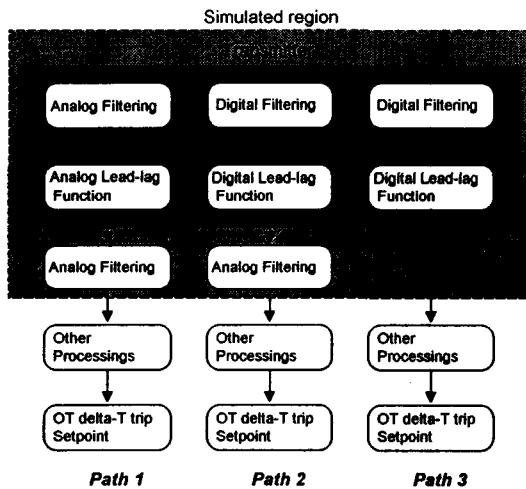

Fig. 5 (a) Various Data Processing Paths for OTΔT Setpoint Calculation

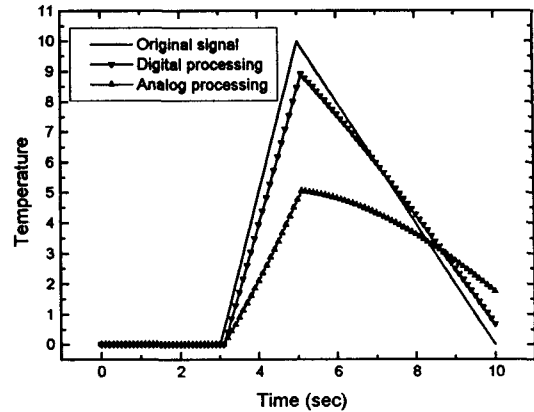

Fig. 5. (b) Results of Digital Data Processing and Analog Data Processing

#### 4.2. Results and Comparison of The Compensation Equations

The digital compensation functions perform the elimination of the time delay of the measured signal, however, the unavoidable error of the digital processing due to the data input time interval,  $h$ . In Fig. 6, the characteristics of the digital compensation function with the  $h$  are shown.

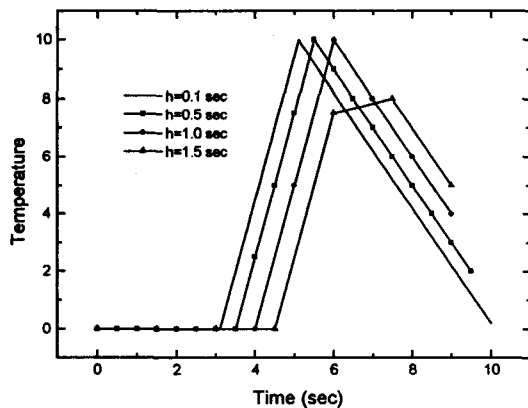
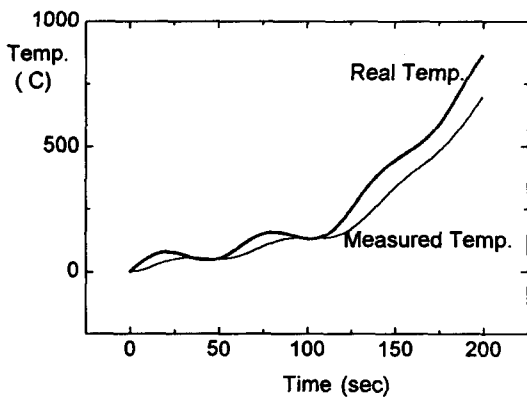
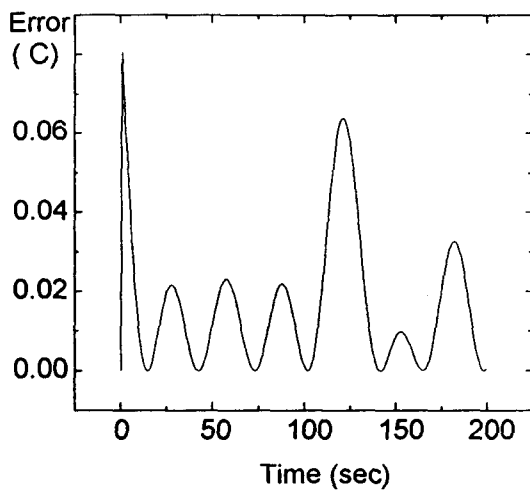

Fig. 6 The Characteristics of Digital Compensation Function with Input Time Interval,  $h$

To apply the compensation function properly, the characteristics of each equation must be analyzed. For the smoothly changing signal, the Eq. 10 shows the most accurate compensation result and the Eq. 8 the worst as shown in Fig. 7. However, for the rapidly changing signal, the Eq. 10 shows the poorest accuracy as in Fig. 8. It is because the Eq. 10 contains the value of three time step before. The Eq. 9 has the characteristics which are the intermediate of Eq. 8 and Eq. 10. So, in the practical system, we must take an appropriate compensation equation in accordance with the



(a)



(b)

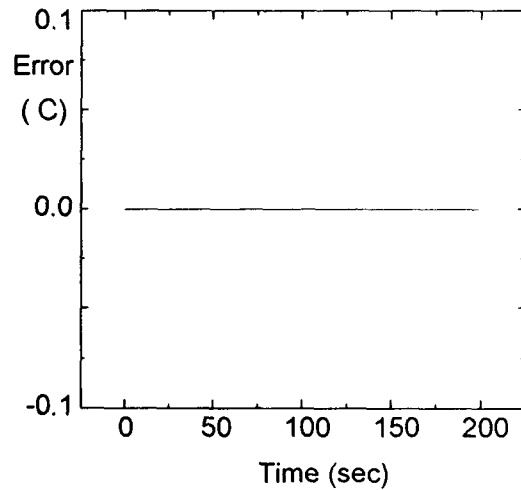

(c)

Fig. 7. (a) Real Temperature and Measured Temperature for Smoothly Changing Case  
(b) The Compensated Error by Eq. 8  
(c) The Compensated Error by Eq. 10

parameter changeability and with the degree of noise.

#### 4.3. Water Level Change Detection

As in the Fig. 2, the signal of measurement has much noise and long system time delay. So, the observer cannot find the water level easily, but the compensated data of the measured signal shows much more clear shape. Fig. 9 shows the compensated data of the measured data and real time level detected point. The current increasing point, around 209-second point, in Fig. 2 can be estimated as the time of the water level changing. The response time to detect the water level is about 700 seconds by the original measured signal, but about 84 seconds by the compensated signal. Furthermore, in the case of applying the compensation function and the level detection algorithm to the programmable smart transmitter,

the water level change detection time is at 217.29-second point, so the response time to detect the water level is reduced to about 8.3 seconds.

Used setpoints,  $S_n$  ( $n=1, 2, 3$ ) are determined by select the  $\tau$ ,  $\delta$ ,  $\nu$  and  $H$  as 145 seconds, 0.05 mA, 240 seconds, and 1.37 mA respectively. The constants of  $a_1$ ,  $a_2$  and  $a_3$  that are used in Eq. 15, Eq. 16, and Eq. 17 respectively, are selected with the Fig. 4 (a), (b), and (c) and the selected values are as followed :

Setpoint \ constant	$a_1$	$a_2$	$a_3$
S1	$2.2 \times 10^{-3}$	$2.0 \times 10^{-4}$	$-5.0 \times 10^{-4}$
S2	$9.1 \times 10^{-3}$	$3.0 \times 10^{-4}$	$-2.6 \times 10^{-3}$
S3	$1.0 \times 10^{-3}$	$2.5 \times 10^{-4}$	$-2.0 \times 10^{-3}$

**5. Conclusion**

It is shown that the accuracy of the instrumentation system is improved by reducing the time delay with the programmable smart transmitter. The programmable smart transmitter which includes the user function as a compensator and water

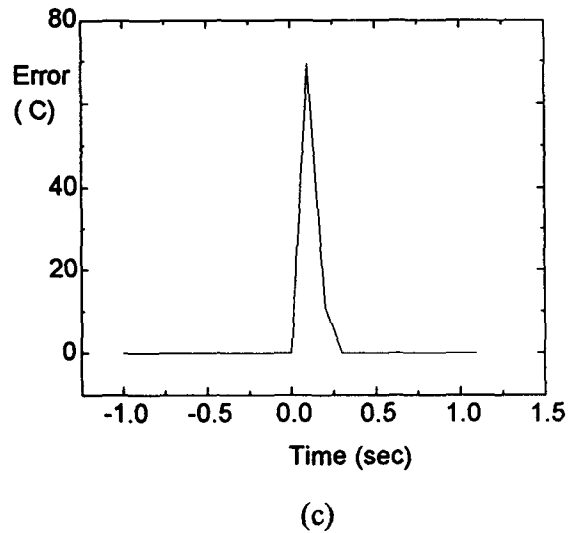
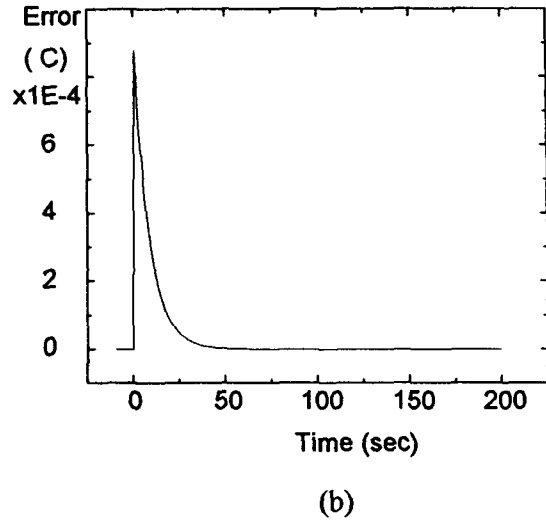
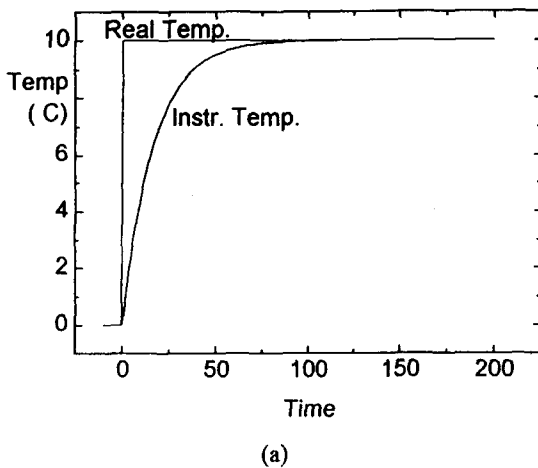

Fig. 8. (a) Real Temperature and Measured Temperature for Step Jump Case  
 (b) The Compensated Error by Eq. 8  
 (c) The Compensated Error by Eq. 10

level detector show good response to the incoming signal by using the information about the optimal operation conditions. Especially it is found to be possible to detect the water level rapidly in heavy noisy and bad responding system.



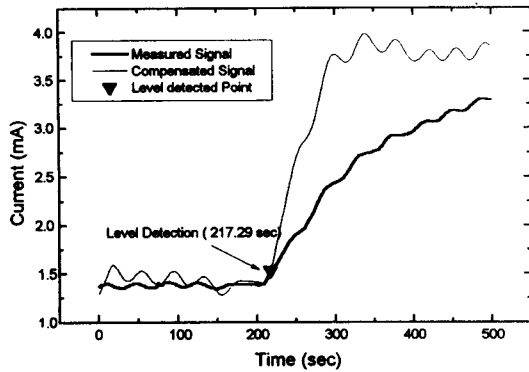

Fig. 9. Measured Signal, Compensated Signal and Level Detected Points

**Nomenclature**

- X : input vector for the level detection algorithm,  $[x1,x2,x3]$
- x1 : input 1 for the level detection algorithm (measured signal by the sensor)
- x2 : input 2 for the level detection algorithm (first order derivative of the measured signal)
- x3 : input 3 for the level detection algorithm (first order derivative of the measured signal)
- $S_n$  : setpoint vector for the level detection algorithm,  $[s1,s2,s3]_n$
- $s_n$  : setpoint for  $x_n$
- $G_n$  : deviation from the setpoint vector,  $S_n$  to the input value, X
- $g_n$  : deviation from the setpoint and input value
- T(t) : measured temperature at t
- $\tau(t)$  : time delay of the measured signal
- $\tau_1$  : time delay by the application system
- $\tau_2(t)$  : time delay by the digital filter (function of time)
- $\tau_3$  : sum of the time delays by the analog filters
- $\tau_4$  : time delay by the sensor system
- $\nu$  : compensation time
- $\delta$  : the noise altitude in the normal condition

- H : nominal current that the thermocouple is in the water
- t : time
- $\Delta t$  : time step
- h : time interval (unit time step of the digital processing)
- a,a1,a2,a3,b : constants

**References**

1. Clifford W. Lewis, "The Smart Future of Two-wire Temperature Transmitters", InTech. (February 1990).
2. George C. Barney, *Intelligent Instrumentation : Microprocessor Applications in Measurement and Control*, Prentice Hall, 231-329. (1985)
3. D. Wilkinson et al. ed., *Integrated Instrumentation and Control Upgrade Plan*, EPRI NP-7343 Project 3114-59. (February 1992).
4. Byung Soon Jun, "Experimental Investigation of Two-Phase Mixture Water Level Tracking in Nuclear Steam Generators", Mater thesis, KAIST (January 1993).
5. Rosemount, *Smart Family*, Product Data Sheet 2659.
6. Kent M. Petersen, "Evaluation of Smart Sensor Technologies for Instrument Calibration Reduction in Nuclear Power Plants", 20th Water Reactor Safety Information Meeting. (October 1992).
7. T. W. Kerlin and R. L. Shepard, *Industrial Temperature Measurement*.
8. Mike Westbrook, "Automotive Sensors", InTech. (October 1989).
9. E. Lee Garelick, "Why Calibrate SMART Instruments", InTech. (February 1990).
10. Peter E. Langan and Donald S. Ironside, "Calibration Ensures Accurate Temperature Measurement/Control", InTech. (October 1989).
11. Melvin J. Maron, *Numerical Analysis : A Prac-*

- tical Approach, Macmillan Publishing Co. Inc. (1982).
12. Nello Zuech ed., *Handbook of Intelligent Sensor for Industrial Automation*, Addison-Wesley Publishing Company, Inc. (October 1991).
  13. Westinghouse Electric Corp., *Design Bases for The Thermal Overpower DT and Thermal Overtemperature  $\Delta T$  Trip Functions*. (March 1977).
  14. Jin-Ho Park, Han-Young Yoon, Hee Cheol Kim, and Chong-Chul Lee, "Optimization of Dynamic Terms in Core Overtemperature Delta-T Trip Function", KNS Vol. 24 No. 3. (September 1992).