

## Generation and Benchmarking of a 69-group Cross Section Library for Thermal Reactor Applications

Jung-Do Kim, Jong Tai Lee, Choong-Sup Gil and Hark Rho Kim

Korea Advanced Energy Research Institute  
(Received May 30, 1989)

### 열중성자로 핵계산을 위한 69군 단면적 라이브러리 생산 및 검증

김정도 · 이종태 · 길충섭 · 김학노  
한국에너지연구소  
(1989. 5. 30 접수)

#### Abstract

A 69-group cross section library consisting of more than 130 materials was generated for thermal reactor applications using the NJOY nuclear data processing system and the recent version of evaluated nuclear data files available from IAEA Nuclear Data Section. The multigroup library was validated through the analysis of various criticality experiments and depletion results of PWR. When used with the WIMS-KAERI code, the average  $K_{eff}$  obtained for 47 uranium-oxide and 41 uranium metal fueled critical configurations is 0.9997 with a standard deviation of 0.69 percent. The calculated burnup dependent isotopic inventories of uranium and plutonium generally show good agreement with measured values obtained from depleted PWR pins.

#### 요 약

열중성자로의 핵계산을 위한 69군 단면적 라이브러리를 생산하였다. 기본 평가핵자료로는 IAEA Nuclear Data Section에서 수집된 자료가, 그리고 이를 처리하여 균정수화 하는데는 NJOY 코드가 이용되었다. 새로이 마련된 라이브러리의 유용성을 검증하기 위해 각기 산화우라늄과 금속 우라늄 연료로 구성된 임계실험체를 WIMS-KAERI 코드로 계산된 결과와 비교, 검토하였다. 총 88임계결과에 대해 평균  $K_{eff}$  값 0.9997, 그리고 표준 편차 0.69%를 보였다. PWR 연료의 연소결과로 얻어진 우라늄과 플루토늄 생성량에 대한 평가에서도 전반적으로 좋은 결과를 얻었다.

#### I. Introduction

In nuclear design analysis for reactors or radiation facilities, nuclear data are of primary impor-

tance. Since reactor analysis methods cannot treat the full space-energy detail of the core, the first step in the analysis is to prepare few-group cell-averaged cross sections using a computer

code like the LEOPARD<sup>1)</sup>, LASER<sup>2)</sup>, WIMS<sup>3)</sup> etc. The conditions in the reactor cell change with time due to the buildup and depletion of fission products and actinides. Therefore, the cell code must be able to compute the detailed flux at a number of time steps through the life of the core, calculate the average cross sections, and predict the changes in nuclide concentrations. For best results, these calculations require libraries of accurate cross sections based on standard, publicly available evaluated nuclear data produced using well described methods.

In order to provide an up-to-date multigroup data for thermal reactor calculations, a new 69-group cross section library was generated with the recent version of evaluated nuclear data files<sup>4)</sup> available from the Nuclear Data Section (NDS) of IAEA using the nuclear data processing system NJOY<sup>5)</sup>, which has the capability of producing most of multigroup data required for thermal reactor analysis as well as fast reactors.

The quality of a multigroup cross section data cannot be judged independently without the particular combination of data and methods in the complex environment of reactor analysis. In order to validate the adequacy of the newly generated multigroup data library for use in nuclear design analysis, benchmarkings were performed using the WIMS-KAERI code<sup>6)</sup> by the experimentally determined criticalities and isotopic inventories in depleted PWR fuels.

## 2. 69-group Data Library

The energy group structure selected is 69 groups with energy boundaries corresponding to those of the original WIMS library. The first 14 'fast' energy groups have equal half lethargy intervals in the range 10 MeV to 9.118 keV. Below 9.118 keV there are 13 'resonance' energy groups down to 4 eV, and below 4 eV in the 'thermal' region there are 42 groups.

## 2.1 Sources of Basic Nuclear Data

Most of the evaluated nuclear data were taken from the ENDF/B-V<sup>7)</sup> or IV<sup>8)</sup>, but some data, not available from the released ENDF/B files, were taken from the JENDL-2 (Rev.1)<sup>9)</sup> and ENDF-84<sup>10)</sup>. Used data files are the following:

- ENDF/B-V            Standard File
- ENDF/B-V            Actinide File
- ENDF/B-V            Fission Product File
- ENDF/B-V            Fission Product Yield File
- ENDF/B-V            Dosimetry File
- ENDF/B-IV          General Purpose File
- ENDF/B-III          Scattering Law File
- JENDL-2 (Rev.1)    General Purpose File
- ENDF-84             General Purpose File.

## 2.2 Data Processing Routines

The data processing to convert ENDF/B-formatted source data to multigroup data requires a number of routines such as pointwise, Doppler-broadening, thermal scattering kernel, self-shielding, group weighting etc. The NJOY is composed of a modular system for a variety of nuclear data processing of ENDF/B-formatted files. In the source data processing, the NJOY and an auxiliary routine were used. Detailed descriptions on the routines are described in References 5 and 12.

## 2.3 Contents of the Library

The 69-group data library contains fission, absorption and transport cross sections,  $P_0$  scattering matrices, and fission neutron yield. Some additional parameters are included in this library for use in the resonance calculations: slowing down parameters, Goldstein-Cohen parameters, potential scatterings, and resonance integrals for self-shielding effects and  $P_1$  matrices for some

moderator materials to be used in B-1 approximation are included. Fission product and actinide depletion chains as well as fission yield data and  $\beta$  decay constants are also included in the library.

## 2.4 Generation of the Library

In the group averaging, a combined Maxwellian +  $1/E$  + fission spectrum was used for weighting. The thermal portion is Maxwellian with a temperature of 0.0253 eV which joins  $1/E$  at 0.1 eV. The fission spectrum joins  $1/E$  at 674.0 keV and has a characteristic temperature of 1.27 MeV. In the NJOY system, a weighting flux of the actinide nuclides can be produced by a point-wise solution of the slowing down equations for the heavy absorber mixed with a light moderator in order to take accurately account of broad and intermediate resonance effects in the epithermal region. The fine-group weighting fluxes calculated with the above method were used for main actinide weighting.

The thermal scattering kernels for most nuclides were computed with the free gas model, and with some exceptions. The special thermal scattering kernels for hydrogen bound in  $H_2O$  and ZrH, deuterium bound in  $D_2O$ , and graphite were computed using the scattering law data from ENDF/B library. The transport cross sections for all nuclides, except hydrogen and deuterium, were computed using the row sum correction from  $P_1$  scattering matrix data. For the above two, a weighted column sum correction was applied to groups above 4 eV. For most nuclides the  $P_1$  data were only stored implicitly in the library in the form of transport corrections. But for the principal moderators, explicit  $P_1$  matrix data were attached to the end of the library. Only four  $P_1$  matrices are processed. These are one each for hydrogen, deuterium, oxygen and carbon, and are a single temperature, 300°K, only. The Goldstein-Cohen parameters were taken from the

reported data<sup>11)</sup>, which vary smoothly with atomic weight and are assumed to have energy independent values, without critical evaluation. The potential scattering cross sections were processed from the source data files. The (n, 2n) cross sections were subtracted from absorption cross sections to conserve total cross sections.

Fission spectra of U-235 were generated from Watt spectrum data of ENDF/B-V. Most actinides have the self-shielded resonance integral data according to some temperatures and background cross sections. The capture and fission cross sections of U-238 and Th-232 were processed from ENDF/B-V data.

In order to improve the effect of actinide in high burnup characteristics, the actinide burnup chain model was improved by adding most actinides such as neptunium, americium and curium. However, because of the limitations of a single capture and decay product in burnup chain, it was assumed in the library that a capture in Am-241 produces 0.14 atoms of Am-242m, and that Am-242g branch of the chain can be neglected. The (n, 2n) production from U-238 was modeled in the burnup chain as shown in Fig. 1.

The energy released in a reactor per fission of a fissionable nuclide is composed of the energy which results directly from fission and the energy of the gamma quanta released from capture of fission neutrons. The former was processed from each source files and the latter was evaluated with 5.65 MeV per neutron.<sup>26)</sup> The fission product yields were taken into account for all fissionable nuclides, and the yield values were produced from ENDF/B-V Fission Product Yield File.

In the model of fission product chain, 35 fission products are represented explicitly whilst the remainder is combined in a single pseudo-fission product. The lumped fission product is to include the absorption from all isotopes not treated explicitly in the fission product representation. All

cross sections for the explicitly treated fission product nuclides were processed from ENDF/B-V data. The pseudo-fission product data used in this library are taken from the old WIMS library

without adjustment. The fission product and actinide burnup chain models used in the library are shown in Figures 1 and 2, respectively.

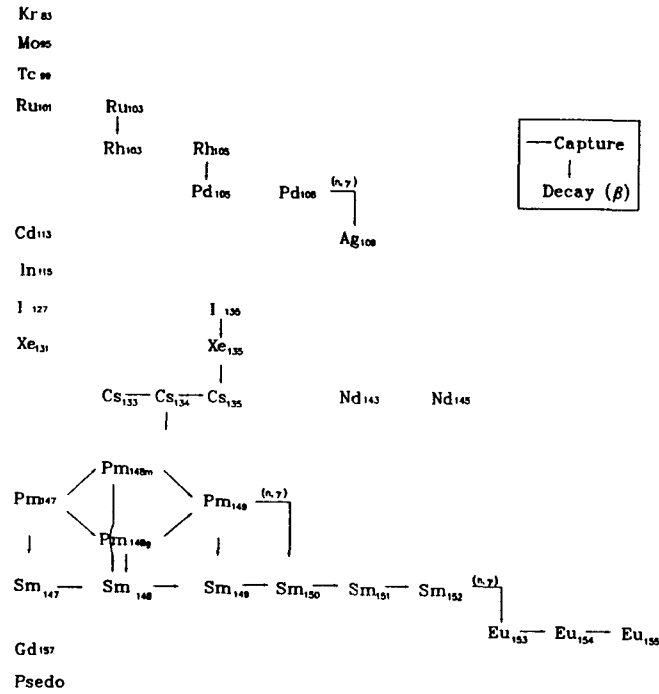

Fig. 1. Fission Product Chain used in the 'WIMKAL-88' Library

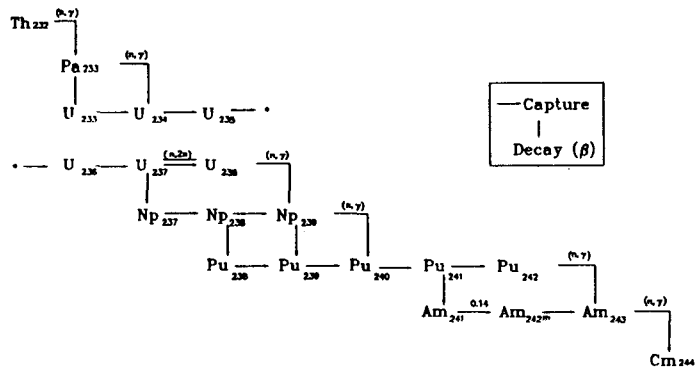

Fig. 2. Actinide Burnup Chain used in the 'WIMKAL-88' Library

The newly generated 69-group cross section library, designated WIMKAL-88 (WIMS-KAERI Library 1988 Version), contains data for more than 130 nuclides including reactor fuel, moderator, structure materials, fission products and actinide nuclides as well as miscellaneous radioisotopes to be produced in the research and/or power reactors. More detailed contents for the WIMKAL-88 are described in Ref. 12.

The advantages of the WIMKAL-88 can be summarized as the following.

- All data were derived from the latest version of the evaluated nuclear data files available from the NDS of IAEA.
- Transport cross sections were computed using  $P_1$  scattering matrix data.
- Within-group weighting fluxes for actinides were computed on an ultra-fine group basis for accurate intermediate resonance self-shielding.
- Fission spectra of U-235 were produced from Watt spectrum data in ENDF/B-V.
- More explicit representation was adopted for fission-product chain.
- More extensive representation of actinide burnup chain including thorium cycle was selected.

### 3. Benchmarkings

An extensive benchmarking of the WIMKAL-88 by means of the WIMS-KAERI code, which is a revised KAERI version of WIMS/D4, was carried out by comparing results of pin-cell calculations with those of experimentally determined criticalities and depletions.

### 3.1 Analysis of Critical Experiments

A variety of critical experiments were analyzed using measured bucklings as input to fundamental mode calculation. These calculations give only approximate eigenvalues due to the uncertainties in the experimental bucklings, but still serve as an indicator of the reliability of multigroup cross section library.

Experimental data for a large number of critical and/or exponential lattices of uranium-oxide and uranium metal fuel have been collected from the literatures<sup>12-23</sup>). The main part is from Strawbridge and Barry's collection<sup>16</sup>). The cases were limited, with a few exceptions, to lattices for which experimental bucklings have been reported. The lattices selected have a variety of fuel enrichment, pin size, pitches, and leakage fractions. And some criticals have D<sub>2</sub>O as moderator, and contain boron in moderator. Detail specifications of the selected experiments are listed in Table 1. And Table 2 gives computed eigenvalues for the UO<sub>2</sub> and metal fueled criticals.

**Table 1. Specifications for Critical Benchmarkings**(a) Data for UO<sub>2</sub> Criticals

Case No.	Enrichment (at. %)	Fuel Density (g/cm <sup>3</sup> )	Pellet Dia. (cm)	Clad Material	Clad OD (cm)	Clad Thick. (cm)	Lattice Pitch (cm)	D <sub>2</sub> O Mole Fraction	Boron Conc. (ppm)	Critical Buckling (m <sup>-2</sup> )	Ref.
1x	2.734	10.18	.7620	SS304	.8594	.04085	1.0287		0	40.75	12
2x	2.734	10.18	.7620	SS304	.8594	.04085	1.1049		0	53.23	12
3x	2.734	10.18	.7620	SS304	.8594	.04085	1.1938		0	63.26	12
4x	2.734	10.18	.7620	SS304	.8594	.04085	1.4554		0	65.64	13
5x	2.734	10.18	.7620	SS304	.8594	.04085	1.5621		0	60.07	13
6x	2.734	10.18	.7620	SS304	.8594	.04085	1.6891		0	52.92	13
7x	2.734	10.18	.7620	SS304	.8594	.04085	1.0617		0	47.50	14
8x	2.734	10.18	.7620	SS304	.8594	.04085	1.2522		0	68.80	14
9x	3.745	10.37	.7544	SS304	.8600	.04060	1.0617		0	68.30	14
10x	3.745	10.37	.7544	SS304	.8600	.04060	1.2522		0	95.10	14
11x	3.745	10.37	.7544	SS304	.8600	.04060	1.2522		0	95.68+	15
12x	3.745	10.37	.7544	SS304	.8600	.04060	1.2522		456	74.64+	15
13x	3.745	10.37	.7544	SS304	.8600	.04060	1.2522		709	63.64+	15
14x	3.745	10.37	.7544	SS304	.8600	.04060	1.2522		1260	49.99+	15
15x	3.745	10.37	.7544	SS304	.8600	.04060	1.2522		1334	38.39+	15
16x	3.745	10.37	.7544	SS304	.8600	.04060	1.2522		1477	38.38+	15
17x	5.809	10.19	.9068	SS304	.9931	.03810	1.3208		0	117.60	16
18x	4.069	9.46	1.1278	SS304	1.2090	.04060	1.5113		0	88.00	17
19x	4.069	9.46	1.1278	SS304	1.2090	.04060	1.5113		3392	17.20	17
20x	4.069	9.46	1.1278	SS304	1.2090	.04060	1.5113	.7650	0	10.77	17
21x	4.069	9.46	1.1278	SS304	1.2090	.04060	1.5113	.7377	0	14.33	17
22x	4.069	9.46	1.1278	SS304	1.2090	.04060	1.5113	.7377	0	14.09	17
23x	4.069	9.46	1.1278	SS304	1.2090	.04060	1.5113	.6970	0	18.60	17
24x	4.069	9.46	1.1278	SS304	1.2090	.04060	1.5113	.4966	0	44.00	17
25x	4.069	9.46	1.1278	SS304	1.2090	.04060	1.5113		0	79.00	17
26x	4.069	9.46	1.1278	SS304	1.2090	.04060	1.5113	.7007	0	12.40	17
27x	4.069	9.46	1.1278	SS304	1.2090	.04060	1.5113	.4968	0	34.60	17
28x	3.037	9.28	1.1268	SS304	1.2701	.07163	1.5550		0	50.75	18
29x	3.037	9.28	1.1268	SS304	1.2701	.07163	2.1980		0	68.81	18
30x	4.069	9.45	1.1268	SS304	1.2701	.07163	1.5550		0	69.25	18
31x	4.069	9.45	1.1268	SS304	1.2701	.07163	1.6840		0	85.52	18
32x	4.069	9.45	1.1268	SS304	1.2701	.07163	2.1980		0	92.84	18
33x	4.069	9.45	1.1268	SS304	1.2701	.07163	2.3810		0	91.79	18
34x	1.328	7.53	1.5265	Al	1.6916	.07110	2.2050*		0	28.37	19
35x	1.328	7.53	1.5265	Al	1.6916	.07110	2.3590*		0	30.17	19

Case No.	Enrichment (at. %)	Fuel Density (g/cm <sup>3</sup> )	Pellet Dia. (cm)	Clad Material	Clad OD (cm)	Clad Thick. (cm)	Lattice Pitch (cm)	D <sub>2</sub> O Mole Fraction	Boron Conc. (ppm)	Critical Buckling (m <sup>-2</sup> )	Ref.
36x	1.328	7.53	1.5265	Al	1.6916	.07110	2.5120*		0	29.06	19
37x	1.328	7.52	.9855	Al	1.1506	.07110	1.5580*		0	25.28	19
38x	1.328	7.52	.9855	Al	1.1506	.07110	1.6520*		0	25.21	19
39x	1.328	10.53	.9728	Al	1.1506	.07110	1.5580*		0	32.59	19
40x	1.328	10.53	.9728	Al	1.1506	.07110	1.6520*		0	35.47	19
41x	1.328	10.53	.9728	Al	1.1506	.07110	1.8060*		0	34.22	19
42x	2.490	10.24	1.0297	Al	1.2060	.08130	1.5113		1675	20.20	17
43x	2.490	10.24	1.0297	Al	1.2060	.08130	1.5113	.7200	0	14.75	17
44x	2.490	10.24	1.0297	Al	1.2060	.08130	1.5113	.7009	0	17.47	17
45x	2.490	10.24	1.0297	Al	1.2060	.08130	1.5113	.4976	0	39.36	17
46x	2.490	10.24	1.0297	Al	1.2060	.08130	1.7020	.8550	0	12.79	17
47x	2.490	10.24	1.0297	Al	1.2060	.08130	1.7020	.7000	0	33.70	17

\* Hexagonal Lattice; All others are square.

+ These bucklings were not measured directly but were inferred from critical loadings.

**Table 1. (Continued)**

(b) Data for U-Metal Criticals

Case No.	Enrichment (at. %)	Fuel Density (g/cm <sup>3</sup> )	Pellet Dia. (cm)	Clad Material	Clad OD (cm)	Clad Thick. (cm)	Lattice Pitch* (cm)	Critical Buckling (m <sup>-2</sup> )	Ref.
1m	1.307	18.9	1.5240	Al	1.6916	.07112	2.1742	32.11	20
2m	1.307	18.9	1.5240	Al	1.6916	.07112	2.4054	51.87	20
3m	1.307	18.9	1.5240	Al	1.6916	.07112	2.6162	61.08	20
4m	1.307	18.9	1.5240	Al	1.6916	.07112	2.9896	60.99	20
5m	1.307	18.9	1.5240	Al	1.6916	.07112	3.3249	50.28	20
6m	1.160	18.9	1.5240	Al	1.6916	.07112	2.1742	21.19	20
7m	1.160	18.9	1.5240	Al	1.6916	.07112	2.4054	40.23	20
8m	1.160	18.9	1.5240	Al	1.6916	.07112	2.6162	48.22	20
9m	1.160	18.9	1.5240	Al	1.6916	.07112	2.9896	47.12	20
10m	1.160	18.9	1.5240	Al	1.6916	.07112	3.3249	36.03	20
11m	1.040	18.9	1.5240	Al	1.6916	.07112	2.1742	9.66	21
12m	1.040	18.9	1.5240	Al	1.6916	.07112	2.4054	29.60	21
13m	1.040	18.9	1.5240	Al	1.6916	.07112	2.6162	35.83	21
14m	1.040	18.9	1.5240	Al	1.6916	.07112	2.9896	32.93	21
15m	1.040	18.9	1.5240	Al	1.6916	.07112	3.3249	21.01	21
16m	1.307	18.9	0.9830	Al	1.1252	.07112	1.4412	20.90	22

Case No.	Enrichment (at. %)	Fuel Density (g/cm <sup>3</sup> )	Pellet Dia. (cm)	Clad Material	Clad OD (cm)	Clad Thick. (cm)	Lattice Pitch* (cm)	Critical Buckling (m <sup>-2</sup> )	Ref.
17m	1.307	18.9	0.9830	Al	1.1252	.07112	1.5926	40.51	22
18m	1.307	18.9	0.9830	Al	1.1252	.07112	1.7247	52.19	22
19m	1.307	18.9	0.9830	Al	1.1252	.07112	1.9609	59.25	22
20m	1.307	18.9	0.9830	Al	1.1252	.07112	2.1742	54.69	22
21m	1.160	18.9	0.9830	Al	1.1252	.07112	1.5926	31.21	22
22m	1.160	18.9	0.9830	Al	1.1252	.07112	1.7247	42.17	22
23m	1.160	18.9	0.9830	Al	1.1252	.07112	1.9609	46.18	22
24m	1.160	18.9	0.9830	Al	1.1252	.07112	2.1742	40.14	22
25m	1.040	18.9	0.9830	Al	1.1252	.07112	1.4412	3.23	22
26m	1.040	18.9	0.9830	Al	1.1252	.07112	1.5926	19.70	22
27m	1.040	18.9	0.9830	Al	1.1252	.07112	1.7247	29.02	22
28m	1.040	18.9	0.9830	Al	1.1252	.07112	1.9609	31.39	22
29m	1.040	18.9	0.9830	Al	1.1252	.07112	2.1742	25.68	22
30m	1.040	18.9	1.905	Al	2.0574	.07620	2.8687	28.90	20
31m	1.040	18.9	1.905	Al	2.0574	.07620	3.0086	34.70	20
32m	1.040	18.9	1.905	Al	2.0574	.07620	3.1425	37.50	20
33m	1.040	18.9	1.905	Al	2.0754	.07620	3.3942	36.70	20
34m	1.040	18.9	1.905	Al	2.0754	.07620	3.6284	32.90	20
35m	1.040	18.9	1.905	Al	2.0574	.07620	4.0566	18.60	20
36m+	1.310	18.88	1.5240	Al	1.6916	.07112	2.616	61.12	19
37m+	1.310	18.88	1.5240	Al	1.6916	.07112	2.990	61.09	19
38m+	1.159	18.88	1.5240	Al	1.6916	.07112	2.616	48.31	19
39m+	1.159	18.88	1.5240	Al	1.6916	.07112	2.990	47.26	19
40m+	1.312	18.88	0.9830	Al	1.1506	.07112	1.725	53.55	19
41m+	1.312	18.88	0.9830	Al	1.1506	.07112	1.961	58.20	19

\* Hexagonal Lattice.

+ These cases are critical experiments; All others are exponential experiments.



**Table 2. Calculated  $K_{eff}$  Values**

(a)  $UO_2$  Criticals

Case No.	$K_{eff}$	Case No.	$K_{eff}$
1x	1.01228	26x	0.99761
2x	1.01154	27x	0.99932
3x	1.00767	28x	0.99783
4x	1.00928	29x	0.97910
5x	1.01046	30x	1.00606
6x	1.00547	31x	0.99974
7x	1.00956	32x	1.00319
8x	1.00099	33x	0.98621
9x	1.01237	34x	1.00289
10x	1.00685	35x	1.00412
11x	1.00528	36x	1.00164
12x	0.99977	37x	1.00327
13x	0.99752	38x	1.00145
14x	0.99528	39x	1.00771
15x	0.99429	40x	1.00634
16x	0.99269	41x	1.00357
17x	1.00988	42x	1.00686
18x	1.00097	43x	1.00946
19x	0.99765	44x	1.00606
20x	1.00245	45x	1.00158
21x	1.00281	46x	1.01057
22x	1.00417	47x	1.01002
23x	1.00800		
24x	0.99789	Average	1.00289
25x	0.99623	Standard Deviation	0.00661

**Table 2. (Continued)**

(b) U-Metal Criticals

Case No.	$K_{eff}$	Case No.	$K_{eff}$
1m	0.98422	23m	0.99726
2m	0.99391	24m	0.99479
3m	0.99462	25m	0.99874
4m	0.99433	26m	1.00783
5m	1.01046	27m	1.00395
6m	0.99263	28m	1.00077
7m	0.98799	29m	0.99469
8m	0.99518	30m	0.99266
9m	0.99341	31m	0.99286
10m	0.99052	32m	0.99317
11m	0.99520	33m	0.99526
12m	0.99392	34m	0.99279
13m	0.99608	35m	0.98790
14m	0.99527	36m	0.99498
15m	0.99271	37m	0.99453
16m	0.99269	38m	0.99460
17m	1.01017	39m	0.99264
18m	1.00684	40m	0.99687
19m	1.00030	41m	1.00038
20m	0.99691		
21m	1.00510	Average	0.99613
22m	1.00031	Standard Deviation	0.00522

In these calculations using the WIMS-KAERI code, the discrete ordinates method was used with  $P_1$  scattering and 8 discrete angular directions. It is apparent that for the primary set of 47  $UO_2$  fueled lattices, the WIMKAL-88 library gives only 0.29% higher than unity on the average value of  $K_{eff}$ , but for 41 metal fueled lattices, it gives 0.39% lower than unity. Nevertheless, the fact that the WIMKAL-88 library using the WIMS-KAERI code can obtain an average

$K_{eff}$  of 0.99974 with 0.689% standard deviation for such a wide range of lattices is indicative of the validity of the library.

In order to investigate systematic errors in the proposed calculations, the calculated  $K_{eff}$  values have been plotted against some parameters. Figures 3 and 4 show all points plotted versus the moderator-to-fuel volume ratios and the reported bucklings, respectively. No dependencies on these parameters are observed.

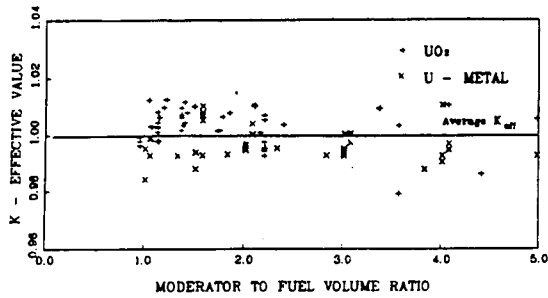

Fig. 3. Calculated  $K_{eff}$  Values versus Moderator-to-Fuel volume Ratios

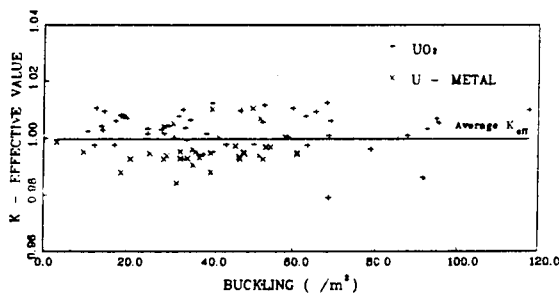

Fig. 4. Calculated  $K_{eff}$  Values versus Experimental Bucklings

### 3.2 Analysis of Depletion Experiments

Depletion benchmarking was performed by comparing the buildup and depletion data of uranium and plutonium isotopes determined experimentally by destructive analysis of fuel pellets removed from Yankee power reactor. The Yankee is a pressurized water reactor. A detailed description of the reactor characteristics and measured data can be found in References 24 and 25.

The Yankee has a uniform lattice pitch except in the neighborhood of water slots where the effective pitch is somewhat larger. The calculation was performed with the normal pitch, and comparisons with experiments were made with isotopic inventories obtained from fuel rods

Table 3. Specifications of Yankee Lattice used in the Present Calculation

(a) Characteristics

Cold Pitch (cm)	: 1.072
Hot Pitch (cm)	: 1.077
Fuel Temperature ( $^{\circ}$ C)	: 593.333
Moderator Temperature ( $^{\circ}$ C)	: 267.778
Fuel ( $UO_2$ ) Density ( $g/cm^3$ )	: 10.18
Clad (SS347) Density ( $g/cm^3$ ):	7.3872

(b) Cell Geometry

Region Number	Type	Region Thickness (cm)
1	Fuel ( $UO_2$ )	0.3734
2*	Clad (SS347)	0.0604
3	Moderator ( $H_2O$ )	0.1735

\* The pellet-to-clad gap has been homogenized with the SS347.

(c) Atom Number Densities ( $\times 10^{24}$  atom/ $cm^3$ )

Region	Nuclide	Number Density
Fuel ( $UO_2$ )	U-234	0.00000454
	U-235	0.00078125
	U-236	0.00000454
	U-238	0.02192039
Clad (SS347)	Fe	0.0545015
	Cr	0.0154002
	Ni	0.0079591
	Mn-55	0.0016195
	Si	0.0015840
Moderator ( $H_2O$ )	C	0.0000401
	H	0.052386
	O	0.026193

located in the center of the fuel assemblies away from water slots and control rods, where the effects of non-uniformities in the lattice are negligible. The fuel pin-cell was modeled in the

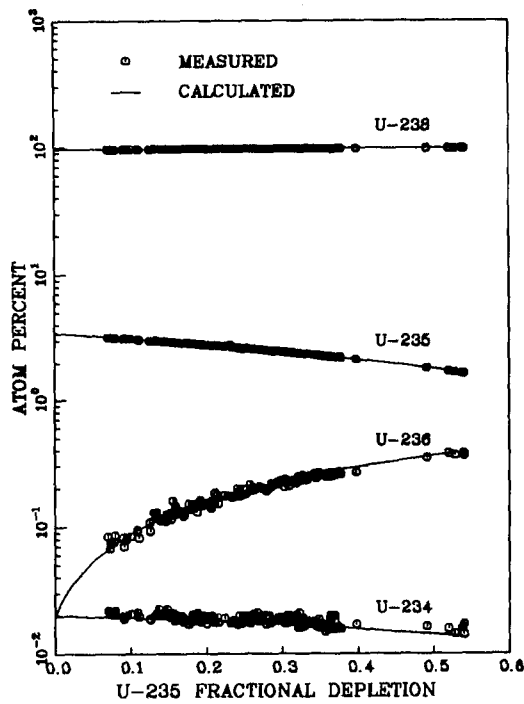

Fig. 5. Comparison between Calculated and Measured Uranium Isotopic Compositions versus U-235 Atom Depletion

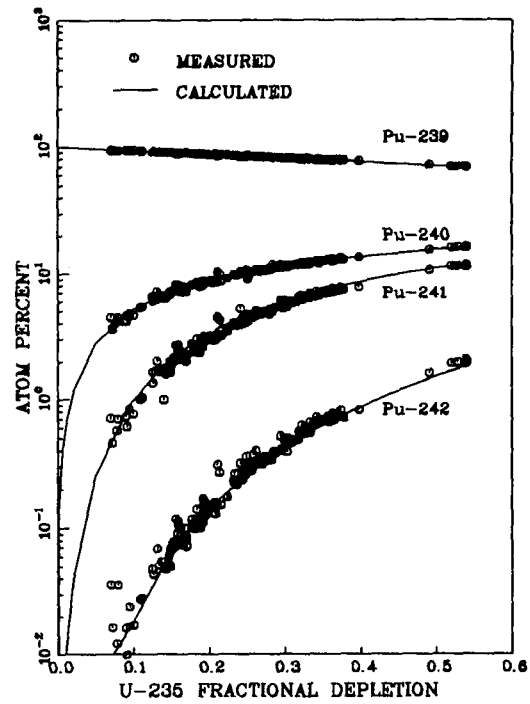

Fig. 6. Comparison between Calculated and Measured Plutonium Isotopic Compositions versus U-235 Atom Depletion

Table 4. Comparison of Calculated Plutonium Isotopic Ratios with Measured Values as a Function of U-235 Depletion.

U-235 Fractional Depletion	Pu-239/Pu-240		Pu-240/Pu-241		Pu-241/Pu-242	
	Calculated	diff. (%) *	Calculated	diff. (%)	Calculated	diff. (%)
0.095	18.77	-2.80	5.56	-3.30	56.71	60.29
0.137	13.53	0.07	3.78	-1.56	37.20	15.82
0.252	8.18	-4.88	2.17	-8.44	17.92	28.00
0.289	7.36	-0.81	1.97	-4.83	15.24	9.72
0.321	6.74	-0.44	1.82	-2.67	13.25	13.25
0.351	6.23	-0.16	1.71	-2.84	11.73	11.61
0.491	4.70	0.86	1.41	-2.76	7.52	13.42
0.538	4.33	-0.92	1.35	-4.26	6.60	11.11

\* ((Calculated/Measured) - 1) × 100 (%)

WIMS-KAERI code as part of an infinite lattice with no extra region. The specifications used in this calculation are summarized in Table 3.

Calculated burnup dependent isotopic inventories of uranium and plutonium are compared with the measured values in Figures 5 and 6, respectively. The isotopic contents are expressed as a function of U-235 atom fractional depletion in the Figures. The calculated values are generally in good agreement with measured results. The Pu-242 atom density is slightly underpredicted, however, at high burnup.

A direct comparison of the calculated and

measured isotopic ratios of plutonium isotopes in some depletion steps is given in Table 4.

The calculated values for Pu-239/Pu-240 are in excellent agreement with measured values, and the values for Pu-240/Pu-241 are also in good agreement relatively. The Pu-241/Pu-242 ratios, however, appear to be overpredicted over the entire burnup range. The overprediction of Pu-241/Pu-242 is from the underprediction for the buildup of Pu-242. The calculated and measured isotopic ratios versus burnup are compared in Figure 7 through 9.

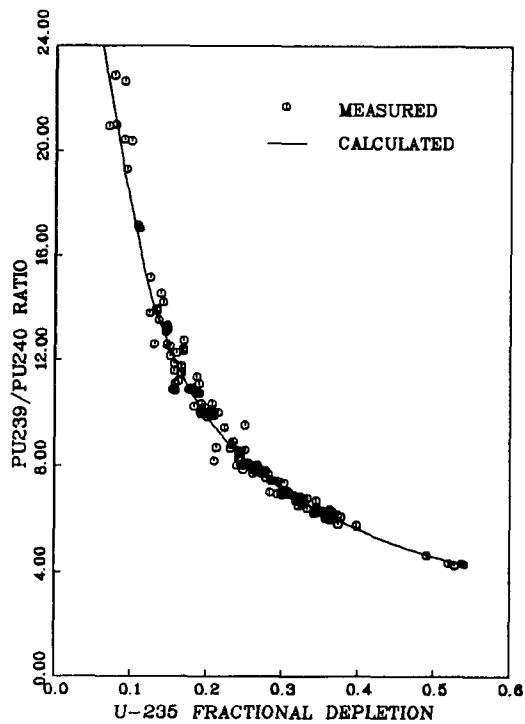

Fig. 7. Comparison between Calculated and Measured Pu-239 to Pu-240 Atom Ratios versus U-235 Atom Depletion

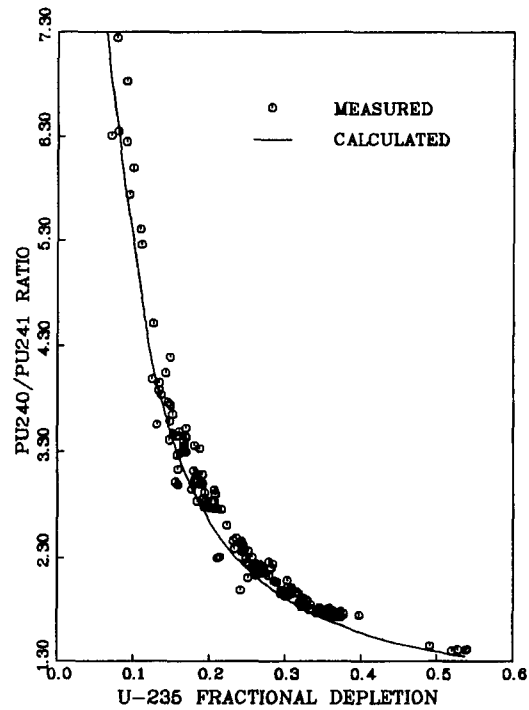

Fig. 8. Comparison between Calculated and Measured Pu-240 to Pu-241 Atom Ratios versus U-235 Atom Depletion

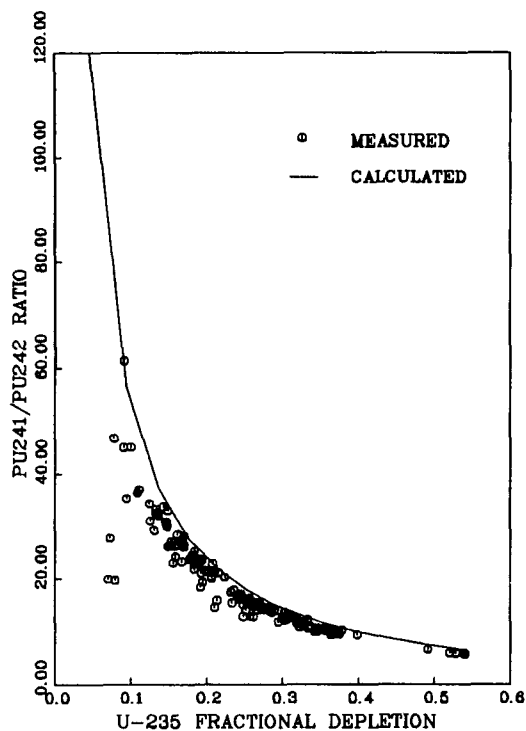

Fig. 9. Comparison between Calculated and Measured Pu-241 to Pu-242 Atom Ratios versus U-235 Atom Depletion

#### 4. Conclusion

In order to provide an up-to-date multigroup cross section library for thermal reactor applications, an ENDF/B-V or IV based 69-group nuclear data library have been generated using the data processing system NJOY. Adequacy of the newly generated data in thermal reactor problems was validated through comparisons of results with experimental values such as critical and depletion data.

The results of the criticals benchmarking using the WIMKAL-89 library with the WIMS-KAERI code indicate consistency and accuracy in analyzing a variety of configurations. There is a tendency for the WIMKAL-88 library to slightly overestimate the  $UO_2$  eigenvalues and under

estimate the metal eigenvalues. The depletion benchmarking shows that use of the WIMKAL-88 gives results that generally compare well with measured isotopic data, although some inconsistencies were observed. Most of the observed discrepancies are within or near experimental uncertainties, or within the limits of accuracy expected from the calculational model such as a simple cell model. Therefore, use of the WIMKAL-88 is recommended in the analysis of water-moderated nuclear reactors.

#### References

1. R.F. Barry, "LEOPARD—A Spectrum Dependent Non-spatial Depletion Code for the IBM-7094", WCAP-3269-26 (1963).
2. C.G. Poncelet, "LASER—A Depletion Program for Lattice Calculations based on MUFT and THERMOS", WCAP-6073 (1966).
3. J.R. Askew et al., "A General Description of the Lattice Code WIMS", Journal of British Nuclear Energy Society, 5, 564 (1966).
4. H.D. Lemmel, "Index of Data Libraries available on Magnetic Tape from the IAEA Nuclear Data Section", IAEA-NDS-7 (1986).
5. R.E. MacFarlane et al., "The NJOY Nuclear Data Processing System", LA-9303-M, Vol.1 (1982).
6. H.R. Kim, "WIMS-KAERI for the Extended KMRR Physics Calculations", KAERI Internal Report (1987).
7. R. Kinsey, "ENDF/B Summary Documentation", BNL-NCS-17541, 3rd Edition (ENDF/B-V) (1979).
8. D. Garber, "ENDF/B Summary Documentation", BNL-17541, 2nd Edition (1975).
9. T. Nakagawa, "Summary of JENDL-2 General Purpose File", JAERI-M 84-103

- (1984).
10. D.E. Cullen et al., "ENDL-84: The Lawrence Livermore National Laboratory Evaluated Nuclear Data Library in ENDF/V Format", IAEA-NDS-11, Rev.4 (1985).
  11. R.E. MacFarlane, "ENDF/B-V Cross Section Library for Reactor Cell Analysis", EPRI-NP-3418 (1984).
  12. Jung-Do Kim et al., "Nuclear Data Evaluation and Group Constant Generation for Reactor Analysis", KAERI/RR-750/88 (1988) (in Korean).
  13. P.W. Davison et al., "Yankee Critical Experiments Measurements on Lattices of Stainless Steel Clad Slightly Enriched Uranium Dioxide Fuel Rods in Light Water", YAEC-94 (1959).
  14. V.E. Grob et al., "Multi-Region Reactor Lattices Studies-Results of Critical Experiments in Loose Lattices of UO<sub>2</sub> Rods in H<sub>2</sub>O", WCAP-1412 (1960).
  15. W.J. Eich et al., "Reactivity and Neutron Flux Studies in Multiregion Loaded Cores", WCAP-1433 (1961).
  16. L.E. Strawbridge et al., "Criticality Calculation for Uniform Water-Moderated Lattices", Nucl. Sci. Eng., 23, 58-73 (1965).
  17. E.G. Taylor, "Critical Experiments for the SAXTON Partial Plutonium Core", WCAP-3385-54 (1965).
  18. T.C. Engelder et al., "Measurement and Analysis of Uniform Lattices of Slightly Enriched UO<sub>2</sub> Moderated by D<sub>2</sub>O-H<sub>2</sub>O Mixtures", BAW-1273 (1963).
  19. A.L. Mackinney et al., "Reactivity Measurements on Unperturbed, Slightly Enriched Uranium Dioxide Lattices", BAN-1199 (1960).
  20. J.R. Brown et al., "Kinetic and Buckling Measurements on Lattices of Slightly Enriched Uranium and UO<sub>2</sub> Rods in Light Water", WAPD-176 (1958).
  21. H. Kouts et al., Proc. Intern. Conf. Peaceful Uses Atomic Energy, 5, 183, United Nations Publications, New York (1956).
  22. H. Kouts et al., "Experimental Studies of Slightly Enriched Uranium Water Moderated Lattices, Part I, 0.600 Inch Diameter Rods" BNL-486 (1957).
  23. H. Kouts et al., Proc. Second Intern. Conf. Peaceful Uses Atomic Energy, 12, 446, United Nations Publication, Geneva (1958).
  24. J. Jedruch et al., "Experimentally Determined Burnup and Spent Fuel Composition of Yankee Core I", WCAP-6071 (1965).
  25. R.J. Nodvik, "Evaluation of Mass Spectrometric and Radiochemical Analysis of Yankee Core I Spent Fuel", WCAP-6068 (1966).
  26. Jung-Do Kim, et al., "Nuclear Data Evaluation and Group Constant Generation for Reactor Analysis KAERI" (to be published).