

A simple 3-phase inverter topology to improve power conversion efficiency

Dang-Minh Phan, Hong-Hee Lee*

School of Electrical Engineering, University of Ulsan

Abstract

Renewable energy sources such as wind and solar power are free and can be easily harvested everywhere. However, one of the biggest problems when using this kind of energy source is how to increase the efficiency of power conversion system. This paper introduces a modified 3-phase inverter in order to increase the power conversion efficiency. By adding 3 bi-directional switches at output of the inverter, the current flow back DC source during zero state is prevented to minimize leakage current, so that the efficiency of whole system is increased. The proposed topology also improves the power quality to satisfy the total harmonics distortion (THD) requirement. In order to verify the effectiveness of the proposed topology, simulation results are carried out using Simulink in MATLAB.

1. Introduction

The conventional 3-phase power inverter is the most popular topology in renewable energy conversion systems. Simple control and easy implementation are two main advantageous features of the inverter. In order to improve the conversion efficiency, there are several modified topologies were introduced, e.g. 3-phase neutral point clamped (NPC) inverter and 3-phase inverter with split DC capacitors [1]. In these modified inverters, the current is prevented to not flow back into the DC bus during zero state; therefore, the leakage current from DC bus terminals to ground will be minimized, which makes the efficiency of whole system to be increased. However, these topologies are complex in term of control and number of devices.

In this paper, a simple 3-phase inverter is presented to improve the conversion system efficiency. By adding 3 bi-directional switches at output of the back-to-back inverter the current flow back to the DC source during zero state is prevented to minimize leakage current, so that the system conversion efficiency is increased. The remained paper is arranged as follows. The principle operation of the proposed topology is presented in Section 2. The control strategy is introduced in Section 3, and the simulation results to verify the effectiveness of the proposed topology is shown in Section 4. Finally, the paper is concluded in Section 5.

2. Operation principle of the proposed inverter

The structure of proposed topology is shown in Fig. 1, which consists of the conventional back-to-back inverter and six additional switches at the output side.

The operation principle of the proposed topology is explained schematically in Fig. 2. During non-zero state, the DC voltage source that is a photovoltaic (PV) system supplies power for the load or grid. In this state, the inductance of output switching ripple filter and line impedance also accumulate energy as shown in Fig. 2a. Next time interval, the inverter operates at the zero state, and the extra switches (ES1-ES3) will be turned ON to connect the output of inverter to the neutral point of the grid. On the other hand, the inductance will release energy, and DC voltage source conducts no current as shown in Fig. 2b.

In addition, due to no current produced by DC source during

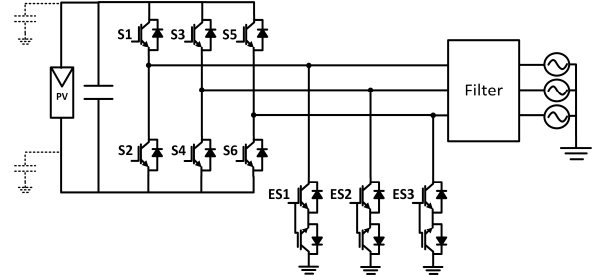

Fig. 1: The proposed topology.

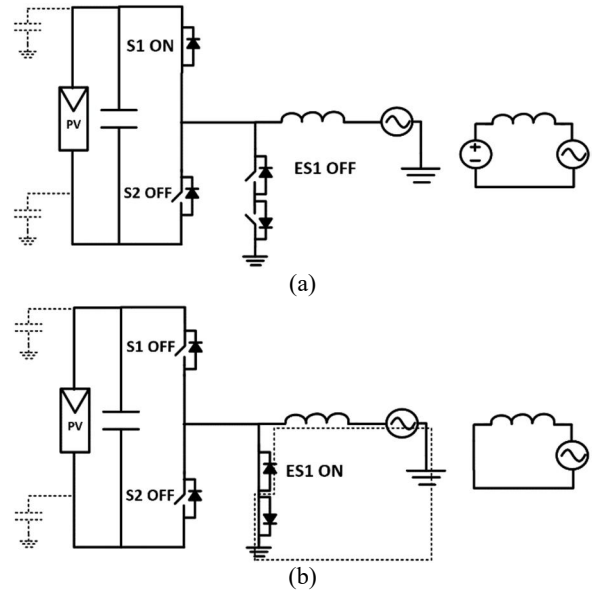

Fig. 2: Operation principle of the inverter. (a) non zero state and (b) zero state.

zero state, the fluctuation of voltage between DC terminals respecting to ground will be minimized. This leads to significantly decrease the leakage current from DC terminals to ground, so that the efficiency of whole system is increased.

3. The control strategy

The control strategy for conventional 3-phase inverter is based on the cross coupling current control as shown in Fig. 3 [2],[3]. The output current of inverter is measured as the feed-back signal. Moreover, the PI controller was used in synchronous rotating frame (dq0) to ensure the instant value of I_d and I_q to be equal to the reference value. Finally, the reference voltage vector in dq0 frame for the space vector modulation (SVM) can be expressed:

$$v_d^* = v_d + L \frac{di_d}{dt} + \omega Li_q \quad (1)$$

$$v_q^* = v_q + L \frac{di_q}{dt} - \omega Li_d \quad (2)$$

where, ω is the fundamental frequency, and L is output ripple filter of the inverter.

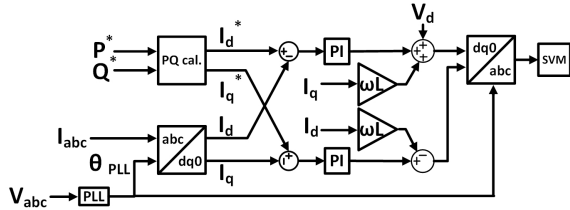

Fig. 3: Cross coupling current control for conventional 3-phase inverter.

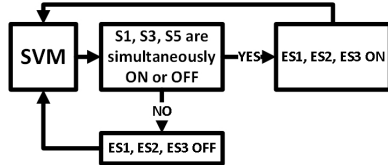

Fig. 4: Control scheme for bi-directional switches.

At a specific interval, if S1, S3 and S5 are simultaneously turned ON; OFF, ES1, ES2 and ES3 will be activated. Otherwise, the state of these bi-directional switches is OFF as shown in Fig. 4.

4. Simulation results

The detail simulation circuit parameters are listed in TABLE I.

Fig. 5a and Fig. 5b present the output voltage and current waveform of the proposed topology when it supplies power for a stand-alone 3-phase load and utility grid, respectively. It can be seen that the good output performances in two modes are obtained with total harmonic distortion (THD) listed in TABLE II.

In order to compare the efficiency between proposed and conventional topology, Fig. 6a and Fig. 6b show the efficiency of systems in the stand-alone mode and grid-connected mode in 3 different power ratings. It is clearly recognized that at any power rating, the proposed topology improve the efficiency.

5. Conclusion

In this paper, the conventional 3-phase inverter was modified by adding 3 bi-directional switches to enhance the system conversion efficiency. During zero state, because of no current produced by DC source, the voltage fluctuation between DC terminals respecting to ground is minimized, so that the efficiency of whole system is increased. In order to verify the effectiveness of the proposed topology, the system is simulated in two modes: stand-alone mode and grid-connected mode. At any power rating, the

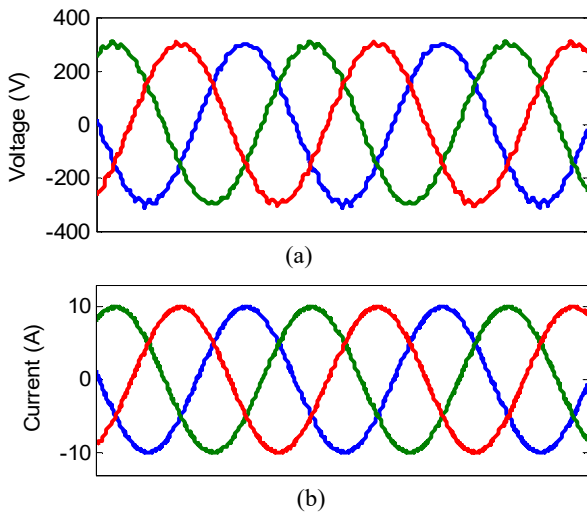
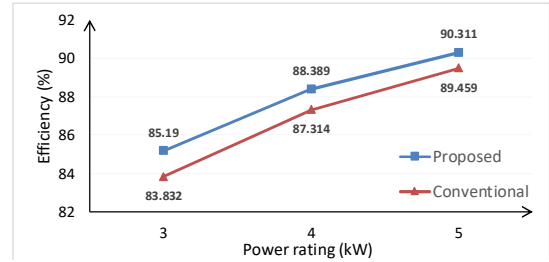
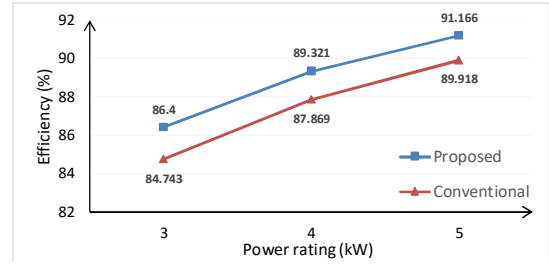

Fig. 5: Output waveform of the proposed topology (a) output voltage in stand-alone mode and (b) output current in grid-connected mode.



(a)



(b)

Fig. 6: Efficiency of two topology at 3 power ratings (a) when they connect to load and (b) under grid connected mode.

TABLE I

PARAMETERS OF SIMULATION.

| Parameter | Unit | Value |
|-------------------------------------|---------|-------|
| Grid fundamental frequency | Hz | 50 |
| Switching frequency | kHz | 10 |
| DC bus voltage | V | 600 |
| Grid voltage V_{rms} | V | 220 |
| Grid connected mode | | |
| Inverter side LCL filter inductance | mH | 5 6 |
| Grid side LCL filter inductance | mH | 0 55 |
| LCL filter capacitance | μ F | 5 5 |
| Stand-alone mode | | |
| L filter | mH | 20 |

TABLE II

THD STATISTICS (A) WHEN THEY CONNECT TO LOAD AND (B) GRID CONNECTED MODE.

| Phase voltage THD (%) | | | | |
|--------------------------|------|------|------|--|
| P_{in} | 5 kW | 4 kW | 3 kW | |
| Proposed topology | 2 5 | 2 35 | 2 88 | |
| 3-phase inverter | 2 61 | 2 38 | 3 02 | |
| Injected current THD (%) | | | | |
| P_{in} | 5 kW | 4 kW | 3 kW | |
| Proposed topology | 0 43 | 0 5 | 0 65 | |
| 3-phase inverter | 0 55 | 0 65 | 0 75 | |

good performance output with low THD is obtained, and the efficiency of the proposed topology is always higher than that of the conventional topology.

Acknowledgement

This work was supported by the National Research Foundation of Korea Grant funded by the Korean Government (2013R1A2A2A01016398).

References

- [1] Tamás Kerekes, "Analysis and Modeling of Transformerless Photovoltaic Inverter Systems", Aalborg University, Institute of Energy Technology, Denmark, August 2009.
- [2] Mirjana Milosevic, "Decoupling Control of d and q Current Components in Three-Phase Voltage Source Inverter", Technical report, Zurich, 2003.
- [3] M.P.Kazmierkowski, L.Malesani, "Current control techniques for three phase voltage-source PWM converters: a survey", Industrial Electronics, IEEE Transactions on Industrial Electronics, Vol. 45, No. 5, Oct.1998., pp. 691 -703.