

RADARGRAMMETRY OF HIGH RESOLUTION SYNTHETIC APERTURE RADAR – A THEORETICAL STUDY

Hoonyol Lee

Department of Geophysics, Kangwon National University, hoonyol@kangwon.ac.kr

ABSTRACT: This paper reports the preliminary results on the study of radargrammetry especially for a high-resolution satellite synthetic aperture radar system. Theoretical configurations for radargrammetry in terms of coverage, orbit selection, incidence angles, height sensitivity of parallax and height resolution of DEM were calculated according to the proposed orbit characteristics and the imaging modes of KOMPSAT-5 SAR. Possible imaging strategies and mission scenarios for coverage versus rapidity are suggested for a future mission dedicated to radargrammetry.

KEY WORDS: KOMPSAT-5, SAR, radargrammetry, orbit

1. INTRODUCTION

Korean people will witness the launch of the KOMPSAT-5 satellite carrying synthetic aperture radar within a couple of years. The SAR system will operate in X-band capable of imaging the earth surface with up to 1m spatial resolution day and night, regardless of weather condition. The proposed orbit and the imaging modes allow obtaining several images of a target with multiple incidence angles so that the topographic elevation can be extracted quantitatively by radargrammetry.

In this paper, the orbit of KOMPSAT-5 and the image modes of SAR are analyzed for radargrammetric applications. The possible configurations and their height sensitivity of parallax and thus the height resolution of digital elevation model are theoretically calculated. Mission scenarios dedicated for radargrammetry are suggested in terms of coverage and rapidity.

2. KOMPSAT-5

2.1 Orbit and Imaging Modes

The proposed orbit of KOMPSAT-5 is a sun-synchronous, dawn-dusk orbit with the mean local time of ascending node (MLTAN) at 06:00 am (KARI, 2007). The mean altitude is 550 km at equator and the inclination angle is approximately 97.6° (Table 1). The satellite will revolve the Earth 15 and 1/28 times per day and takes 28 days to revisit the same ground track after 421 revolutions. The successive orbit distance is 2665 km and the distance between adjacent pass is 95 km at equator.

The KOMPSAT-5 SAR will have three imaging modes: spot, stripmap and scanSAR (Fig. 1). The spot SAR will obtain high-resolution (1 m) image with 5 km swath for 3 seconds for a scene and at least 22 scenes per orbit. The strip map will acquire 3 m resolution image with 30 km swath and the scanSAR will obtain 20 m resolution image with 100 km swath, both for at least 2 minutes per orbit. The look angle of the beam can be steerable so that the ground coverage will be, when measured from nadir,

185 – 490 km (305 km wide) for nominal look and 490-675 km (185km wide) for extended beam steering.

2.2 Incidence Angles

Thanks to the wider coverage of up to 490 km width in a single orbit than the 95-km distance between adjacent passes (at equator), a ground target can be imaged several times with multiple incidence angles, which is required for radargrammetric configuration. For a ground range point at x , with its origin at the nearest nadir of a pass ($n=0$), the incidence angle is periodic with the ground range of $[-47.5 \text{ km}, 47.5 \text{ km}]$ and can be calculated from Fig. 2 and some simple arithmetic as the following set of equations.

Table 1. Orbit elements of KOMPSAT-5. Note the parameters may be changed due to a new launch schedule in May 2010.

Epoch: 2009JUN01 00:00:00 UTC	Mean Orbit (J2000)	Osculating Orbit (J2000)
Semi-Major Axis (km)	6928.11434	6937.46791
Eccentricity	0.001068966	0.001201637
Inclination (deg)	97.597531	97.595674
R.A. of Ascending Node (deg)	339.734883	339.735375
Argument of Perigee (deg)	90.0	67.308762
Mean Anomaly (deg)	270.0	292.740966

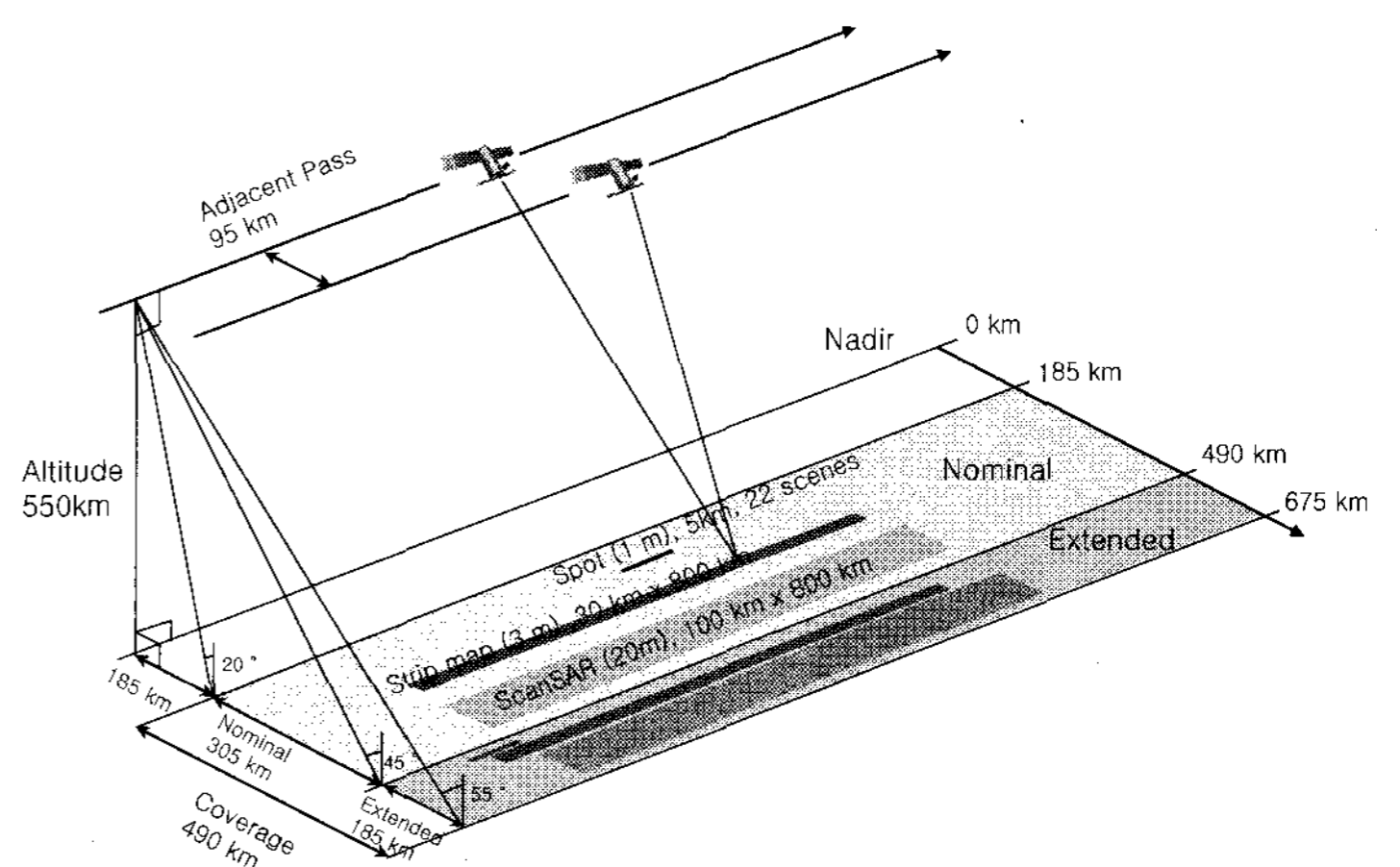

Figure 1. Imaging modes of KOMPSAT-5 SAR.

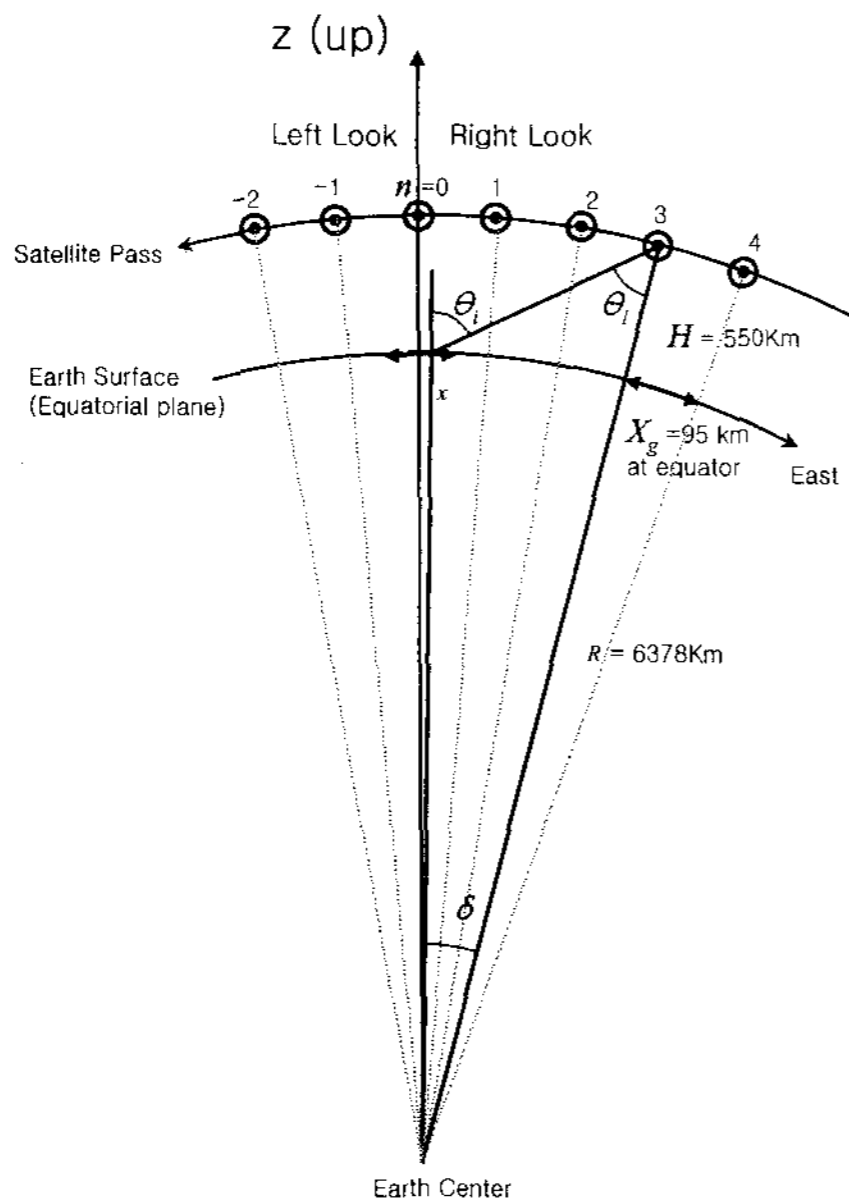

Figure 2. Geometry of a satellite, a target, and the Earth.

$$\begin{aligned}
 R_g &= nX_g - x \\
 \delta &= (nX_g - x) / R \\
 R_s &= \sqrt{R^2 + (R+H)^2 - 2R(R+H)\cos\delta} \\
 \theta_l &= \sin^{-1}(R\sin\delta/R_s) \\
 \theta_i &= \delta + \theta_l
 \end{aligned} \quad (1)$$

where,

R : Earth radius

H : Altitude of satellite

X_g : Ground distance between adjacent passes

n : Pass number from nadir

x : Image location from nadir to east ($|x| < X_g/2$)

θ_i : Incidence angle

Nominal: $20^\circ < \theta_i < 45^\circ$

Extended: $45^\circ < \theta_i < 55^\circ$

θ_l : Look angle

R_g : Ground range

Nominal: $185 \text{ km} < R_g < 490 \text{ km}$

Extended: $490 \text{ km} < R_g < 675 \text{ km}$

R_s : Slant range from radar to target

Fig. 3 shows the incidence angles of radar beam from adjacent passes (pass number n) as a function of the distance x from the nearest nadir. The set of passes relevant to a target are different with the different ground range. At $x=-45$ km, for example, $n=2, 3, 4$ passes are available in nominal mode and $n=5, 6$ passes in extended mode, as is also depicted in Fig. 4(a). At $x=0$ km, $n=2, 3, 4, 5$ (nominal modes) and $6, 7$ (extended modes) are within the coverage (Fig. 4b), while at $x=47.5$ km, $n=3, 4, 5$ (nominal modes) and $6, 7$ (extended modes) passes are available (Fig. 4c).

Imaging in extended mode, as its own name implies, may accompany the reduction of pulse repetition frequency thus reducing the azimuth resolution and producing topographic shadow. Therefore SAR acquisition in extended mode is designed only for an emergency case and the nominal mode operation is conventional. Considering the nominal mode only, two passes ($n=3, 4$) covers the whole ground range while $n=2$ covers from $x=-47.5$ km to 5 km and $n=5$ from -10 km to 47.5 km.

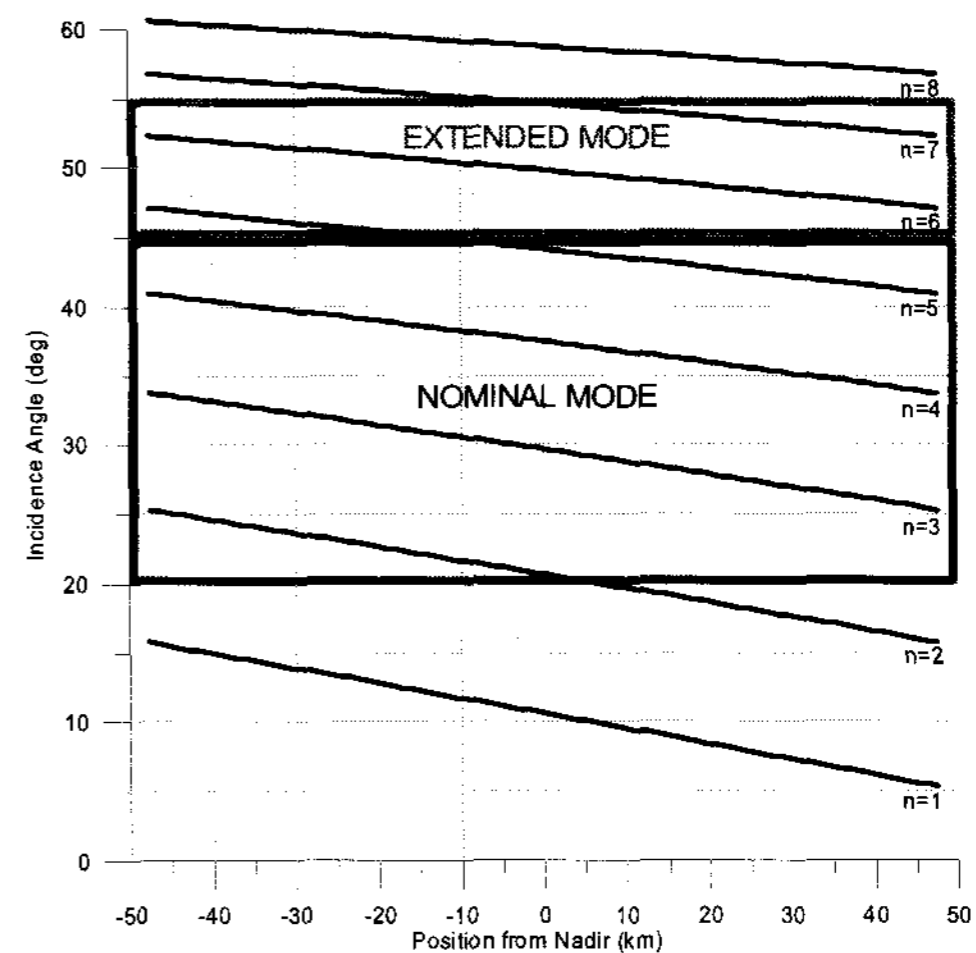
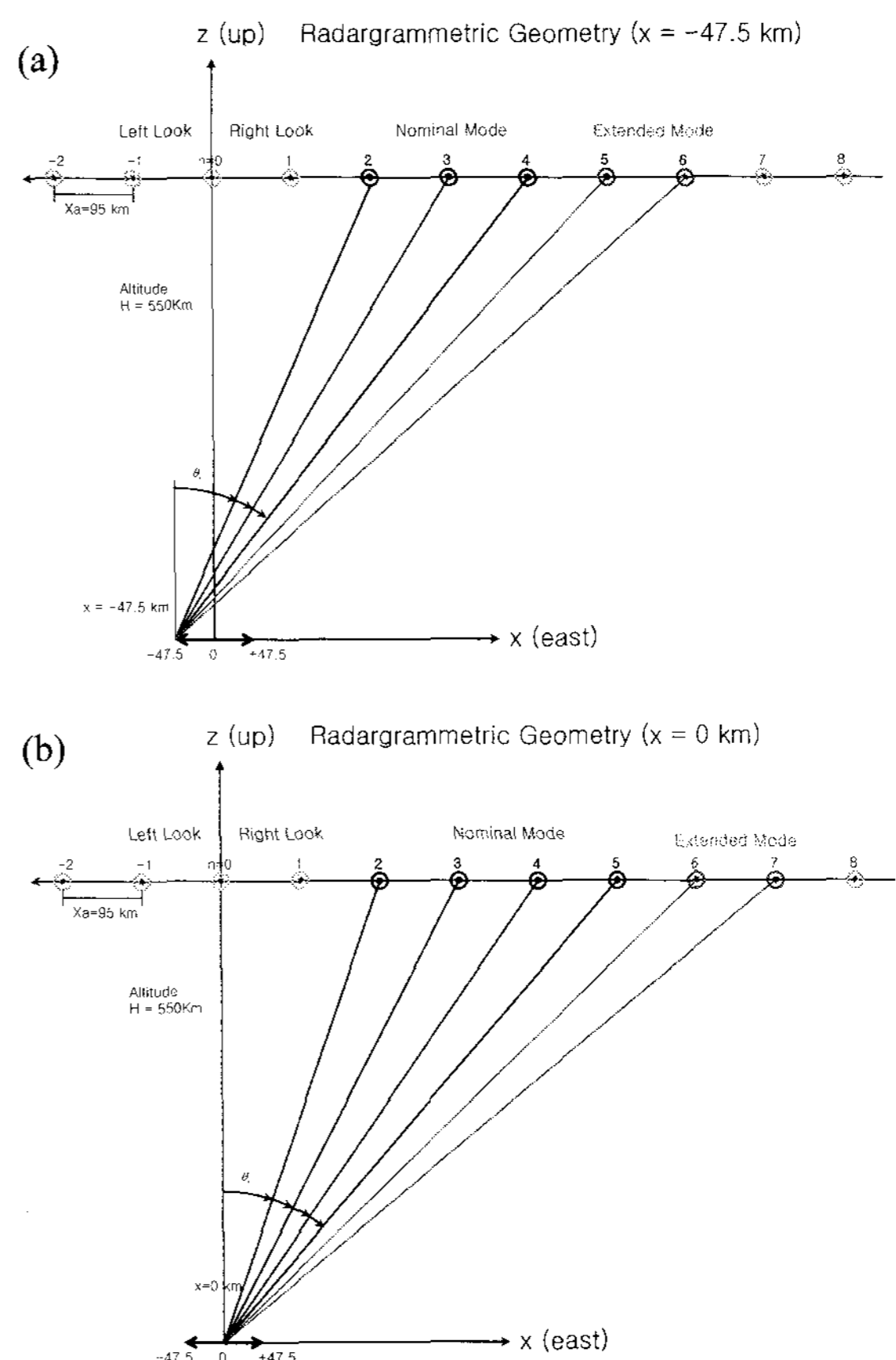

Figure 3. Incidence angles as a function of the distance x from the nearest nadir. n is the pass number counted from the nearest nadir pass of a ground point.



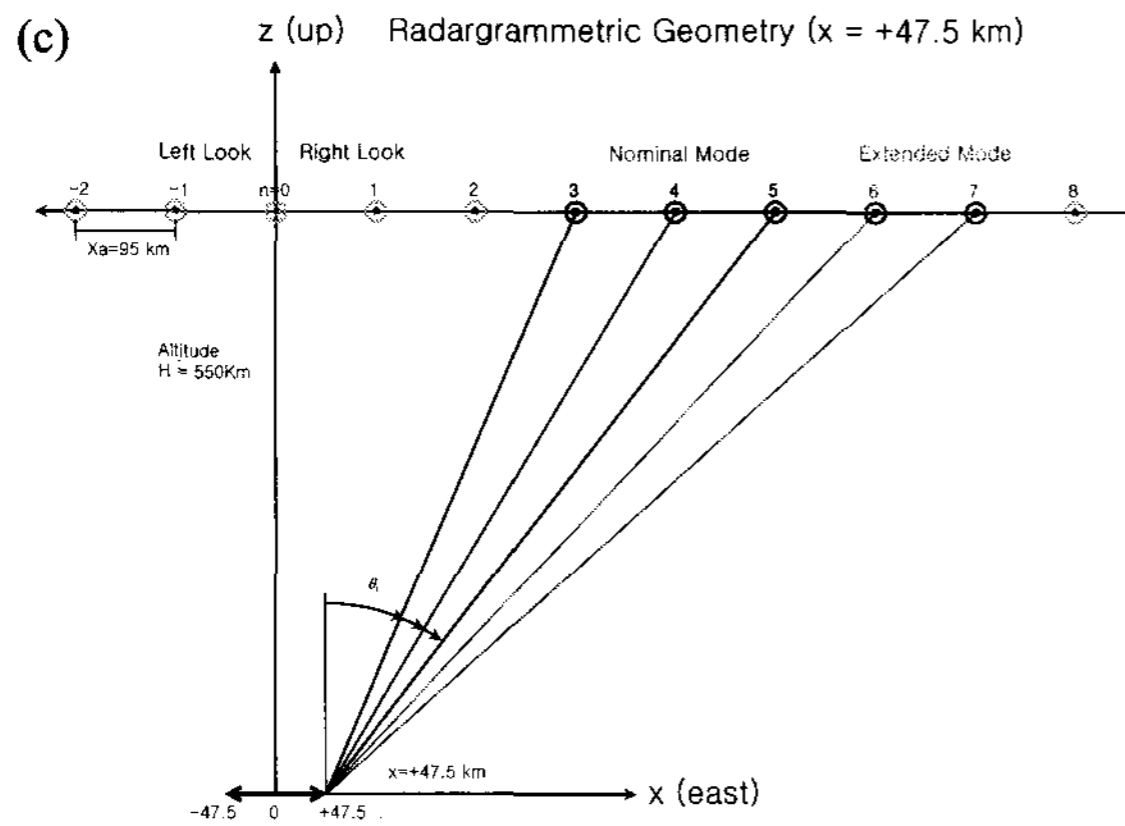

Figure 4. Radargrammetric geometry of a point from adjacent passes. The ground point x is at (a) -47.5 km, (b) 0 km, and (c) 47.5 km away from the nadir.

3. HEIGHT SENSITIVITY OF RADARGRAMMETRY

Radargrammetric orbit geometry can be obtained by two images obtained in the same-side (Fig. 5a) or opposite-side (Fig. 5b) to each other. The Opposite-Side Radargrammetry (OSR) has the height sensitivity higher than the Same-Side Radargrammetry (SSR), but is impractical due to severe topographic distortion and useful in a flat region only (Toutin, 1996). The height sensitivity of parallax and thus the height resolution can be defined by the following set of equations. They apply to both the SSR and OSR by defining a negative incidence angle for the opposite-side orbit.

Parallax:

$$s = h \cot \theta_2 - h \cot \theta_1$$

Height:

$$h = \frac{s}{\cot \theta_2 - \cot \theta_1}$$

Height sensitivity of parallax:

$$\frac{\partial s}{\partial h} = \cot \theta_2 - \cot \theta_1$$

$$= \frac{2 \sin \Delta}{\cos \Delta - \cos 2\theta}$$

$$\text{where } \theta = \frac{\theta_1 + \theta_2}{2},$$

$$\Delta = \theta_2 - \theta_1$$

Nominal: $0 < \Delta < 25^\circ$,

$$20^\circ + \frac{\Delta}{2} < \theta < 45^\circ - \frac{\Delta}{2}$$

Extended: $0 < \Delta < 35^\circ$,

$$20^\circ + \frac{\Delta}{2} < \theta < 55^\circ - \frac{\Delta}{2}$$

Height resolution:

$$\Delta h = \frac{\partial h}{\partial s} \Delta s$$

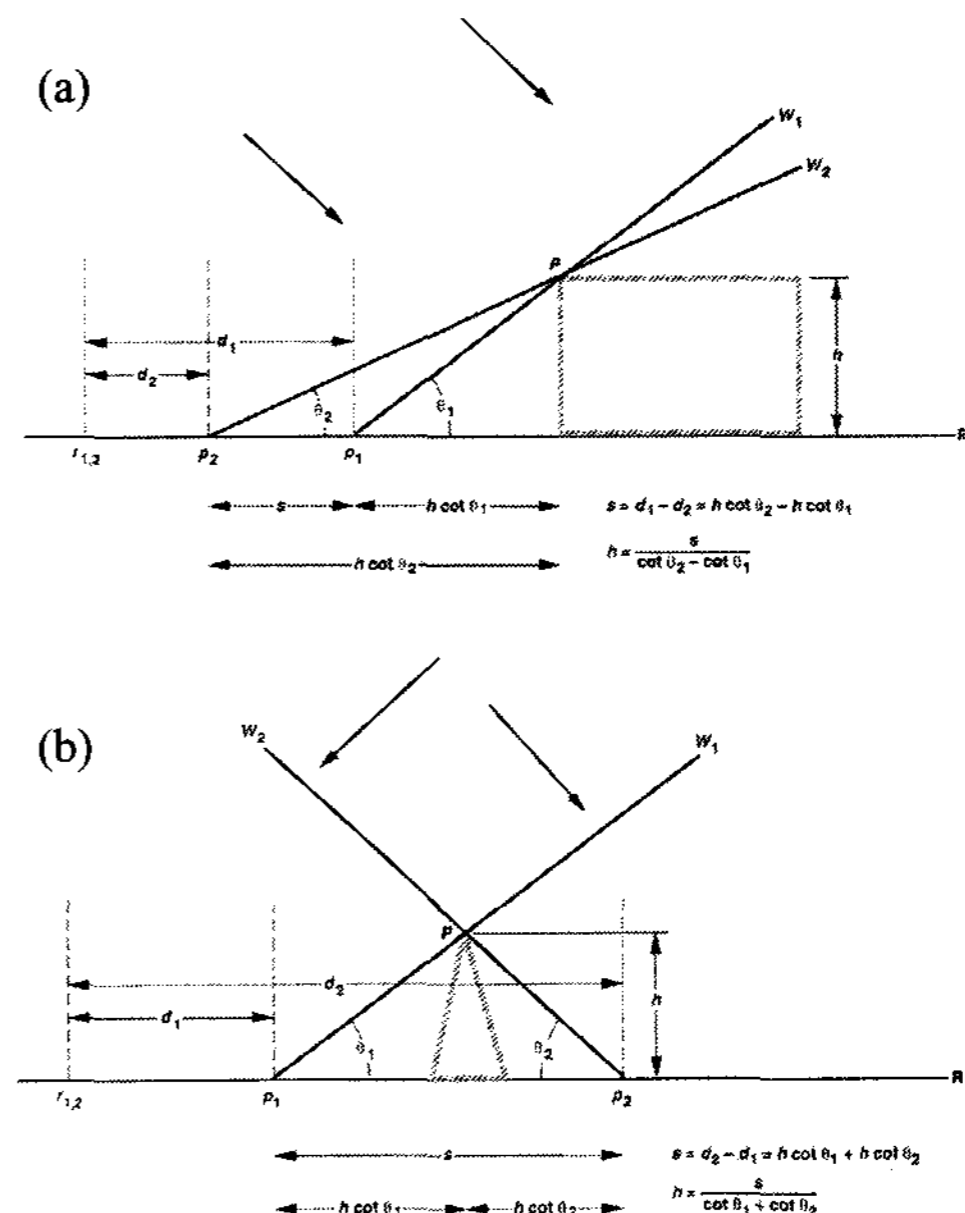

Figure 5. Geometries of radargrammetry of (a) same-side and (b) opposite-side (Ford *et al.*, 1993).

Fig. 6 shows the height sensitivity of parallax and the height resolution as a function of the average incidence angle. The sensitivity decreases with the increase of the average incidence angle and is proportional to the difference in incidence angles. Therefore, a higher difference of incidence angles together with a lower average incidence angle is preferred for higher accuracy of DEM generation. In practical situation, however, the height sensitivity is limited by the topographic distortions such as foreshortening, layover and shadow, and the image resolution during correlation process. Therefore, the value range of the height sensitivity of parallax from 0.1 to 1 for mountainous region is generally acceptable.

Fig. 7 depicts the height sensitivity of parallax and the height resolution as a function of the ground range x of which origin at the nearest nadir. It is shown that the radargrammetric pair with pass numbers 3-2 and 5-3 covers the entire ground range with height sensitivity of 0.6 to 0.9 in one or two days of separation between two images. This radargrammetric pair is recommend for a long term mission dedicated to the complete radargrammetric ground coverage. In an emergency case that rapidity is the highest priority, one can choose any of the radargrammetric pair depicted in Fig. 7.

Note that the calculations given above are true at equator only. The parameters and conditions change significantly in different latitudes. For example, the distance of adjacent passes and the possible orbit combinations are highly dependent on the latitude, as shown in Fig. 8. Especially in the polar region, the distance of adjacent pass shrinks to zero and the images will be rotated between adjacent passes.

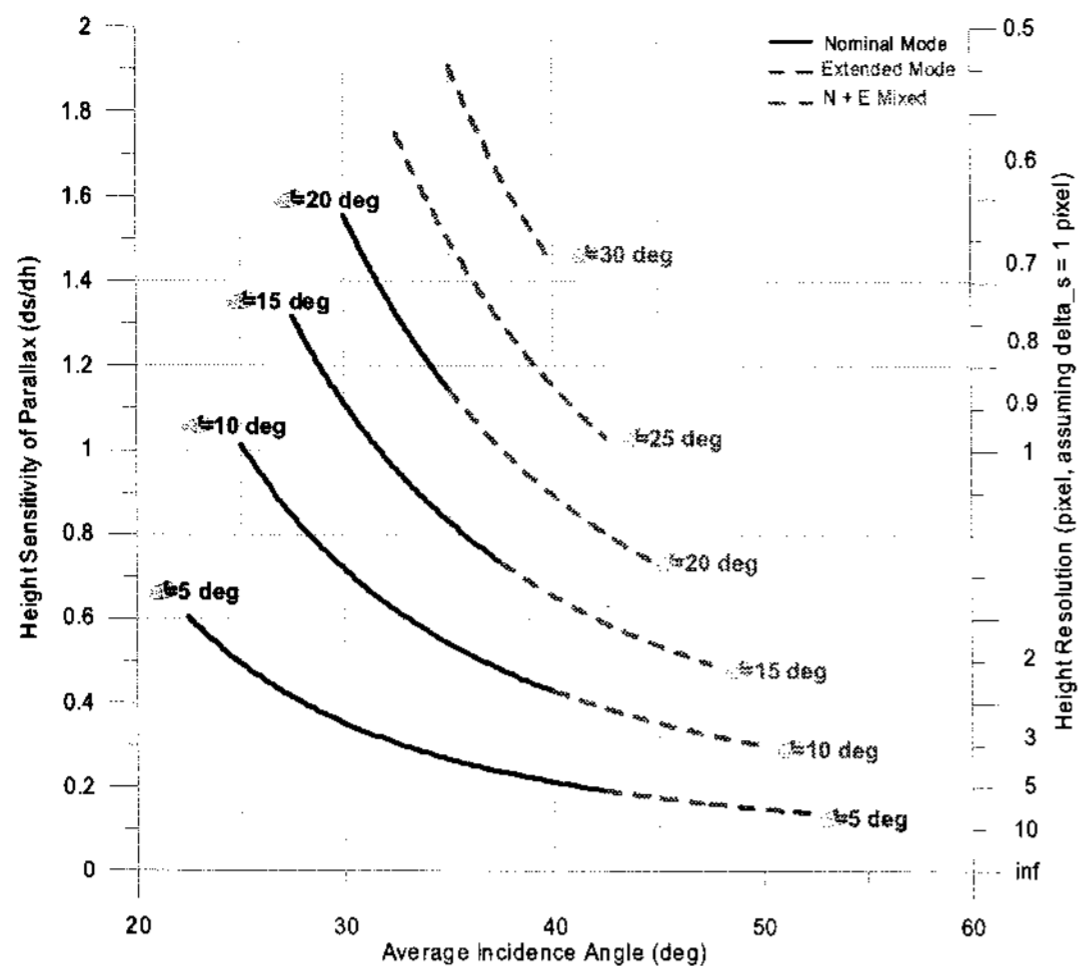

Figure 6. The height sensitivity of parallax and the height resolution as a function of the average incidence angle. The delta is the difference of incidence angle between the radargrammetric image pair.

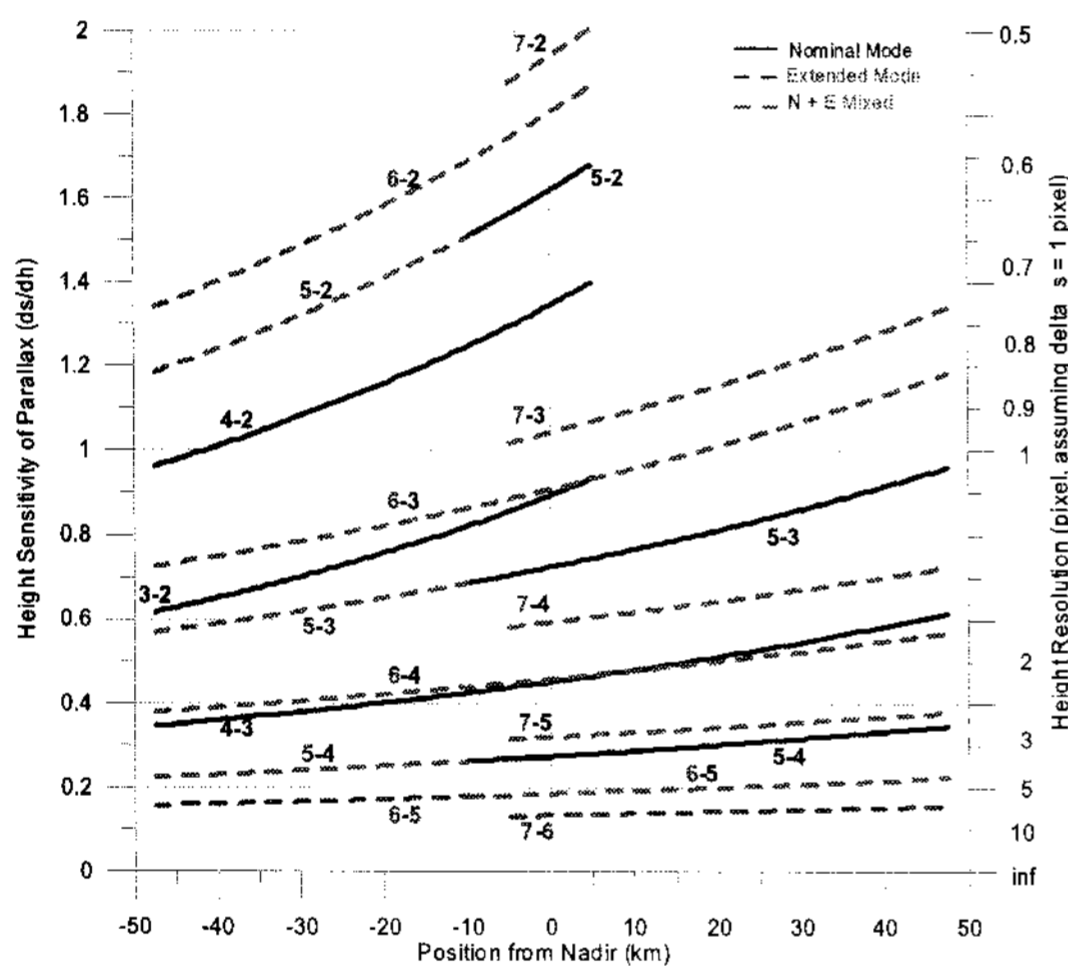

Figure 7. The height sensitivity of parallax and the height resolution of radargrammetric image pairs as a function of the position from nadir. A pair of pass numbers is given on each line.

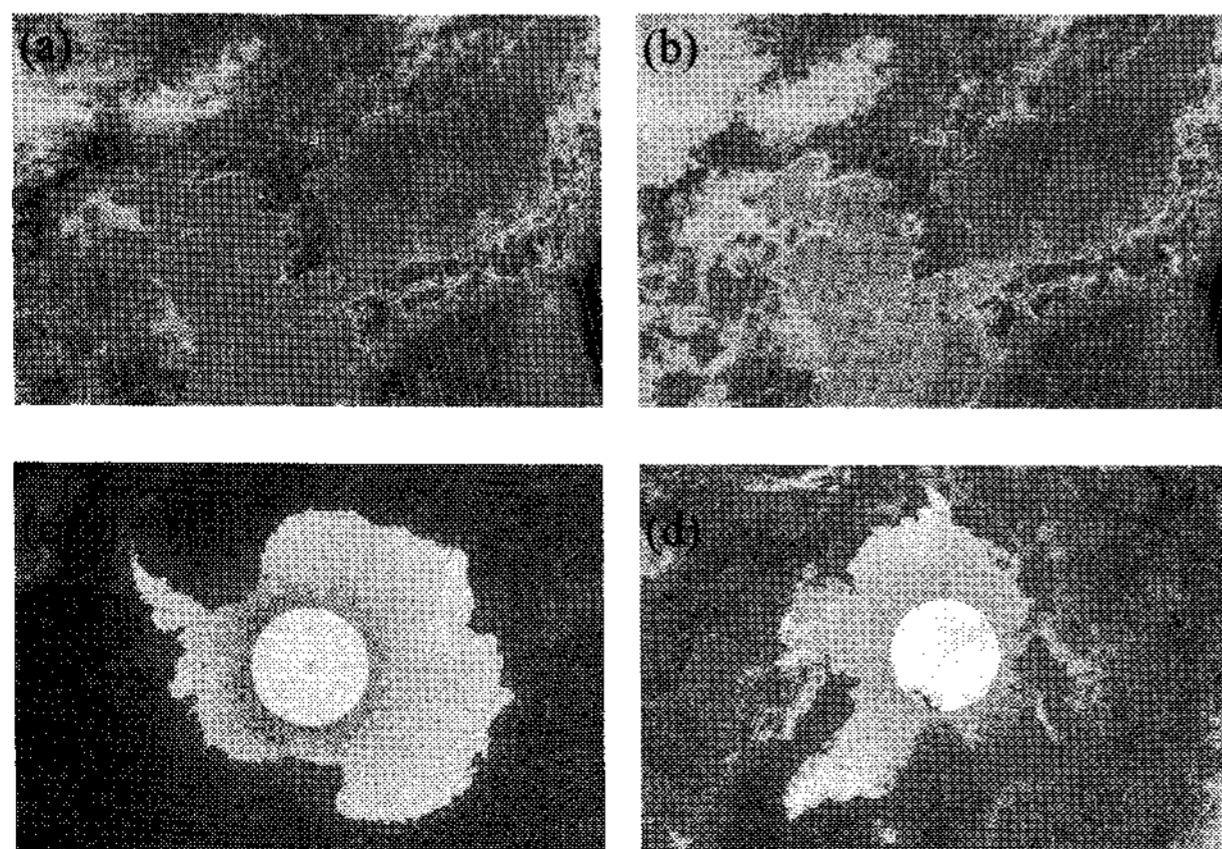

Figure 8. KOMPSAT-5 passes of (a) ascending and (b) descending around Korea, (c) Arctic, and (d) Antarctic. This figure is generated by the STK software version 8.1.

4. CONCLUSION

The orbit characteristics of KOMPSAT-5 and the imaging modes of the SAR are analyzed from the radargrammetric point of view. It is proved that the same-side radargrammetric pairs with pass numbers 5-3 and 3-2, where the pass is numbered from the nearest nadir of a ground target, can be used for a future mission dedicated to the complete coverage of the ground for radargrammetry. This radargrammetric configuration will produce the digital elevation model of the height sensitivity of parallax from 0.6 to 0.9 and the height resolution that corresponds to 1-2 pixels (or, spatial resolution). Wider selection of radargrammetric image pair, both from nominal and extended mode, are theoretically given from this research though their quality of DEM may be less favourable in terms of height sensitivity and image correlation process. Combination of ascending/descending and left/right-looking imaging modes may provide more opportunity for radargrammetry as well. It is worth noting that all calculations in this paper are at equator and the parameters are highly latitude-dependent. The analysis of a global-wide radargrammetric configuration, including the polar regions as extreme cases, remain as an ongoing research.

ACKNOWLEDGMENTS

This research is supported by Korea Aerospace Research Institute (KARI). I appreciate Analytical Graphics, Inc. for providing the STK version 8.1, and Dr. Jae Cheol Yoon (KARI) and Ms. So Young Jang (KNU) for their help and valuable discussion.

REFERENCES

- Ford, J. P., J. J. Plaut, C. M. Weitz, T. G. Farr, D. A. Senske, E. R. Stofan, G. Michaels, and T. J. Parker, 1993. *Guide to Magellan Image Interpretation*, NASA, JPL.
- KARI, 2007. Summary of Mission and Concept of Operations, KOMPSAT-5 SAR User Group Workshop, Jeju, 29 May 2007 (in PPT file format).
- Lee, H., J. V. Morgan, and M. R. Warner, 2003. Radargrammetry of opposite-side stereo Magellan synthetic aperture radar on Venus, *IGARSS'03*, Toulouse, France.
- Toutin, T., 1996. Opposite-side ERS-1 SAR Stereo mapping over rolling topography, *IEEE Transactions on Geoscience and Remote Sensing*, 34(2), pp. 543-549.