

Characterization of ZnO for Transparent Thin Film Transistor by Injection Type Delivery System of ALD

Woon-Seop Choi*

School of Display Engineering, Hoseo University, Asan-city, Chungnam, Korea

Phone: 82-41-540-5924, E-mail: wschoi@hoseo.edu

Keywords : ZnO, ALD, TFT

Abstract

ZnO nano film for transparent thin film transistors is prepared by injection type source delivery system of atomic layer deposition. By using this delivery system the source delivery pulse time can dramatically be reduced to 0.005s in ALD system. ZnO nanofilms obtained at 150°C are characterized.

1. Introduction

Organic molecular thin film transistor have been widely studied due to their potential for applications related to large area, low-cost electronics and their compatibility with flexible substrate.[1] The carrier mobilities observed for OTFT fabricated from pentacene are comparable with those of amorphous silicon and have attractive interest. Recently, ZnO draws much attention due to the interesting characteristics such as piezoelectric, ferroelectric, and n-type conductivity.[2] ZnO nanofilm exhibits wurtzite structure with a wide band gap of 3.35eV. ZnO film can be prepared as a crystalline material on various substrates, such as glasses and plastics. The preparation methods for nano ZnO film are magnetron sputtering, pulse laser deposition, chemical solution deposition, and molecular beam epitaxy.[3,4] Atomic layer deposition (ALD) for semiconductor industry is used for the fabrication of ZnO film due to the easy control of thickness and improved film quality at relatively low temperature.

Recently, plasma enhanced (PE) ALD with show head reactor and ALD with traveling-wave reactor were used for ZnO film fabrication on silicon wafer by using plasma and water as reactants, respectively.[5,6]

In this paper, we prepare and characterize ZnO nanofilm by injection type delivery system of PEALD

to investigate the effect of naonfilm quality and prove low temperature process for the compatibility of flexible substrates. By using injection type source delivery system reaction time can be reduced and source materials can be directly used as a concentrated state for the process. The study on the transparent ZnO transistors with different gate insulator materials will be carried out.

2. Experimental

ZnO films were deposited on 4" p-type silicon wafer and 100X100mm glass after cleansing by ALD using injection type source delivery system as shown in Fig. 1 at the temperature of 100 C and 150 C, respectively.

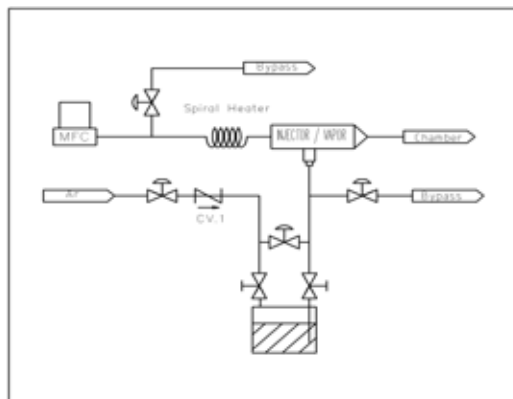

Fig. 1 Schematic diagram of injector type source delivery system for PEALD

As a source of Zn diethylzinc was used. Oxygen plasma and water were used as oxygen precursors for

ZnO fabrication. The reactor pressure was maintained 0.8 Torr with the Ar purging of 100 sccm. During the reaction diethylzinc and oxygen plasma were sequentially injected into the reactor chamber to form ZnO monolayer on the substrate. ALD cycle consisted of the injection of diethylzinc for 0.005s, Ar for 3sec, O₂ gas for 0.5sec, and additional 2sec with rf power of 80W, and final gas purge for 10sec. ALD cycle with water consisted of the similar procedure except oxygen and plasma.

3. Results and Discussion

Generally, source delivery systems for ALD are bubbler types with and without carriers. The point for selection source delivery type is vapor pressure of the precursor. These delivery system can be used for high vapor pressure and mid. vapor pressure sources. Injector type source delivery system can be used for not only above mentioned ALD sources, but low vapor pressure source. One of the reasons for choosing injector type source in this experiment is very short source delivery time. Very short injection time of 0.005 s for precursor delivery was chosen and ZnO film can successfully be fabricated on substrates.

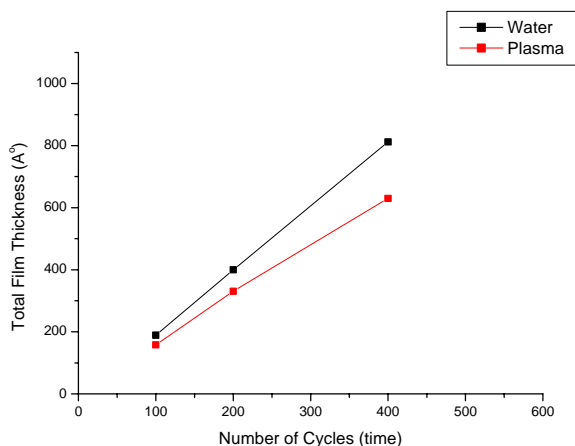

Fig. 2 Total growth film thickness of ZnO by oxygen sources with cycles.

Fig.2 shows the total ZnO film thickness with the number of cycles. The average growth rate was

relatively normal about 2.0 Å/cycle. Comparing water and oxygen plasma as reactants water shows a little higher deposition rate, however, the process condition of plasma treatments affect on the film growth rate. If the process power and time is increased similar deposition rate can be obtained.

The growth rate of nanofilm (average film thickness per cycle) was examined as a function of precursor pulse time as shown in Fig. 3. When the pulse time varied with 0.002 to 0.05, the average growth rate is almost constant. Therefore, we found that the source delivery pulse time can dramatically be reduced in ALD system to 0.002s. Nanofilm thickness was measured as a function of oxygen pulse time. We found that there was an optimum oxygen pulse time for the plasma and film growth. The average growth rate was relatively normal about 2.0 ~ 2.2 Å/cycle comparing general ALD methods.

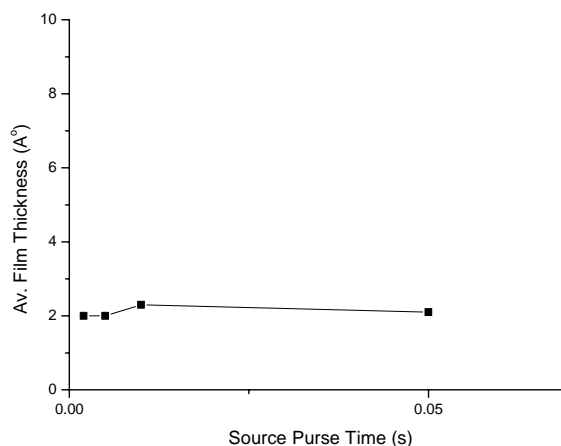

Fig. 3. Average growth rate of ZnO by source pulse time with water as oxygen source.

Fig. 4 shows the effect of substrate temperature on average film growth. As the temperature increases over 200°C, the average growth rate rapidly decreases. Therefore, the processing temperature around 150°C is suitable for ZnO film fabrication by ALD. By increasing injection pulse time and temperature growth rate can be increased. It is said that the growth rate of oxide film by ALD is likely to be determined by the precursor rather than the oxidant because the molecular size of precursor is larger than that of the reactants.

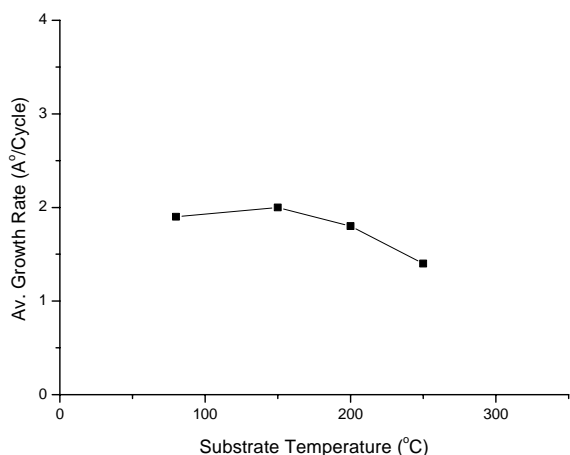

Fig 4. Effect of substrate temperature on ZnO film growth rate.

The crystallographic orientation of prepared ZnO film at 150°C was examined by an X-ray diffractometer (XRD). Polycrystalline structure of ZnO film was obtained as shown in Fig. 5. The growth of ZnO thin film shows (002) direction preferred orientation. It is because that is the most thermodynamically favorable growth direction due to the low surface energy of the (002) plane. The c-axis of hexagonal wurtzite grains of ZnO is arranged perpendicular to the substrate.

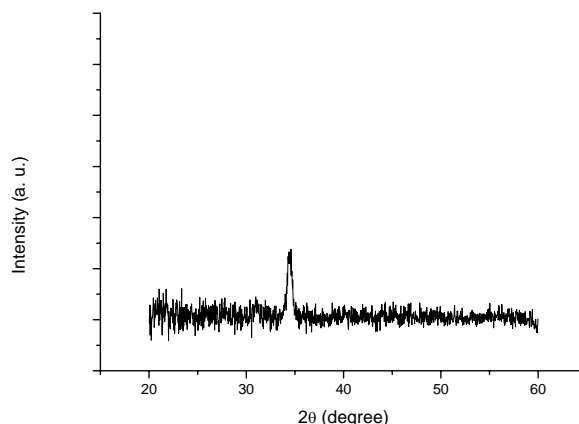

Fig. 5. XRD pattern of ZnO film using water (above) and plasma (below) as oxygen sources

Even though the process temperature was relatively low at 150°C the (002) orientation is dominant. Previous result showed they obtained (002) orientation above 230°C for water as a reactant. [6] Two major peaks in water oxidant are (100) and (002). No (101) crystal structure is observed in this experiment. In case of oxygen plasma as a reactant, the <002> orientation is favorable growth direction like other report. We obtained the same result as a quite low processing temperature at 150°C comparing above 230 °C.

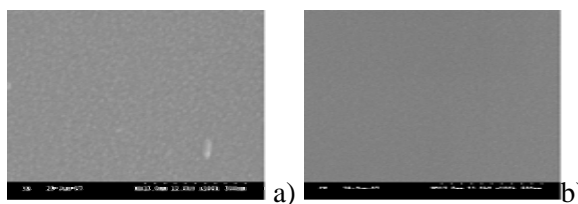
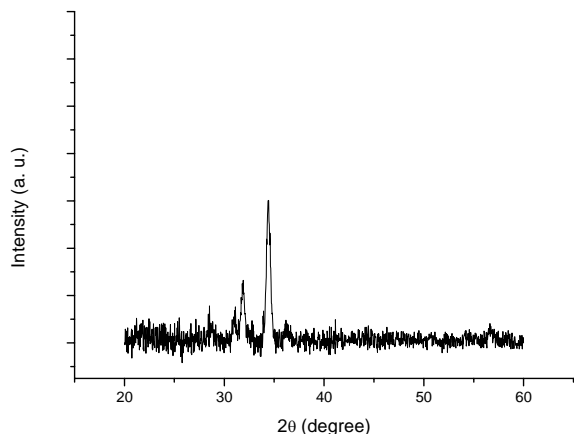

Fig. 6. SEM Images of ZnO film; a, water b. oxygen plasma as reactants

Fig. 6 shows the SEM images of ZnO film as 400 cycles with water and 200 cycles with oxygen plasma as reactants, respectively. Dense thin film and smooth surface can be obtained by ALD technology. The crystalline surface can clearly be shown with the increasing number of cycles.

In order to investigate chemical bonding status in ZnO film, sample was sputtered by Ar in X-ray photoelectron spectroscopy (XPS). Fig. 7 shows two mayor peaks that correspond to bindin energy of 1022eV of Zn 2p_{3/2} and 1044eV of Zn 2p₁. All Zn atoms are in Zn²⁺ state in ZnO film due to no metallic Zn bond in XPS spectra. XPS spectra of ZnO film prepared with oxygen plasma and with water as reactants are almost the same. However, The compositions of Zn:O are slightly different such as 53.44:46.56 for oxygen plasma and 52.09:47.91 for water, respactively.

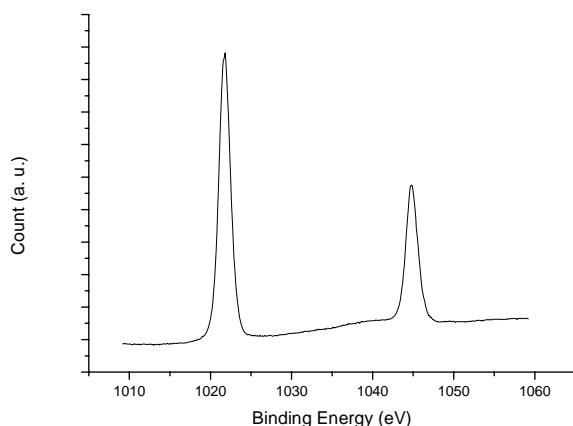

Fig. 7 XPS spectra of ZnO film prepared with oxygen plasma and water as reactants.

4. Summary

With injection type source delivery system very short injection time of 0.005 s for precursor delivery was chosen and ZnO film can successfully be fabricated on substrates. ZnO thin film preferred (002) crystal orientation at relatively low processing temperature. All Zn atoms that are in Zn²⁺ state in ZnO film are confirmed by XPS.

Acknowledgements

This work was supported by Regional Innovation Center (RIC) at Hoseo University.

5. References

- [1] S.F. Nelson, Y-Y Lin, D.J. Gundlach, T.N. Jackson, *Appl. Phys. Lett.* **72**, 1854 (1998).
- [2] J. Hue and G. Gordon, *J. Appl. Phys.*, **71**, 880 (1992)
- [3] P.F Carcia, R.S. McLean, M.H. Reilly, G. Nenus, Jr., *Appl. Phys. Lett.*, **82**, 1117 (2003)
- [4] Y. Ohya, T. Niwa, T. Ban, V. Takahashi, *Jpn. J. Appl. Phys., Part 1*, **40**, 297 (2001)
- [5] S-H K Park, C-S Hwang, H-S Kwack, J-H Lee, H.Y. Vhu, *Electrochem and Solid-state Letters*, **9**(10), G229 (2006)
- [6] S.K. Kim, C.S. Hwang, S-H K. Park, S.J. Yun, *Thin Solid Films*, **478**, 103 (2005)