

0.0: Recent Progress in WV Films – OCB-WV –

Hiroyuki Mori

Flat Panel Display Research Laboratories
Fuji Photo Film Co., Ltd.

210 Nakanuma, Minamiashigara, Kanagawa 250-0193 JAPAN

Abstract: The WV film successfully enlarged the field of view of the TN mode and made TN popular for larger size applications such as PC monitors. The hybrid alignment of the PDM (polymerized discotic material) layer is also suited for the OCB mode, which is promising as a next-generation LCD-TV because of fast panel response and a wide viewing angle. This paper describes recent technological progress in WV films, especially for OCB.

Keywords: polymerized discotic material; biaxial TAC film; viewing angle; moving picture quality; TN; OCB; WV film

1. Introduction

The viewing angle performance of LCDs is one of the major issues when LCDs are competing with other FPDs for large sized TVs. However, this viewing angle problem is becoming less significant with the technological progress of panel structures and optical compensation films¹⁻⁴. The main role of optical compensation films is to optically compensate the black-state liquid crystal layer and to minimize off-axis light leakage from cross Nicol polarizers^{5, 6}, so that the contrast ratio at oblique incidence is increased.

As still image quality becomes sufficiently improved, moving picture quality of LCDs draws much attention recently. Slow moving picture response of LCD-TVs causes motion blur. This problem has two factors; the hold-type driving method and the electro-optical response time of the liquid crystal layer. By changing the hold-type driving method to an impulsive driving method, the motion blur can be reduced. Such methods include the blinking backlight method and the black level insertion method⁷⁻¹⁰. To increase the efficiency of light usage at the same time, the gray level insertion method was also proposed. To speed up the reorientation process of the liquid crystal layer, a variety of overdriving methods are in use. However, even with these desperate efforts, CRT-like moving picture quality seems an unreachable target if conventional LCD-TV modes are pursued because the electro-optical response time of the liquid crystal layer sets the response time limit.

To simultaneously solve the viewing angle problem and the response time problem, OCB (optically compensated bend) is very promising. To make OCB-TVs commercially feasible, there have been lots of obstacles to overcome. One of the key technologies is the development of an optical compensation film for OCB.

This paper describes the recent technological progress in optical compensation films, especially for OCB.

2. What Is OCB?

The OCB cell, a.k.a. the pi-cell or bend cell, was first proposed by Bos *et. al.* in 1984¹¹, having a fast relaxation time and a large cone of view. The unique and symmetrical director configuration of the pi-cell is the origin of these features. When applied voltage is changed, no torque is applied to the local director in the pi-cell although other nematic LCD modes generally has a backflow effect that causes a backwards torque on the local director. The quick director relaxation gives fast response time. The symmetrical director configuration self-compensates its birefringence.

However, there are two main obstacles that must be overcome to develop OCB-LCDs. One is related to the splay to bend transition, as shown in Fig. 1. The rubbing directions on the alignment layers are parallel to each other, giving a splay alignment structure with no voltage applied. It takes time to change the alignment structure from splay to bend because there involves an energy barrier. The long transition time is a problem as a commercial display. To reduce the transition time to a practical level, it was shown that creating twist domains using fringe field facilitates the splay to bend transition¹².

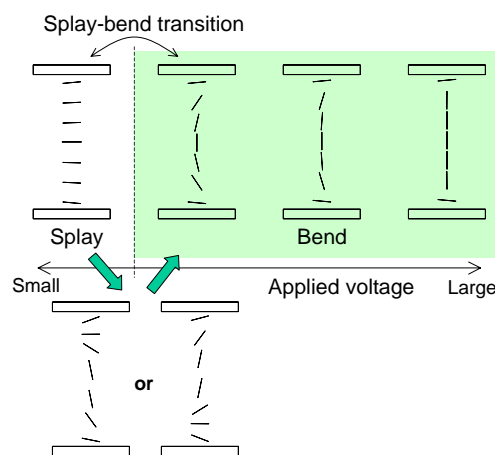

Figure 1. Splay to bend transition of the pi-cell.

The other obstacle is related to the optical performance. The on-axis CR (contrast ratio) of the pi-cell is low when uncompensated because the residual retardation of the pi-cell leaks some amount of light even at sufficiently high voltages. The viewing angle performance was also poor. To

improve the optical performance, use of optical compensation films was proposed^{13), 14)}. However, conventional compensation films obtained by stretching gave unsatisfactory improvement. The pi-cell required three-dimensional optical compensation.

3. Optical Compensation of OCB

The idea of optical compensation of OCB is to use the OCB-WV film that three-dimensionally compensates the birefringence of the black-state pi-cell¹⁵⁾, as illustrated in Fig. 2 (idealized and simplified explanation). The OCB-WV is composed of a PDM layer coated on a biaxial TAC film. The on-axis retardation of the PDM layers in the OCB-WV films compensates the on-axis retardation of the black-state pi-cell. The PDM layer has a hybrid alignment structure that matches the LC alignment structure of half of the pi-cell. The slow axis of the biaxial film is made parallel to the transmittance axis of polarizer to suppress light leakage from polarizer at oblique incidence. A pair of OCB-WV films on both sides of the cell optically compensates the whole pi-cell and minimizes light leakage at oblique incident angles, giving excellent viewing angle characteristics.

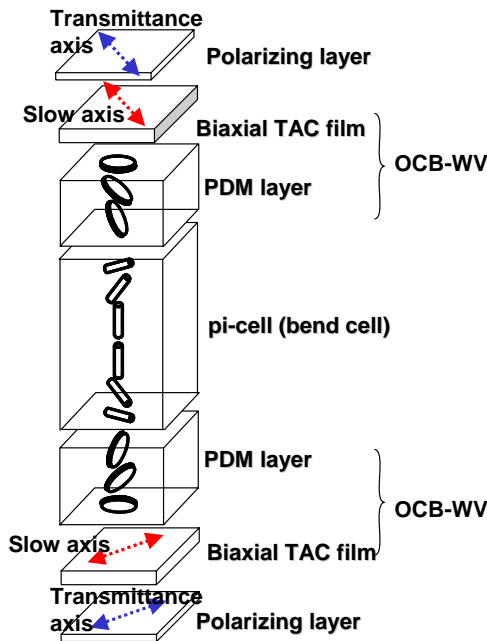

Figure 2. Idealized and simplified explanation of optical compensation for OCB.

A calculated iso-CR contour is shown in Fig. 3. The area of the high CR is very wide. Off-axis color shift is also markedly improved. These results show great promise as large sized LCD-TVs.

4. Structure of OCB-WV

Figure 4 shows the idealized and simplified structure of OCB-WV, which is similar to that of the WV film for TN¹⁶⁾. An alignment layer is coated on a biaxial TAC film. The in-plane slow axis of the biaxial film is in the lateral

direction of the film roll. After orientation treatment in the 45-degree direction of the film roll, the discotic material layer is coated on the alignment layer. The discotic material used is one of the triphenylene derivatives with six cross-linkable groups in all the six side chains. The discotic material layer is aligned in a hybrid way with the director continuously changing in the thickness direction. After taking on a hybrid alignment, the discotic material layer is polymerized by UV cure.

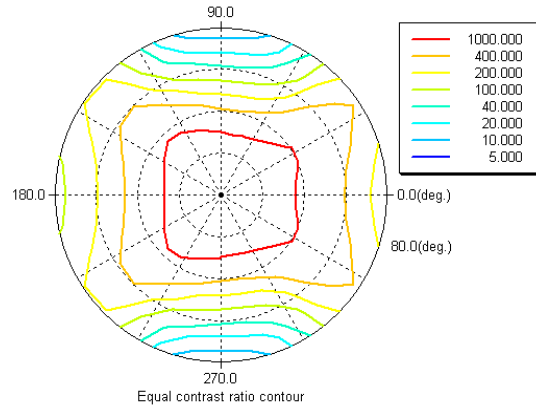

Figure 3. Calculated iso-CR contour for the OCB-LCD compensated with OCB-WV.

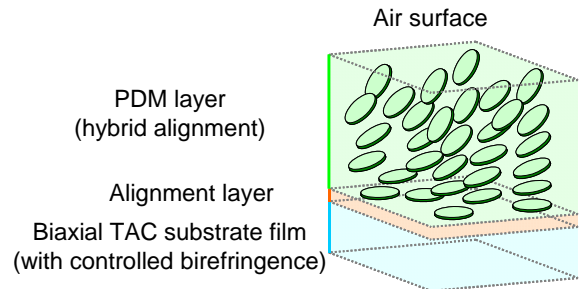

Figure 4. Structure of OCB-WV (idealized and simplified model).

The obtained OCB-WV film is directly attached on a PVA-based polarizing layer in a roll-to-roll polarizer manufacturing process while the other side of the polarizing layer is laminated with a protective TAC film. This unified structure makes the polarizer thin and gives durability. Since the transmittance axis is in the lateral direction of the film roll, the in-plane slow axis of the biaxial TAC film is parallel to the transmittance axis of the polarizing layer. And the orientation direction of the PDM layer makes an angle of 45 degrees with the transmittance axis of the polarizer.

5. Biaxial TAC Film Substrate for OCB-WV

The biaxial TAC film used as a substrate for OCB-WV requires large in-plane retardation, R_e , and out-of-plane retardation, R_{th} , values, compared with usual TAC films. A large R_e value is for suppressing off-axis light leakage from crossed polarizers. And a large R_{th} value is for optical

compensation of part of the black-state pi-cell. To obtain large birefringence for a TAC film, we needed a breakthrough because TAC usually gives very small birefringence due to the polymer structure with side chains almost perpendicular to the main chain.

To increase birefringence, an additive, which gives large optical anisotropy, is added inside the TAC film, as illustrated in Fig. 5. In the solvent casting process of manufacturing a TAC film, TAC polymers orient in plane during drying solvent. The additive tends to align parallel to the TAC main chain. This causes in-plane orientation of the additive molecules, increasing the Rth value. And tenter stretching gives a large Re value in the lateral direction of the TAC film roll. These technologies have allowed us to develop a biaxial TAC film used as a substrate film for OCB-WV.

TAC films are suitable for the water-based polarizer manufacturing process due to high moisture permeability. The biaxial TAC film is used as a protective film for polarizer as well as a part of an optical compensation film.

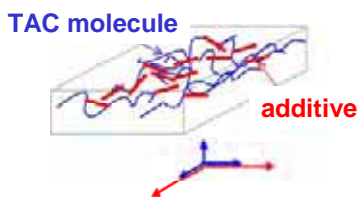

Figure 5. Additive molecules inside the TAC film to control Rth.

6. PDM Layer

The PDM layer has a hybrid alignment structure with the tilt angle continuously changing in the thickness direction. This alignment structure is fine-tuned to match very well with the half of the bend alignment structure of the pi-cell.

Polarized micro-Raman spectroscopy revealed that the change in tilt was non-linear and that the order parameter also changed with a high degree of randomness in the vicinity of the alignment layer surface¹⁷.

7. Response Time

Most of nematic LCD modes have relatively slow electro-optical response partially due to the back flow effect. When the applied voltage is changed, flow inside the LC cell gives rise to backward director torque that slows the relaxation process. On the other hand, flow inside the pi-cell does not obstruct the director torque, facilitating the director change. This is the origin of the fast electro-optical response of the pi-cell.

Even at low temperatures, OCB has fast response time and is capable of displaying moving pictures while other LCD modes do not. This feature makes OCB available for a variety of applications, including automobile applications that could experience very low temperature.

8. Moving Picture Quality

Recently, MPRT (moving picture response time) becomes popular as an index for moving picture quality. MPRT is the average of BET (blurred edge time) values between different gray levels. As mentioned before, there are proposals of reducing motion blur and improving moving picture quality, including high frame rate driving, backlight blinking, black level insertion and gray level insertion.

To evaluate the effect of LC panel response, frame rate and backlight blinking, MPRT calculation was made¹⁸. As a result, OCB coupled with a high frame rate showed the best MPRT performance. While LCD modes popularly used for LCD-TVs have MPRT values larger than 10ms, OCB coupled with a double frame rate shows an MPRT value very close to that of CRT, as shown in Fig. 7. Actual panels developed support the numerical simulation data.

This means that as the frame rate becomes high to improve moving picture quality, the LC panel response becomes more significant and should be fast to complete the rise and decay processes within a very short frame time.

It should be noted that new ideas, such as gray level insertion¹⁹, improves MPRT as well as light transmittance, which was a problem for black level insertion.

9. Field Sequential Color

On the contrary to the color filter system, the field sequential color (FSC) method (Fig. 6) divides the time frame into three primary color fields to produce full color without color filters. FSC has the advantages of high resolution, high transmittance and vivid moving picture quality. Since one frame time is divided into three, FSC requires fast LC panel response such as OCB. A test FSC-OCB panel with LED backlight fabricated by Uchida's group showed a great promise as a future LCD²⁰. LED backlight system is capable of widening the color gamut.

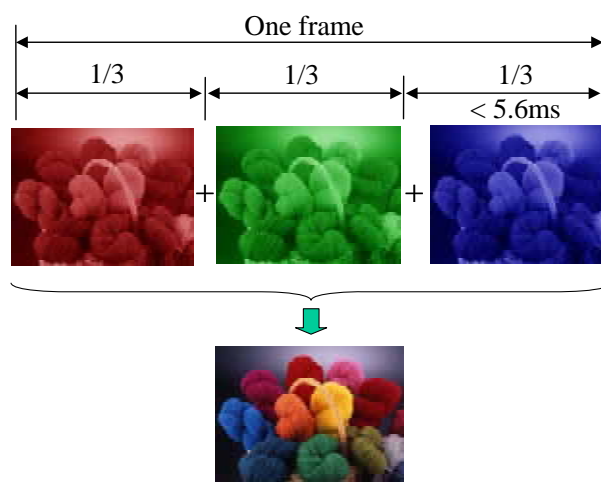

Figure 6. Field sequential Color (FSC) method.

The spectrum sequential method proposed by Langendijk *et. al.* has primary colors more than three and enlarges color gamut by combining color filters with two types of

fluorescent lamps with different spectra²¹). Since two images are changed in one frame time, this method also requires fast LC panel response. OCB is a strong candidate for the panel using the spectrum sequential method.

10. Conclusions

The technologies developed for the WV film for TN were further explored to realize the OCB-WV film. The OCB-WV film makes use of the hybrid alignment structure of the PDM layer coated on a newly developed biaxial TAC film and aligned in the 45-degree direction. The biaxial TAC film has large Re and Rth values, compared with the substrate film for the TN-WV film. OCB-WV optically compensates the birefringence of the pi-cell and suppresses light leakage from crossed polarizers at oblique incidence.

The development of OCB-WV has made a next generation LCD-TV possible with an excellent moving picture quality as well as very wide viewing angle characteristics. The OCB-LCD opens up possibilities of very wide color gamut in combination with advanced backlight technologies and even has the potential of color filter-less LCDs.

References

1. K. Ohmuro, S. Kataoka, T. Sasaki and Y. Koike: SID'97 Dig., p. 845 (1997).
2. D. Kajita, I. Hiyama, Y. Ustumi, K. Miyazaki, M. Hasagawa and M. Ishii: SID'06 Dig., p. 1162 (2006).
3. S. S. Kim, B. Berkeley, K. H. Kim, J. K. Song, Journal of the SID, Vol. 12, Number 4 (2004).
4. H. Mori: Journal of Display Technology, Vol. 1, No. 2, p. 179-186 (2005).
5. Y. Saitoh, S. Kimura, K. Kusafuka and H. Shimizu: SID '98 Dig., p. 706 (1998).

6. J. Chen, K.-H. Kim, J.-J. Lyu, J. H. Souk, J. R. Kelly and P. J. Bos: SID '98 Dig., p. 315 (1998).
7. J. Hirakata, A. Shingai, Y. Tanaka and K. Ono: SID'01 Dig., p. 990 (2001).
8. K. Miwa and H. Nakamura: IDW'97 Dig., p. 85 (1997).
9. T. Kurita: SID'01 Dig., p. 986 (2001).
10. Y. Shimodaira: SID'03 Dig., p. 1034 (2003).
11. P. J. Bos and K. R. Koehler/Beran: Mol. Cryst. Liq. Cryst., 113, 329 (1984).
12. K. Nakao, D. Suzuki, T. Kojima, M. Tsukane and H. Wakemoto: SID '04 Dig., p. 1416 (2004).
13. Y. Yamaguchi, T. Miyashita and T. Uchida: SID'93 Dig., p. 277 (1993).
14. P. J. Bos and J.A. Rahman: SID'93 Dig., p. 273 (1993).
15. Y. Ito, R. Matsubara, R. Nakamura, M. Nagai, S. Nakamura, H. Mori and K. Mihayashi: SID '05 Dig., p. 986 (2005).
16. H. Mori, M. Nagai, H. Nakayama, Y. Itoh, K. Kamada, K. Arakawa and K. Kawata: SID'03 Dig., p. 1058 (2003).
17. Y. Takahashi, H. Watanabe and T. Kato: IDW'04 Dig., p. 651 (2004).
18. N. Yamagishi, H. Ishibashi, Y. Tanabe and H. Yamagami: SID'06 Dig., p. 1804 (2006).
19. J.-W. Lee *et. al.*: SID '06 Dig., p. 1950 (2006).
20. T. Uhida *et. al.*: SID'06 Dig., p. 166 (2006).
21. E.H.A. Langendijk: IDW/AD'05 p.235 (2005).

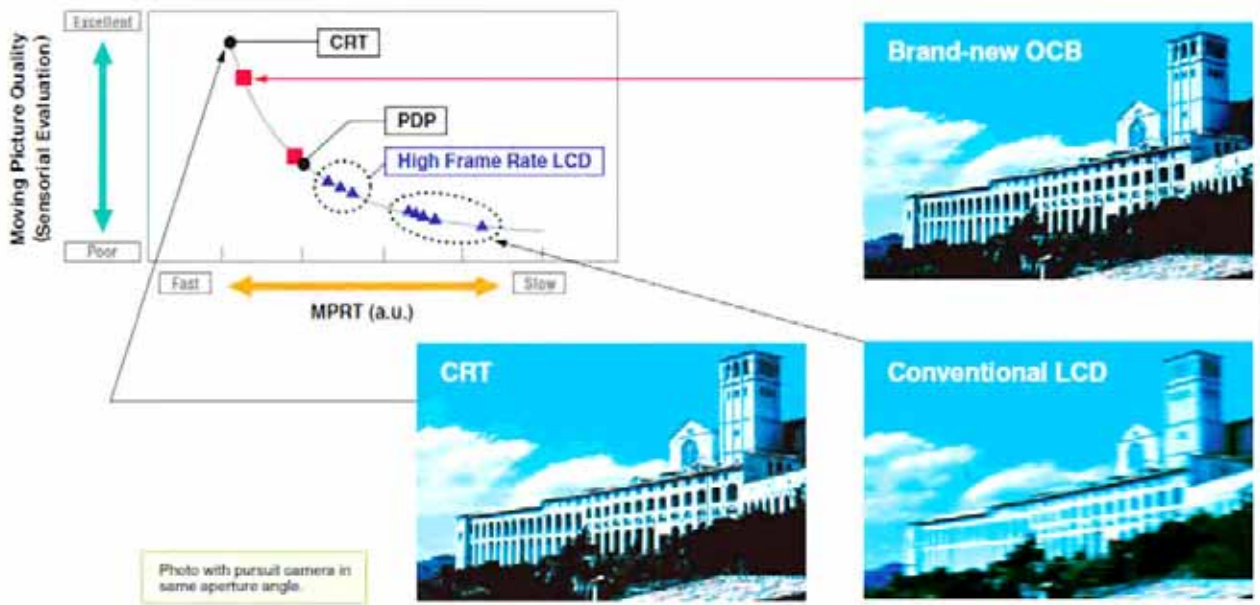

Figure 7. Moving picture quality of OCB.