

Enhancement of Off-Axis Viewing Quality with Temporal Dual Gamma Drive in Patterned Vertical Alignment Mode

Young-Chol Yang*, Baek-Woon Lee, Dae-Jin Park
 LCD R&D Center, LCD Business, Samsung Electronics,
 San 24, Nongseo-Dong, Giheung-Gu, Yongin-City, Gyeonggi-Do, 449-711, Korea
 Phone: 82-31-209-7761 , E-mail: ycyang@samsung.com

Abstract

Temporal dual gamma drive technology employing the 120Hz refresh rate was developed to enhance the off-axis viewing quality in patterned vertical alignment mode. The color shift $\Delta u'v'$ from on-axis to off-axis (60 deg.) for pale orange color, $(R,G,B) = (196,124,96)$, was below 0.01, and the power exponent of gamma curve for off-axis viewing angle (60 deg.) was about 1.8, when the gamma curve for on-axis was set with power exponent of 2.4. The off-axis image distortion index was below 0.180 in contrast to the normal case ~ 0.23 . To elevate the response speed of liquid crystal in the intra-frame, the voltage below threshold voltage of liquid crystals was used.

1. Introduction

It is believed that there is no problem in the off-axis viewing angle characteristics based on the contrast ratio 10:1. Many major LCD companies have reported that the contrast ratio of their product is beyond 10:1 for all range of viewing angle. Recently, however, the color shift and the gamma curve distortion for the change of viewing angles have been issued up especially for TV or monitor applications. Several dual gamma drive technologies have been proposed to solve these problems [1, 2]. In this paper, we propose a temporal dual gamma (TDG) drive technology.

2. Temporal Dual Gamma Drive Scheme with the Frame Rate of 120Hz

In the dual drive gamma drive scheme, a pair of data corresponding to the given data for a certain image to be displayed on the panel is sent to the each pixel. The spatial scheme and the temporal scheme have been proposed [1, 2]. In the temporal scheme, a pair of data is applied to a pixel consecutively during one frame-time using the doubled frame rate drive method. In the spatial scheme, two data are applied to the pixel spatially divided by two parts during one frame-time.

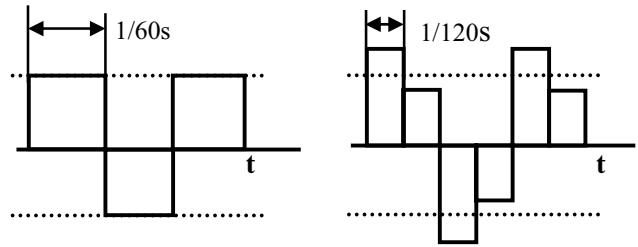

(a) conventional drive (b) temporal dual γ drive

Figure 1. Drive schemes

As shown in figure 1 (a), data signal in normal LCD are transmitted to the pixels with 60Hz (or 50Hz) refresh rate. The waveform of data signals in temporal dual gamma drive scheme is shown in figure 1 (b). A given frame is divided into two sub-frames and two data is sent to a pixel consecutively with 120Hz (or 100Hz) refresh rate, one of which is higher than original one and another is lower. It is noticed here that the consecutive signals have same polarity of voltage to keep the DC-free requirement in the LCD pixels. Of course, the time-averaged brightness for two consecutive signals should be same with the brightness corresponding to the original signal.

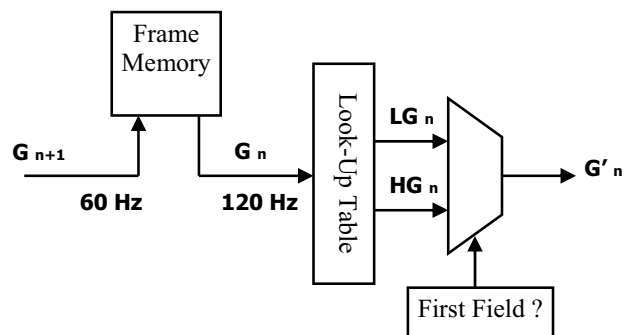

Figure 2. Schematic drawing of temporal dual gamma drive

Figure 2 depicts the basic operation of temporal dual gamma drive scheme. The frame rate of input signal is assumed to be conventional 60Hz. During (n+1)-th frame, (n+1)-th frame data are stored in frame memory. Two sub-frame data, lower gray signal LG_n and higher gray signal HG_n , are produced by the the look-up table referencing the n-th frame data G_n stored in the frame memory previously. Then, the final signal G'_n , selected by appropriate order between LG_n and HG_n , is to be transferred to each pixel.

Figure 3 shows the waveform of dual gamma drive scheme and corresponding response of brightness. Because the speed of liquid crystal motion when the applied voltage is changed is finite, the time evolution of brightness does not follow the applied voltage exactly as shown in figure 3. In dual gamma scheme, it is required that the difference of brightness between first and second sub-frame should be as large as possible to achieve the sufficient suppression of color shift and gamma curve distortion for off-axis viewing angle. However, in the conventional liquid crystal displays, the voltage range to be applied to the pixels is limited by the maximum driving voltage of drive IC and threshold voltage of liquid crystal, V_{th} . In this study, for maximizing the difference of brightness between first and second sub-frame, the voltage lower than V_{th} was used. As well known, if the applied voltage is lower than V_{th} , the liquid crystal does not respond. However, even if the voltage lower than V_{th} is applied during a current frame, the liquid crystal in motion or under the voltage higher than V_{th} during the previous frame does respond to the voltage. In fact, as the applied voltage is lower, the response of liquid crystal is faster. This is because the voltage for black gray (0G) in conventional LCD employing overdrive scheme is much lower than V_{th} to get faster falling speed as the curve with open square in figure 4 shows. Of course, the voltage for the secondly dark gray level (1G) is slightly higher than V_{th} .

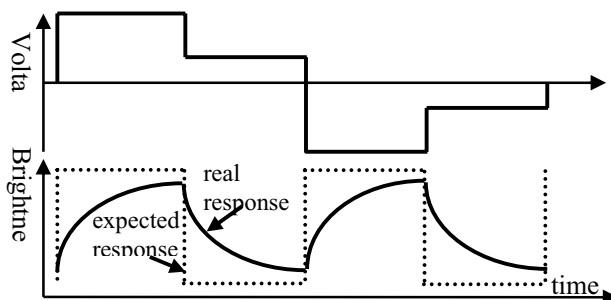

Figure 3. The waveform of temporal dual gamma drive and the time evolution of brightness

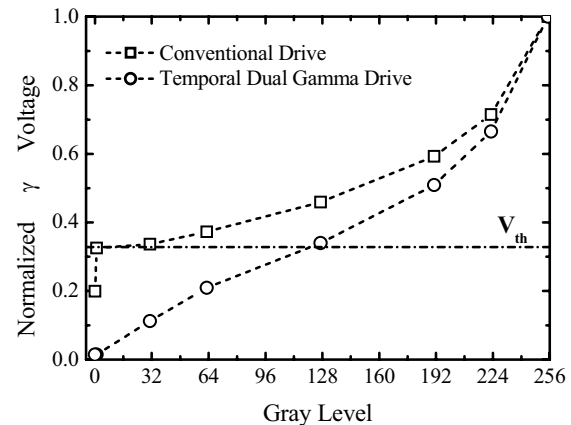

Figure 4. Gamma Voltages.

To apply this principle to the temporal dual gamma driving scheme, the gamma voltages lower than V_{th} were used for the gray levels from black to middle gray (~128 gray) as the curve with open circle in figure 4 shows. Figure 5 shows the look-up table (LUT) of temporal dual gamma drive. Higher Gray (open circle) is associated with HG_n and Lower Gray (open square) with LG_n . For example, $LG_n = 54$ and $HG_n = 255$ are consecutively applied to a pixel for displaying 192nd gray level. This indicates that the voltage lower than V_{th} is used for the gray level of 192G. It is noted here that $LG_n = 255$ and $HG_n = 255$ was used for full white gray (255G) to preserve the maximum brightness the panel provides. Black gray (0G) were also realized with $LG_n = 0$ and $HG_n = 80$, and the corresponding voltages of them are both lower than V_{th} to minimize the black luminance.

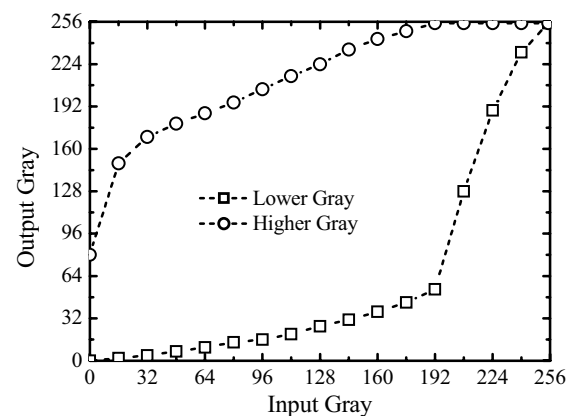

Figure 5. Look-up table for dual gamma drive.

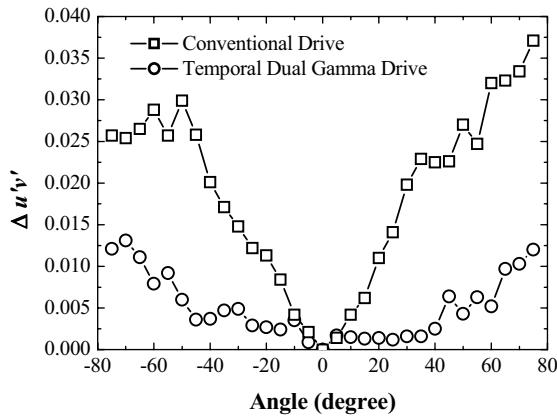

Figure 6. Color shift as a function of horizontal viewing angle.

3. Results

The color shift and gamma curve distortion for the change of viewing angle were measured with 40-inch PVA (patterned vertical alignment mode) panel. Figure 6 shows the color shift as a function of viewing angle (along horizontal direction) for the pale orange color, (R,G,B) = (196, 124, 96). The amount of shift is defined as the length between the coordinate points for on-axis and off-axis viewing angle in $u'v'$ color space, $\Delta u'v'$, and is given by

$$\Delta u'v' = \sqrt{(u'_A - u'_O)^2 + (v'_A - v'_O)^2}, \quad (1)$$

where the subscript 'A' represents the off-axis viewing angle and 'O' stands for the on-axis. In both cases, the color shift increases as the viewing angle increases. But in the conventional drive scheme (open square), the color shift touches the value beyond 0.025, while, in the temporal dual gamma drive scheme (open circle), the shift is suppressed under the 0.010 for the viewing angle within 60 degree.

Figure 7 shows the gamma curves for on-axis (0 deg.) and off-axis (60 deg.). The fitted gamma values (exponent of power function) for the off-axis viewing angle in the conventional drive and the temporal dual gamma drive schemes were 1.6 and 1.8, respectively, when the gamma value for on-axis was set to 2.4. Off-axis *Gamma Distortion Index* is also widely used as a metric for deterioration of image quality at the off-axis viewing angles, which is given by [3]

$$D = \frac{1}{N^2} \sum_{i \neq j} \text{Max} \left(1 - \frac{y_i^{(60)} - y_j^{(60)}}{y_i^{(0)} - y_j^{(0)}}, 0 \right), \quad (2)$$

where

$$y_j^{(A)} = 116 \left(\frac{Y_j^{(A)}}{Y_N^{(A)}} \right)^{1/3} - 16. \quad (3)$$

N is the number of gray levels and $Y_j^{(A)}$ is the luminance of j -th gray level for viewing angle of 'A'. The index ranges from zero to unity, and gives smaller value for the case of the less gamma distortion. The calculated values of gamma distortion index were 0.18 for temporal dual gamma drive scheme and 0.23 for conventional drive scheme.

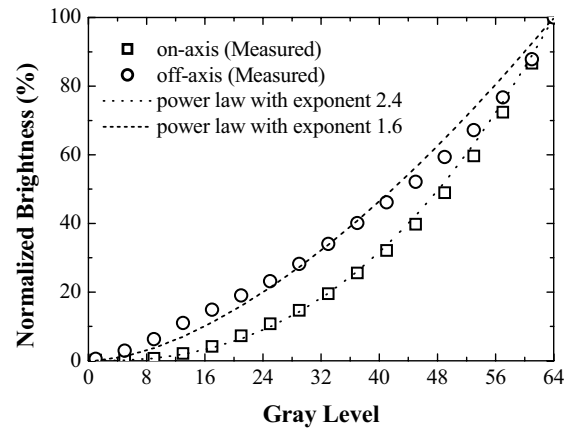

(a) conventional drive.

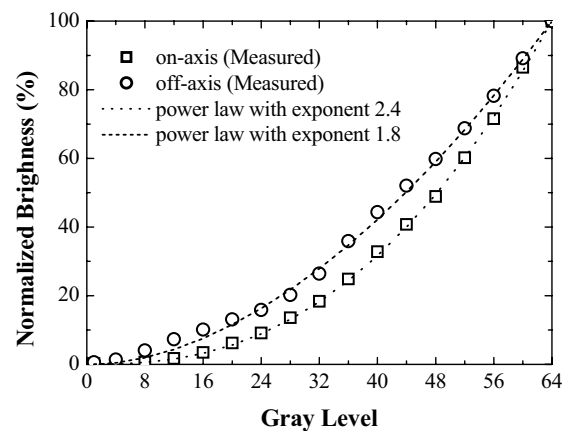

(b) temporal dual gamma drive.

Figure 7. Gamma curves for on-axis (0 deg.) and off-axis (60 deg.) viewing angles.

4. Conclusion

Temporal dual gamma drive technology was developed to enhance the off-axis viewing quality in PVA (patterned vertical alignment) mode. In this scheme, a pair of data is produced referencing the look-up table to be transferred to a pixel consecutively during the given frame with the doubled frame rate drive (120Hz) method. To compensate the slow response of liquid crystal during intra-frames, the voltage below threshold voltage of liquid crystal was used by modifying the gamma-resister-string which defines the gamma voltages. Measurements with 40-inch real panel showed that image quality deterioration at the off-axis viewing angle coming from color shift or gamma curve distortion could be reduced by the temporal dual gamma drive scheme. The color shift $\Delta u'v'$ from on-axis to off-axis (60 deg.) for pale orange color, (R,G,B) = (196,124,96),

was below 0.01 (~0.25 for conventional drive), and the power exponent of gamma curve for off-axis viewing angle of 60 deg. was about 1.8 (~1.6 for conventional drive), when the gamma curve for on-axis was set with power exponent of 2.4. The off-axis image distortion index was below 0.180 in contrast to the normal case ~0.23.

5. References

- [1] S. S. Kim, SID '05 Tech. Dig. Papers **36**, 1842 (2005).
- [2] N. Kimura, T. Ishihara, H. Miyata, T. Kumakura, K. Tomizawa, A. Inoue, S. Horino, Y. Inaba, SID '05 Tech. Dig. Papers **36**, 1734 (2005).
- [3] S. S. Kim, SID '04 Tech. Dig. Papers **35**, 760 (2005).