

Steering Wheel Torque Control of Electric Power Steering by PD-Control

Du-Yeol Pang*, Bong-Choon Jang** and Seong-Cheol Lee***

* Graduate of Mechanical Engineering, Chonbuk National University, JeonJu, Korea
(Tel : +82-10-4651-6809; E-mail: fishhh@hotmail.com)

**Department of Mechanical Engineering, Andong National University, Andong, Korea
(Tel : +82-54-820-6158; E-mail: bjang@andong.ac.kr)

*** Department of Mechanical Engineering, RCIT, Chonbuk National University, JeonJu, Korea
(Tel : +82-63-270-2320; E-mail: meconlee@chonbuk.ac.kr)

Abstract: As the development of microprocessor technology, electric power steering (EPS) system which uses an electric motor came to use a few years ago. It can solve the problems associated with hydraulic power steering. The motor only operates when steering assistance is needed, so it can save fuel and can reduce weight and cost by eliminating hydraulic pump and piping. As one of performance criteria of EPS systems, the transmissibility from road wheel load to steering wheel torque is considered in the paper. The transmissibility can be studied by fixing the steering wheel and calculating the torque needed to hold the steering wheel from road wheel load. A proportion-plus-derivative control is needed for EPS systems to generate desired static torque boost and avoid transmissibility of fluctuation. A pure proportion control can't satisfy both requirements.

Keywords: electric power steering(EPS), column-type electric power steering(CEPS), electric control unit(ECU), torque boost, transmissibility, fluctuation, proportion-plus-derivative control(PD-control)

1. INTRODUCTION

Automobile market has faced with innovation of power steering. Manual steering system was used in the beginning, but it makes driver laborious and needs much effort. Hydraulic power steering system had been used in past 50 years since Delphi developed hydraulic powering steering in the middle of 1950s[9]. Hydraulic power steering system uses oil pressure as a power source, so it must always retain oil pressure from engine power, so it becomes fuel consuming and needed lots of components like hydraulic pump, hoses, hydraulic fluids, and drive belt and pulley on engine.

As the development of microprocessor, power electronics and high power motor technologies, electric power steering (hereafter called EPS) system which uses an electric motor came to use a few years ago[6,7]. It can solve the problems associated with hydraulic power steering. The motor only operates when steering assistance is needed i.e. power on demand, so it is energy efficient and environmentally compatible while offering extras like simplified tuning, packaging, flexibility, and engine-off steering assist[9].



Fig. 1 CEPS and the following EPS configurations.

EPS systems are called EPS(electric power steering system), EPAS(electric power assisted steering system) and MDPS(motor driven power steering system) according to manufacturers but the basic organizations and principles are similar. EPS systems can be categorized as Fig. 1 according to the location of power assist, i.e. column-type EPS, pinion-type EPS, rack-type EPS and electrically powered hydraulic steering system (EPHS). Column-type electric power steering (hereafter called CEPS) system is generally applied to

midget-class cars which have a small-capacity engine (660cc), where fuel efficiency is important and it can save space in engine room layout because motor and reduction gear are incorporated and installed in interior[4,5].

EPS system has electric control unit (ECU) to calculate optimum assist torque based upon torque sensor and vehicle speed sensor, to output the calculation results to power unit. And power unit drive a motor according to signal issued by the control unit[6,7].

Tokumoto[11] in Koyo has proposed next-generation torque sensor for EPS that can detect steering torque and steering angle and the developed sensor can used not only for EPS power assistance control but also for safety cruise control and intelligent driving of the vehicle. Chen[12] in Hermes Technologies shows the effectiveness of derivative term of torque sensor with simplified EPS model. Kohno[13] in Toyota has been confirmed that H_{∞} control is valid as a basic logic for EPS system and then shows robustness is validated by manufactured prototype. Pryjmak[14] proposed following method to reduce motor armature inertia effects with P-gain. Implement the lowest possible armature and use brushless DC motor with permanent magnet field in rotor and armature winding in the stator, and use new rare earth material in the rotor to achieve greater torque capability and connect the motor gear box to the steering rack through a bidirectional one way input lock up clutch. Oshita[8] in Fuji shows that can enhance the stability by proportional gain. Shimizu[7] in Honda adopts ball-screw type EPS for sports car NSX and shows steering torque characteristics can be enhanced by using steering torque and steering angular velocity gain.

In this paper, CEPS system is modeled in consideration of non-linear parameter such as Coulomb friction. As one of the design criteria of EPS system, it can be considered that driver's steering wheel torque which is transmitted from road wheel load. The transmissibility from road wheel load to steering wheel can be studied by fixing the steering wheel and calculating the torque needed to hold steering wheel. So with the proper control algorithm of ECU, assisted power must alleviate external load, so driver could be felt pleasant without losing road information.

A proportional-plus-derivative control can generate desired static torque boost and avoid fluctuation. A pure proportional control can't satisfy both requirements. So it needs both derivative and proportional term of torque sensor in the EPS control to generate proper torque boost and to eliminate fluctuation.

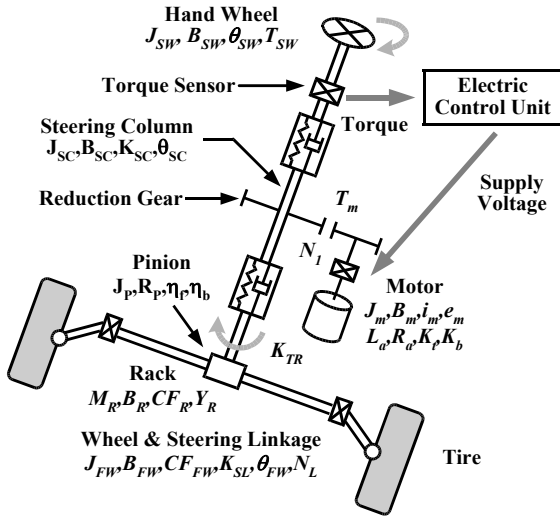

Fig.2 Column-type EPS System.

2. MODELLING

Typical CEPS system is shown in Fig. 2 and the major components are a torque sensor, a motor, a reduction gear and a ECU. Torque sensor is located between steering wheel and steering column and measures the applied torque by

converting difference of twisted angle to electric signal. The motor is attached in steering column through reduction gear box. ECU calculates motor target current from the signal of torque sensor and vehicle velocity. So the calculated torque is applied to steering column by motor through reduction gear. The transmissibility of CEPS system from road wheel load to driver's hand wheel can be investigated by calculating driver's hand wheel torque while fixing hand wheel. The equation of hand wheel is like Eq. (1), and displacement, velocity and acceleration of hand wheel is zero by assuming fixed hand wheel that is $\theta_{SW} = \dot{\theta}_{SW} = \ddot{\theta}_{SW} = 0$.

$$J_{SW} \ddot{\theta}_{SW} + B_{SW} \dot{\theta}_{SW} + K_{SC} (\theta_{SW} - \theta_{SC}) = T_{SW}, \quad (1)$$

And, equilibrium equation of steering column is Eq. (2),

$$J_{eq} \ddot{\theta}_{SC} + B_1 \dot{\theta}_{SC} + K_{SC} (\theta_{SC} - \theta_{SW}) = T_m - T_p, \quad (2)$$

where, J_{eq} is equivalent polar moment of inertia and B_1 is equivalent viscous damping of motor, reduction gear and steering column with respect to steering column.

By assuming dc servomotor is used, motor torque with respect to steering column while neglecting inductance of motor, is Eq. (3)

$$T_m = \frac{N_1 K_t}{R_a} (e_m - K_b N_1 \dot{\theta}_{SC}), \quad (3)$$

The motor voltage in PD-control is Eq. (4)

$$e_m = -K_p (\theta_{SC} - \theta_{SW}) - K_d (\dot{\theta}_{SC} - \dot{\theta}_{SW}), \quad (4)$$

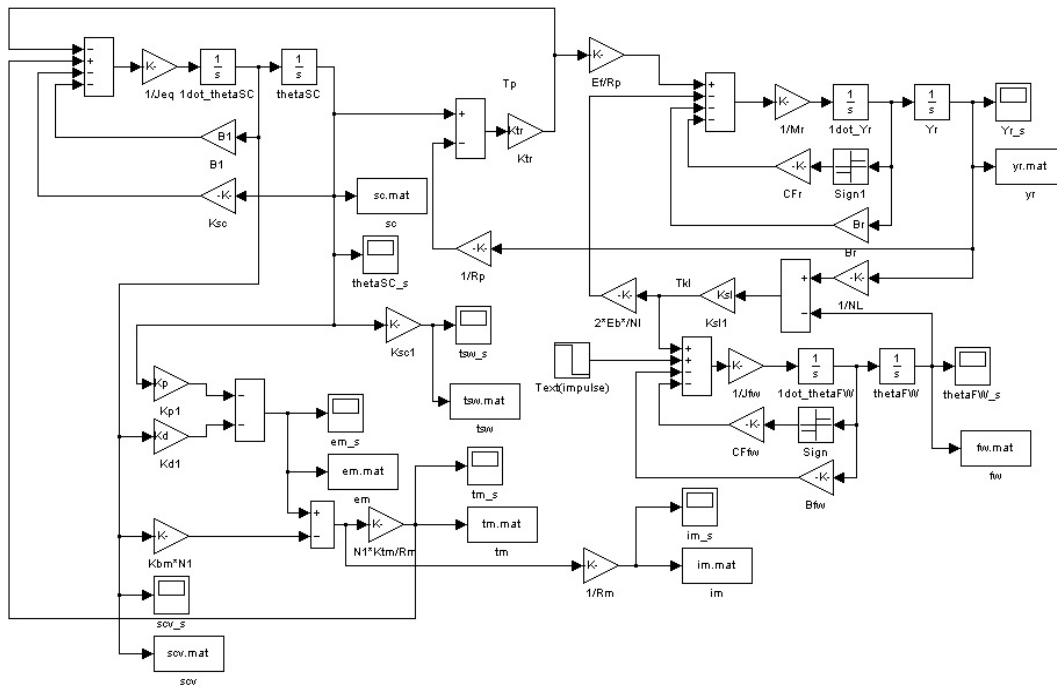

Fig. 3 Block diagram of Matlab Simulink for simulation.

The torque at pinion in Eq. (2) can be assumed as Eq. (5).

$$T_p = K_{TR} \left(\theta_{SC} - \frac{Y_R}{R_p} \right), \quad (5)$$

By substituting Eqs. (3)-(5) into Eq.(2), Eq.(6) can be obtained as follows.

$$J_{eq} \ddot{\theta}_{SC} + B_{eq} \dot{\theta}_{SC} + K_{eq} \theta_{SC} = K_{TR} \frac{Y_R}{R_p}, \quad (6)$$

where,

$$J_{eq} = J_{SC} + N_1^2 J_m,$$

$$B_{eq} = B_{SC} + N_1 B_m + \frac{N_1^2 K_t K_b}{R_a} + \frac{N_1 K_t}{R_a} K_d,$$

$$K_{eq} = K_{SC} + K_{TR} + \frac{N_1 K_t}{R_a} K_p,$$

And, equilibrium equation of steering rack bar is Eq.(7),

$$M_R \ddot{Y}_R + B_R \dot{Y}_R + CF_R \times \text{sgn}(\dot{Y}_R) = \eta_F \frac{T_p}{R_p} - 2\eta_B \frac{T_{KL}}{N_L}, \quad (7)$$

And, equilibrium equation of road wheel is Eq.(8),

$$J_{FW} \ddot{\theta}_{FW} + B_{FW} \dot{\theta}_{FW} + CF_{FW} \times \text{sgn}(\dot{\theta}_{FW}) = T_{KL} + T_{ext}, \quad (8)$$

Here, torque at steering linkage is Eq.(9)

$$T_{KL} = K_{SL} \left(\frac{Y_R}{N_L} - \theta_{FW} \right). \quad (9)$$

By using Eqs. (1)-(9), driver's hand wheel torque T_{SW} in Eq. (1) is calculated from the input of road wheel load T_{ext} in Eq. (8). T_{ext} is a unit impulse torque at road wheel. MatLab Ver.6.5.1 Simulink was used for simulation and block diagram of Simulink is shown in Fig. 3 and physical parameters are shown in Table. 1.

3. SIMULATION AND RESULTS

Fig. 4 shows frequency response by using Bode diagram in cases of without control (dotted line), proportion control (dash dotted line) and proportion-plus-derivative control (solid line). Proportion gain, $K_p=20000$ was chosen to make the transmissibility at low frequency range equal to one fifth of without control. In proportion control, the gain of Bode diagram shows larger value around $\omega=1200\text{rad/sec}$ (191Hz), which is undesirable and it makes high frequency torque disturbance to pass through. The time responses of steering wheel torque to a unit torque impulse at road wheel are shown in Fig. 5. For the system with proportion control, drivers will be felt the high frequency oscillation when road wheel endures an impact.

The problems in proportion control can be eliminated by using proportion-plus-derivative control. We made a choice appropriate proportion gain ($K_p=20000$) to achieve desired steering assistance level and derivative gain ($K_d=300$) to reach

required damping ratio. The transmissibility of a system with proportion-plus-derivative control (solid line) is shown in Fig. 4 and it realizes proper torque boost in low frequency range, and decrease gain in high frequency range. Impulse response of proportion-plus-derivative control in time domain is shown in Fig. 5 (solid line) and comparing with without control (dotted line) and proportion control (dash dotted line), the response is much improved, peak amplitude is lower and high frequency oscillation no longer exists.

Table 1. Physical parameters of CEPS system.

Parameters	Values	Units
J_{SW}	0.03444	kg-m ²
J_{SC}	0.03444	kg-m ²
J_{FW}	0.61463	kg-m ²
J_m	3.5×10^{-4}	kg-m ²
M_R	2.0	kg
B_{SW}	0.36042	N-m/(rad/sec)
B_{FW}	88.128	N-m/(rad/sec)
B_{SC}	0.36042	N-m/(rad/sec)
B_R	88.128	N-m/(m/sec)
B_m	0.05	N-m/(rad/sec)
CF_R	0.04	N
CF_{FW}	0.04	N
K_{SW}	42057	N-m/rad
K_{SC}	42057	N-m/rad
K_{TR}	42057	N-m/rad
K_{SL}	14878	N-m/rad
L_a	0.0001	H
R_a	0.1	Ω
K_t	0.0533	N-m/A
K_b	0.0533	V/(rad/sec)
N_1	49/3	
R_p	0.007367	m
N_L	0.11816	m
η_F	0.985	
η_B	0.985	

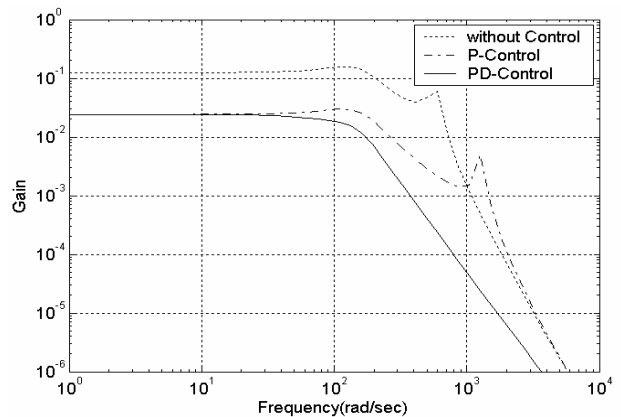

Fig. 4 Transmissibility of column-type EPS System.

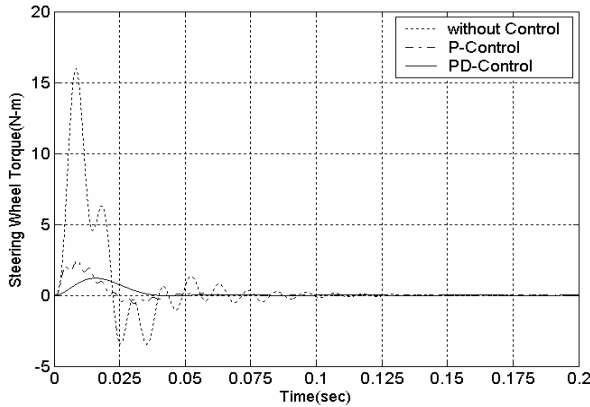

Fig. 5 Impulse response of steering wheel torque.

Fig. 6 shows assisted motor torque with respect to steering column at each control scheme. In the case of without control, motor back-electromotive force act like a viscous damping, so there appears small amount of damping effects in motor torque. In proportion control and proportion-plus-derivative control, motor assist torque to steering column through gear-box. In proportion-plus-derivative control motor torque shows smooth curve while proportion control shows fluctuation.

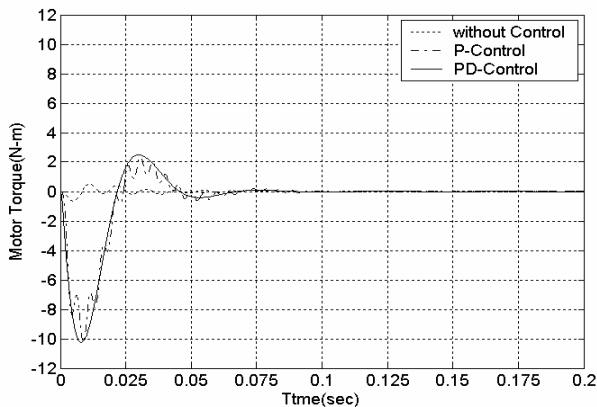

Fig. 6 Assisted motor torque at steering column.

Fig. 7 shows steering column displacement in degree and Fig. 8 shows steering rack bar displacement in mm at each control scheme. The amount of displacement in Fig. 7 and Fig. 8 shows relatively small. And there is no fluctuation only in proportion-plus-derivative control.

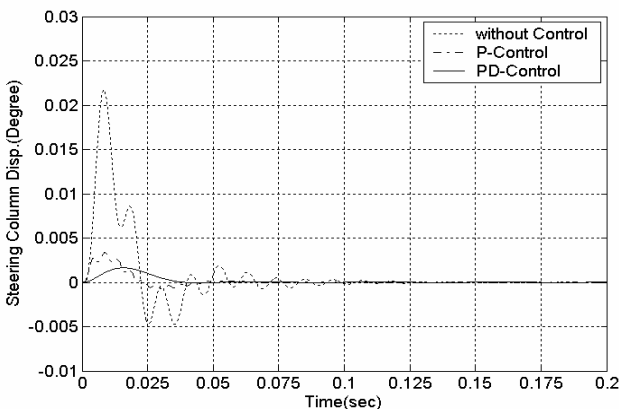

Fig. 7 Displacement of steering column.

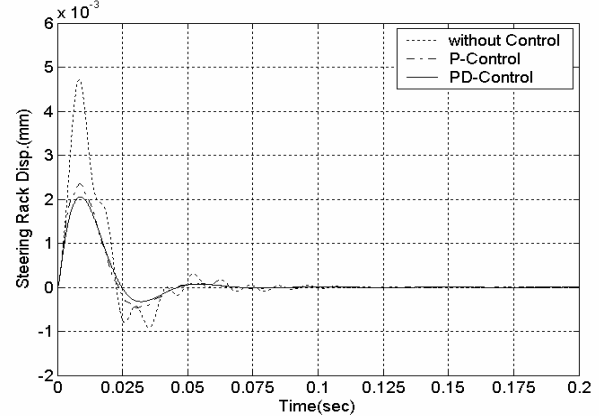

Fig. 8 Displacement of steering rack.

4. CONCLUSION

With pure proportion control in column-type EPS system can generate proper torque boost but can't avoid high frequency fluctuation because of insufficiency of damping.

So to give proper damping, a proportion-plus-derivative control is needed for a column-type EPS and it can generate desired static torque boost and avoid the high frequency fluctuation.

ACKNOWLEDGEMENTS

This research was supported by the Research Center of Industrial Technology(RCIT), Engineering Research Institute at Chonbuk National University.

NOMENCLATURE

- B_1 : Equivalent viscous damping respect to steering column including damping of motor and steering column (N-m/(rad/sec)).
- B_{eq} : Equivalent viscous damping respect to steering column (N-m/(rad/sec)).
- B_{FW} : Viscous damping at steering linkage bushing (N-m/(rad/sec)).
- B_m : Viscous damping of motor(N-m/(rad/sec)).
- B_R : Viscous damping of steering rack(N-m/(rad/sec)).
- B_{SC} : Viscous damping of steering column(N-m/(rad/sec)).
- B_{SW} : Viscous damping of steering wheel(N-m/(rad/sec)).
- CF_{FW} : Coulomb friction breakout force on road wheel(N).
- CF_R : Coulomb friction breakout force on steering rack(N).
- e_m : Motor input voltage(V).
- J_{eq} : Equivalent moment of inertia respect with steering column(kg-m²).
- J_{FW} : Moment of inertia of road wheel and rotation mass about steering displacement(kg-m²).
- J_{SC} : Moment of inertia of steering column(kg-m²).
- J_{SW} : Moment of inertia of steering wheel(kg-m²).
- M_R : Mass of steering rack(kg).
- K_b : Motor back electromagnetic force constant (V/(rad/sec)).
- K_{eq} : Equivalent rotational stiffness respect to steering column(N-m/rad).
- K_d : Derivative gain.

K_p : Proportional gain.
 K_{SC} : Steering column rotational stiffness(N-m/rad).
 K_{SL} : Steering rotational stiffness due to linkage and bushing (N-m/rad).
 K_{SW} : Steering wheel rotational stiffness(N-m/rad).
 K_t : Motor torque constant(N-m/A).
 K_{TR} : Torsion bar rotational stiffness(N-m/rad).
 L_a : Motor armature winding inductance(H).
 N_i : Motor gear box gear ratio.
 N_L : Steering linkage rate(m).
 R_a : Motor armature winding resistance(Ω).
 R_p : Radius of pinion(m).
 T_{ext} : External torque at road wheel(N-m).
 T_{KL} : Torque at steering linkage(N-m).
 T_m : Motor torque with respect to steering column(N-m).
 T_p : Torque at pinion(N-m).
 T_{SW} : Torque at steering wheel(N-m).
 Y_R : Translational displacement of the rack(m).
 η_B : Gear ratio efficiency of backward torque transmission.
 η_F : Gear ratio efficiency of forward torque transmission.
 θ_{FW} : Angular displacement of road wheel(rad).
 θ_p : Angular displacement of pinion(rad).
 θ_{SC} : Angular displacement of steering column(rad).
 θ_{SW} : Angular displacement of steering wheel(rad).

- [13] T. Kohno, S. Takeuchi, M. Momiyama, H. Nimura, E. Ono, and S. Asai, "Development of Electric Power Steering System with H_∞ Control," *SAE 2000-01-0813*, 2000.
- [14] B. I. Pryjmak, "Simulation of Electric Power Steering Armature Inertia Effects on Vehicle System Handling Response Using bondgraph Technology," *SAE 851639*, 1983.
- [15] H. H. Lee and C. C. Lee, "Vision-Based Line Tracking and Steering Control of AGVs," *ICCAS 2002 International Conference on Control, Automation and Systems*, pp.3009, 2002.
- [16] J. H. Kim, S. H. Son, Y. C. Lim, T. G. Kim, Y. J. Ryoo and E. S. Kim, "Development of Fuzzy Steering Controller for Outdoor Autonomous Mobile with MR Sensor," *ICCAS 2002. International Conference on Control, Automation and Systems*, pp.83, 2002.

REFERENCES

- [1] B. C. Jang and S. C. Lee, "A Mathematical Model of a Power Steering System," *KSAE*, Vol.5, No.4, pp.39-47, 1997.
- [2] T. O. Tak, K. C. Kim, and J. R. Yun, "Steering Model for Vehicle Dynamics Analysis," *KSPE*, Vol.16, No.12, pp.214-221, 1999.(in Korean)
- [3] S. C. Yun, Y. Y. Wang, and C. S. Han, "A Study on the Control Algorithm for a Ball Screw Type of Motor Driven Power Steering System," *KSAE*, No.2000-03-0015, vol.8, No.1, pp.124-134, 2000.(in Korean)
- [4] T. Nakayama and E. Suda, "Present and Future of Electric Power Steering," *Automotive Technology*, Vol.44, No.1, pp.106-111, 1990.(in Japanese)
- [5] T. Nakayama and E. Suda, "The Present and Future of Electric Power Steering," *Int. J. of Vehicle Design*, Vol.15, Nos 3/4/5, pp.243-254, 1994.
- [6] Y. Shimizu, M. Sugino, T. Kawai, and T. Matsumoto, "Electric Power Steering," *Automotive Technology*, Vol.45, No.10, pp.53~60, 1991.(in Japanese)
- [7] Y. Shimizu and T. Kawai, "Development of Electric Power Steering," *SAE Paper 910014*, pp.105-119, 1991.
- [8] S. Oshita, T. Mouri, T. Takahashi, and S. Ito, "All Electric Power Steering System," *Automotive Technology*, Vol.41, No.10, pp.1206-1212, 1987.(in Japanese)
- [9] A. Badway, F. Bolourchi, and K. Gaut, "E•Steer™ System Redefines Steering Technology," *Automotive Engineering*, pp.15-18, 1997.
- [10] F. Fukudome, "Technical Trends Regarding Electric Components for Electric Power Steering Systems," *Koyo Engineering Journal*, No.163, pp.32-36, 2003.
- [11] Y. Tokumoto, M. Shiba, N. Maeda, and K. Kotaka, "Development of Next-Generation Steering Sensor for Electric Power Steering," *Koyo Engineering Journal*, No.165, pp.20-24, 2004.
- [12] J. S. Chen, "Control of Electric Power Steering Systems," *SAE Paper 981116*, 1998.