

**Continuous Blood Pressure Monitoring using Pulse Wave Transit Time**

Gu-Young Jeong\*, Kee-Ho Yu\*\* and Nam-Gyun Kim\*\*\*

\* Department of Mechatronics Engineering, Chonbuk National University, Jeonju, Korea  
(Tel : +82-63-270-2471; E-mail: jung902@chonbuk.ac.kr)

\*\*Division of Mechanical and Aerospace System Engineering, Chonbuk National University, Jeonju, Korea  
(Tel : +82-63-270-2471; E-mail: yu@chonbuk.ac.kr)

\*\*\* Division of Bionics and Bioinformatics, Chonbuk National University, Jeonju, Korea  
(Tel : +82-63-270-4061; E-mail: ngkim@chonbuk.ac.kr)

**Abstract:** In this paper, we describe the method of non-invasive blood pressure measurement using pulse wave transit time(PWTT). PWTT is a new parameter involved with a vascular that can indicate the change of BP. PWTT is measured by continuous monitoring of ECG and pulse wave. No additional sensors or modules are required. In many cases, the change of PWTT correlates with the change of BP. We measure pulse wave using the photo plethysmograph(PPG) sensor in an earlobe and we measure ECG using the ECG monitoring device our made in the chest. The measurement device for detecting pulse wave consists of infrared LED for transmitted light illumination, pin photodiode as light detector, amplifier and filter. We composed 0.5Hz high pass, 60Hz notch and 10Hz low pass filter. ECG measurement device consists of multiplexer, amplifier, filter, micro-controller and RF module. After amplification and filtering, ECG signal and pulse wave is fed through micro-controller. We performed the initial work towards the development of ambulatory BP monitoring system using PWTT. An earlobe is suitable place to measure PPG signal without the restraint in daily work. From the results, we can know that the dependence of PWTT on BP is almost linear and it is possible to monitoring an individual BP continuously after the individual calibration.

**Keywords:** pulse wave transit time, blood pressure, photo plethysmograph, ECG

**1. INTRODUCTION**

In this paper, we describe the method of non-invasive blood pressure measurement using pulse wave transit time. Blood pressure is measured either invasively by an intra-arterial catheter or non-invasively by cuff sphygmomanometer. Cuff method is less accurate than arterial catheter, but it is used in most case because of convenience for measuring blood pressure. Arterial hypertension is a major problem in modern medicine and health care. Table 1 is the classification of blood pressure levels by WHO. Generally hypertension is defined as systolic blood pressure > 140 mmHg and diastolic BP > 90 mmHg. Many peoples of a hypertensive are still unaware the fact they have hypertension, mainly because of the asymptomatic nature of the disease for the first 15-25 years, even if it progressively damages the cardiovascular system [1]. For the prevention and treatment of hypertension, it is necessary to measure BP periodically. In addition, the ambulatory BP monitoring is essential for the detection of persistently elevated pressure during 2-3 hours after awakening, when the largest proportion of sudden cardiac

deaths, myocardial infarctions, and strokes occur. Commercially available wrist BP monitor that is the ambulatory BP measurement system is useful to a hypertensive and a person who manage BP. This system allows a people to measure BP themselves everywhere by simple operation. The automatic BP measurement systems based on cuff are pre-programmed to record usually at every 15-20 minutes, which can cause inconveniences at everyday activities and loss of important information between the measurements. Therefore, a continuous measurement of BP is more desirable for a hypertensive to monitoring their BP.

Potentially useful and convenient parameter for continuous monitoring of blood pressure could be pulse wave velocity or pulse wave transit time(PWTT) between different regions of human body. PWTT is a new parameter involved with a vascular that can indicate the change of BP. PWTT is measured by continuous monitoring of ECG and pulse wave. No additional sensors or modules are required. In many cases, the change of PWTT correlates with the change of BP. Usually, if BP increases, PWTT decreases and if BP becomes low, PWTT increases. It has been demonstrated that systolic blood pressure estimation from PWTT is possible with acceptable accuracy by personal calibration of the method for particular patient [2-3]. BP measurement by PWTT can be more efficient than cuff because of continuous BP recording and convenient measurement. Until now, there has been increasing interest in development of continuous BP measurement [4-7].

This paper focuses on the initial work towards the development of ambulatory BP monitoring system using PWTT. The major aim in this paper is to search for the optimal place on which the photo plethysmograph(PPG) sensor is placed and to find the relationship between PWTT and body position because it is very important to acquire the reliable and stable PPG signal from the person without the restraint in daily life. We acquire pulse wave from PPG sensor placed on an earlobe because there is less variation in the relative vertical position of a head for the heart. ECG signal is

Table 1 Classification of BP levels by WHO

Category	Systolic BP	Diastolic BP
Optimal	< 119	< 79
Normal	120 ~ 129	80 ~ 84
High-Normal	130 ~ 139	85 ~ 89
Grade I Hypertension	140 ~ 159	90 ~ 99
Subgroup: Borderline	140 ~ 149	90 ~ 94
Grade II Hypertension	160 ~ 179	100 ~ 109
Grade III Hypertension	> 180	> 110
Isolated Systolic Hypertension	> 140	< 89
Subgroup: Borderline	140 ~ 149	< 89

measured through four electrodes placed on chest

## 2. ECG AND PPG MEASUREMENT

Fig. 1 shows ECG and PPG measurement device. The measurement device for detecting pulse wave consists of PPG sensor, amplifier and filters. Infrared LED for transmitted light illumination and pin photodiode as light detector are used to make PPG sensor. The filter of 0.5Hz high pass, 60Hz notch and 10Hz low pass are used to reduce noise. ECG measurement device consists of multiplexer, amplifier, filter, micro-controller and RF module. After amplification and filtering, the ECG and PPG signals are fed through micro-controller for the data conversion process. We used PIC16C74 for micro-controller, BIM418 for RF module, AD621 for ECG amplifier, MAX291 for 40Hz low pass filter. For measuring ECG, we composed 0.5Hz high, 10Hz low pass and 60Hz notch filter using OP amp. Sampling rate is 600Hz and A/D resolution is 8bit. Available distance of RF module is 30m in building and 120m in open ground, and communication with PC is performed through serial port.

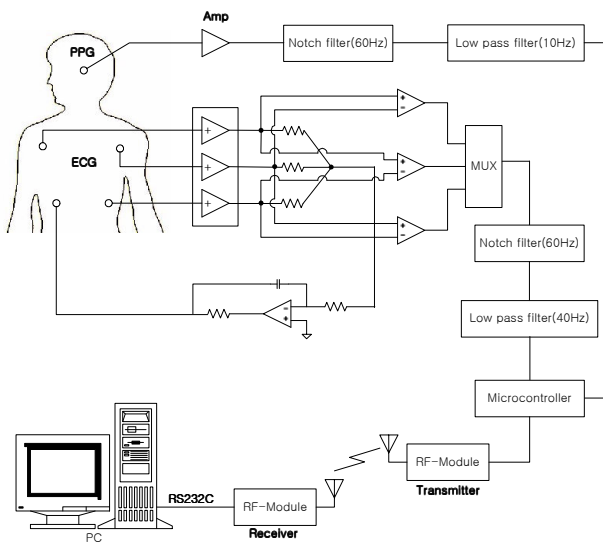

Fig. 1. ECG and PPG measurement device

## 3. PWTT DETECTION

In this paper, PWTT is defined as the time between the R peak of ECG and 50% rising point of PPG pulse as illustrated in Fig. 2.

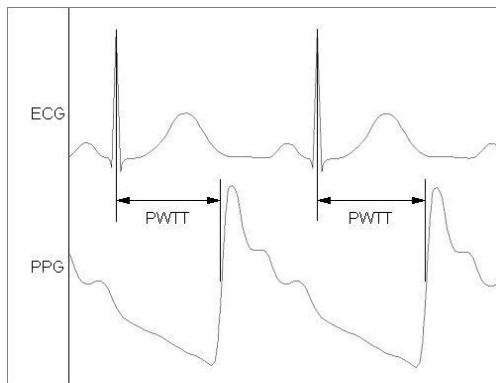

Fig. 2. The definition of PWTT

Wavelet transform is the basis for finding R peak. The wavelet transform divides an input signal into high frequency bands and low frequency bands by using a scaling function. R peak is relatively higher than the other points in high frequency bands. Therefore, R waves can be detected by observing for noticeable decrease or increase of high frequency bands. In this study, the ECG data are decomposed into three high frequency bands and one low frequency band using the daubiech wavelet function. High frequency bands are used to detect R peak, because this bands disclose the QRS complex of the ECG distinctly, and the amplitudes of QRS complex in this bands are complementary to each other. R peak is detected based on simple amplitude threshold method.

The 50% location of PPG pulse is detected using the similar searching method such as the detection of R peak, because this is the point in PPG where the change of signal is the sharpest.

## 4. PPG SENSOR LOCATION

Pulse wave velocity in arterial system is determined by vascular tone. Therefore, according to the place where PPG is placed on the body, there is some difference in PWTT. In other word, PWTT measured on the right hand maybe differ from that on the left hand. Also, the change of relative vertical position of PPG sensor for the heart brings the change of PWTT. Fig. 3 shows the distribution of vein. The true BP is measured in the aorta, but usually BP is measured in brachial artery because the route from the aorta to brachial artery is not complicate and brachial artery is closely in a heart. Most of previous studies about BP monitoring using PWTT measures PPG signal on wrist or finger, but wrist and finger have much movement in daily work. Therefore, we chose an earlobe from other place on the body. PWTT on an earlobe is the time it takes the pulse wave to travel from the aorta to a peripheral artery via common carotid artery.

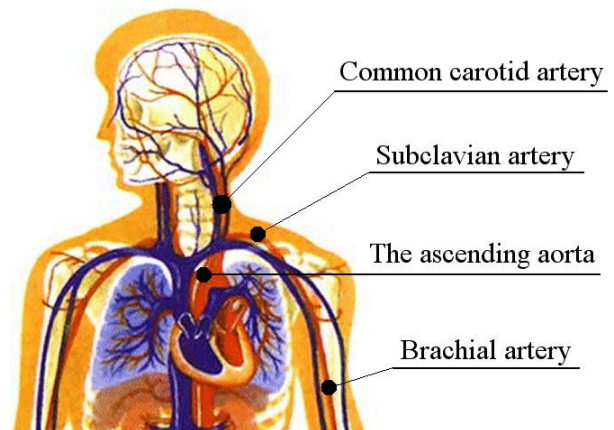

Fig. 3. Distribution of vein

## 4. RESULTS

PWTT is very sensitive to the change of the body position. Therefore, we measured PWTT in finger and earlobe with the change of the body position to find more suitable place on the body for PPG sensor. Fig. 4 shows the change of PWTT according to the elevation of arm with PPG sensor placed on finger. Also, Fig. 5 shows the change of PWTT according to the movement of the upper half of the body with PPG sensor

placed on earlobe. In both figures, PWTT is increased by elevation of the relative vertical position of PPG sensor for a heart. The maximum difference between PWTTs is 108ms in Fig.4, but that in Fig. 5 is 48ms. In case PPG sensor is placed on finger, it is necessary to compensate for arm's position. It is also necessary to compensate for head's position in case PPG sensor is placed on earlobe. However, in a human's daily life, the change of the relative vertical position of a head for a heart is not larger than the change of arm. In both figures, PWTTs are the values measured in no movement of the body. In other words, PWTT does not include the effect by acceleration in Fig. 4 and 5. We easily expect PWTT to increase during the elevation of arm or head because of acceleration. A radical difference between PWTTs in Fig. 4 and 5 is caused by the difference between travel routes of pulse wave from the aorta to each peripheral vascular. In supine position, we have acquired the smallest PWTT.

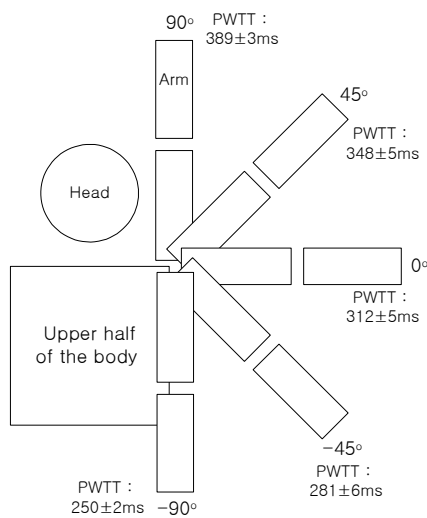

Fig. 4. PWTT on finger

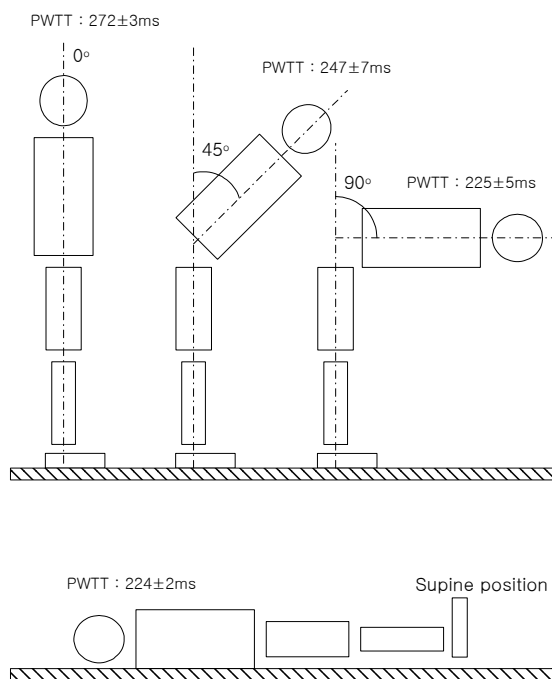

Fig. 5. PWTT on earlobe

Fig. 6 and 7 show the relation of PWTT from systolic BP in case of PPG sensor placed on earlobe. To increase the arterial blood pressure, it was used to go up and down stairs. The workload was kept until the submaximal heart rate was achieved, thereafter 5-10 minute back to normal. The recording was made throughout the recovery. BP was additionally monitored with HEM-904, OMRON. Every measurement of PWTT synchronized with every measurement of BP by HEM-904.

Subject #1 has 105 mmHg and 68 mmHg for systolic BP and diastolic, and subject #2 has 117 mmHg and 82 mmHg for systolic BP and diastolic in steady state. We can know the dependence of PWTT on earlobe from systolic BP is almost linear from Fig. 6 and 7. The least square lines in Fig. 6 and 7 can be used to estimate systolic BP from PWTT. From that result, the two lines differ each other in characteristic. We can know that the most important factor in estimation of systolic BP is individual calibration of the lines.

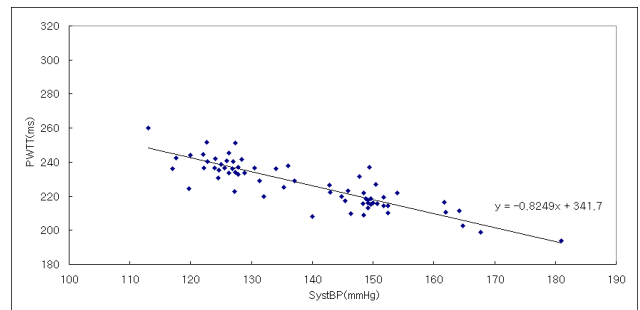

Fig. 6. The relation of PWTT from systolic BP in subject #1

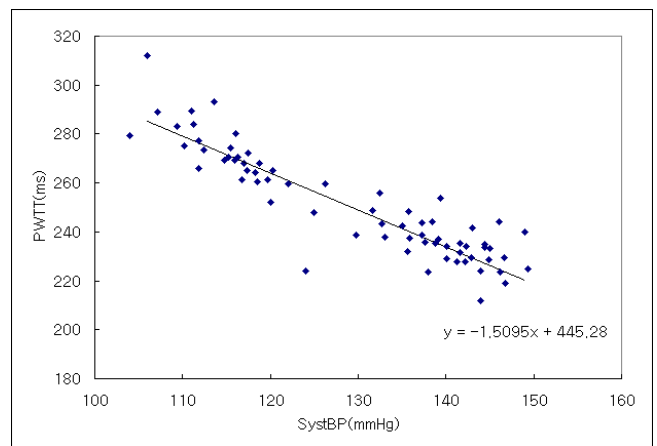

Fig. 7. The relation of PWTT from systolic BP in subject #2

### 5. CONCLUSION

Arterial hypertension is a major problem in modern medicine and health care, but more serious thing is that many peoples of a hypertensive are still unaware the fact they have hypertension. Hence, for the early detection of elevated BP and treatment of hypertension, it is necessary to measure BP periodically. PWTT is a new parameter involved with a vascular that can indicate the change of BP. Since PWTT should be inversely proportional to pulse wave velocity and BP, it is possible to monitoring BP continuously using PWTT.

We can measure PWTT in every place on the body using ECG and PPG devices. However, to measure PWTT without the restraint in daily work, we have to find the suitable place on body.

We performed the initial work towards the development of ambulatory BP monitoring system using PWTT. An earlobe is suitable place to measure PPG signal without the restraint in daily work. Also, The dependence of PWTT on earlobe from systolic BP is almost linear. That is, it is possible to monitor systolic BP continuously using PWTT on earlobe.

To estimate precise BP from PWTT, it is necessary to compensate for the change of the relative vertical position of a head for a heart.

### REFERENCES

- [1] J. Lass, K. Meigas, D. Karai, R. Kattai, J. Kaik, and M. Rossmann, "Continuous blood pressure monitoring during exercise using pulse wave transit time measurement," *Proc. of the 26th Annual International Conference of the IEEE EMBS*, pp.2239-2242, 2004.
- [2] W. Chen, T. Kobayashi, S. Ichikawa, Y. Takeuchi, and T. Togawa, "Continuous estimation of systolic blood pressure using the pulse arrival time and intermittent calibration," *Med Biol Eng Comput.*, Vol. 38, No. 5, pp. 569-574, 2000.
- [3] S. M. Lee, Y. H. Han, E. K. Park, J. Y. Lee, S. Y. Kwon, I. Y. Kim, and S. I. Kim, "Non-invasive estimation of systolic blood pressure using the pulse transit time and other parameters," *International Ubiquitous Healthcare Conference*, pp. 22-23, 2004.
- [4] P. Fung, G. Dumont, C. Ries, C. Mott, and M. Ansermino, "Continuous Noninvasive Blood Pressure Measurement by Pulse Transit Time," *Proc. of the 26th Annual International Conference of the IEEE EMBS*, pp.738-741, 2004.
- [5] C. M. Lee and Y. T. Zhang, "Cuffless and noninvasive estimation of blood pressure based on a wavelet transform approach," *IEEE EMBS Asian-Pacific Conference on Biomedical Engineering*, pp. 148-1489, 2003.
- [6] J. J. Im and C. S. Lessard, "A study for the development of a noninvasive continuous blood pressure measuring system by analyzing radial artery pulse from a wrist," *Engineering in Medicine and Biology Society IEEE 17<sup>th</sup> Annual Conference*, Vol. 2, pp. 1033-1034, 1995.
- [7] Y. T. Zhang, C. C. Y. Poon, S. D. Bao, and K. C. Lui, "A Wearable and Cuffless Device For the Continuous Measurement of Arterial Blood Pressure," *International Ubiquitous Healthcare Conference*, pp. 19-21, 2004.