

## Post Processor Using a Fuzzy Feed Rate Generator for Multi-Axis NC Machine Tools with a Rotary Unit

F. Nagata\*, Y. Kusumoto\*, K. Hasebe\*, K. Saito\*\*, M. Fukumoto\*\* and K. Watanabe\*\*\*

\*Fukuoka Industrial Technology Center, Kitakyushu, Fukuoka 807-0831, Japan  
(Tel: +81-93-691-0260; Fax: +81-93-691-0252; E-mail: {nagata, y\_kusumoto, khasebe}@fitc.pref.fukuoka.jp)

\*\*Fukumoto Kogyo Co., Ltd., Kurate, Fukuoka 807-1307, Japan  
(E-mail: {k-saito, fukumoto}@fukumotoreform.co.jp)

\*\*\*Graduate School of Science and Engineering, Saga University, Saga 840-0003, Japan  
(E-mail: watanabe@me.saga-u.ac.jp)

**Abstract:** Handy paint rollers with simple or no patterns are generally used to transcribe its design to a wall just after painting. However, the types of the patterns are limited to several conventional ones, so that interior planners' or decorators' demands are gradually tending to getting attractive roller designs. In order to obtain abundant kinds of the roller designs, a new advanced 3D machining method should be established for cylindrical models. In this paper, a post-processor that can generate suitable NC data is proposed for multi-axis NC machine tools with a rotary unit. The 3D machining system with the post-processor is also presented for an attractive interior decorating. The machining system allows us to easily transcribe the relief designs from on a flat model to on a cylindrical model. The effectiveness of the proposed 3D machining system using the post-processor is demonstrated through some machining experiments.

**Keywords:** NC machine tool, Rotary unit, Post-processor, CL data, NC data, Fuzzy reasoning, Paint roller

### 1. Introduction

In home making industry, handy paint rollers with a simple pattern are generally used to transcribe its design to a wall just after painting. However, the types of the patterns are limited to several conventional ones, so that interior planners and decorators want to use more attractive roller designs. In order to increase the kinds of the roller designs, a new advanced 3D machining system should be established for cylindrical shape. Up to now, although advanced 3D machining systems have been developed in various manufacturing industries [1], [2], [3], [4], roller models with a relief design seem not to be successfully machined at the present stage.

In this paper, a 3D machining system based on an NC machine tool with a rotary unit and its post-processor are introduced to efficiently machine attractive paint rollers. The paint rollers used in general have little or no attractive design and also their designs are limited to a flat or several simple patterns. This paper addresses how to easily make paint rollers with attractive patterns. The most important point is that proper NC data are straightforwardly generated for the rotary unit. To meet the need, a post-processor is proposed for the NC machine tool with a rotary unit. The post-processor transforms the base cutter path called cutter location data to the NC data, mapping the *y*-directional pick feed to the rotational angle of the rotary unit. The 3D machining system with the post-processor allows us to easily transcribe the relief designs from a flat model surface to a cylindrical model surface. The post-processor has another function that automatically adjusts the feed rate according to the curvature of each model to shorten the cycle time for machining. The post-processor generates suitable feed rates by using a simple fuzzy reasoning method. Experimental results show that attractively designed relief paint rollers can

be successfully machined.

### 2. 3D machining system based on an NC machine tool with a tilting head

In this section, a 3D machining system based on a 5-axis NC machine tool with a tilting head, which is one of the most representative and popular machine tools in manufacturing industry of woody materials, is introduced. The machining system consists of a 3D CAD/CAM with variable axis function and a post-processor. Figure 1 shows the 5-axis NC machine tool (HEIAN FF-151MC). The NC machine tool has a tilting head that can be simultaneously inclined and rotated. It should be noted however that corrected NC data are required to run the NC machine tool as computer simulation. The post-process means to generate the corrected NC data from cutter location data (CL data). Figure 2 shows the general process to generate the corrected NC data for the 5-axis NC machine tool. As an example, a relief design



Fig. 1. 5-axis NC machine tool with a tilting head.

This work was funded by Fukuoka Coal Industry Promotion Center in 2004.

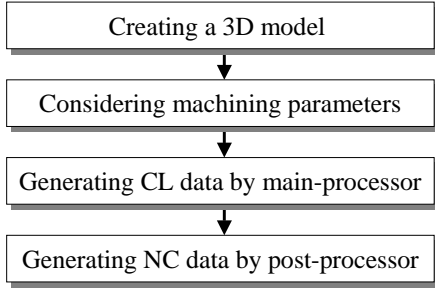

Fig. 2. General process to generate corrected NC data for 5-axis NC machine tool.

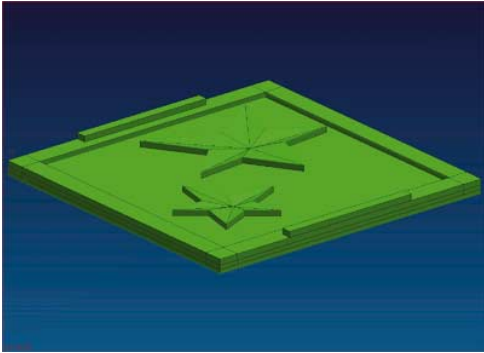

Fig. 3. Relief design illustrated by a 3D CAD.

is given as shown in Fig. 3. We first draw the model for the relief design using a 3D CAD. Secondly, the CAM parameters such as pick-feed, path pattern (e.g., zigzag path), tolerance and so on are set according to the actual machining required. The main-processor of the CAM calculates a cutter path using the parameters. The cutter path is called CL data. The CL data in the  $i$ -th step is composed of position and normal vectors written by

$$\begin{aligned} \mathbf{CL}(i) &= [x(i) \ y(i) \ z(i) \ v_x(i) \ v_y(i) \ v_z(i)]^T \quad (1) \\ \{v_x(i)\}^2 + \{v_y(i)\}^2 + \{v_z(i)\}^2 &= 1 \quad (2) \end{aligned}$$

Finally, our proposed post-processor generates the corrected NC data for the 5-axis NC machine tool with a tilting head, by only considering a tool length [5]. Figure 4 shows the tiltable main head which has a ball-end mill at the tip. The tool length  $L_1 + L_2$  is defined as the distance from the center of swing to the tip of the end mill, which should be measured in advance. The proposed post-processor transforms the CL data into NC data for 5-axis NC machine tools as shown in Fig. 1. The main head can be inclined and rotated in the range  $\pm 90$  and  $\pm 180$  degrees, respectively. The inclined and rotated axes are called the 4-th (B) and 5-th (C) axes, respectively. The corrected NC data in the  $i$ -th step are written by

$$\begin{aligned} \mathbf{NC}(i) &= [\tilde{x}(i) \ \tilde{y}(i) \ \tilde{z}(i) \ b(i) \ c(i)]^T \quad (3) \\ \tilde{j}(i) &= j(i) + v_j(i)(L_1 + L_2), \quad j = x, y, z \quad (4) \end{aligned}$$

where  $b(i)$  and  $c(i)$  are the head angles of the inclination and rotation as shown in Fig. 5, respectively. The CL data

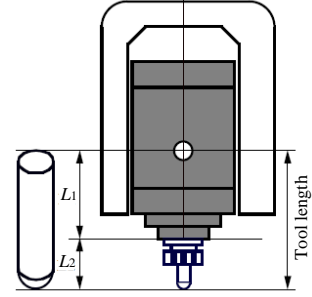

Fig. 4. The definition of the tool length for 5-axis NC machine tool.

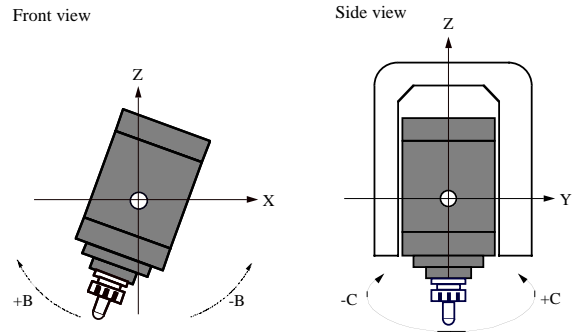

Fig. 5. Inclination and rotation of main head.

generated from the main processor of the CAM are composed of sequential points on the model surface as shown in Fig. 6. If the NC data are transformed from the CL data without considering the tool length and are directly given to the NC machine tool, then the center of swing is reduced to follow the NC data directly. As can be expected, this would bring out a serious and undesirable interference between the main head and the workpiece. On the contrary, if the center of swing follows the corrected NC data given by (3), the tip of the end mill can desirably move along the model surface as shown in Fig. 6.

Recently, such a 5-axis NC machine tool with a tilting head has become a center of attraction in manufacturing industry of woody materials. However, it has been recognized from machining experiments that the 5-axis NC machine tool is not good at machining roller models as shown in Fig. 7.

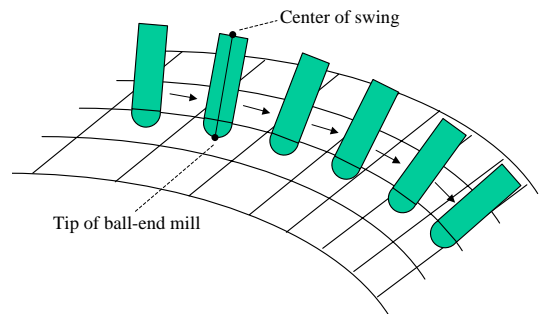

Fig. 6. Motion of tip of end mill (CL data) generated from main-processor.

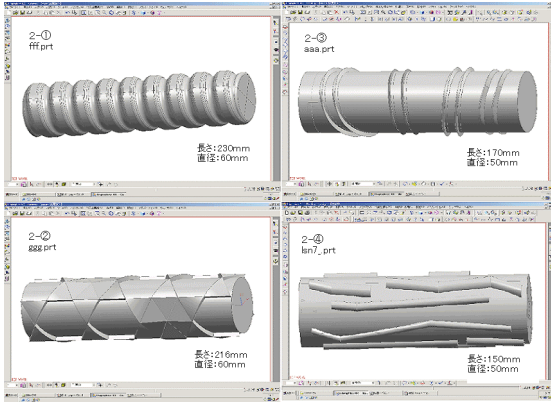

Fig. 7. Roller models designed by a 3D CAD.

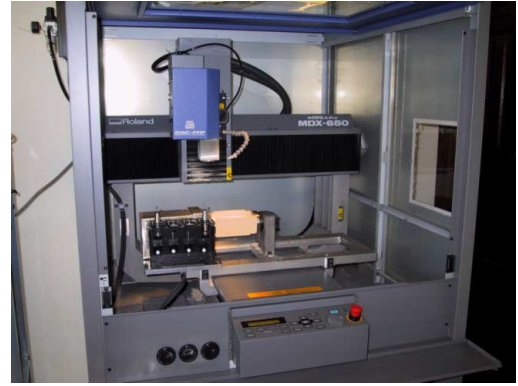

Fig. 8. NC machine tool MDX-650A with a rotary unit.

Although its high machining performance beyond the capability of standard NC machine tools is expected, it has been hardly used for roller models yet. The main reasons are that the roller models as shown in Fig. 7 can not be machined with one time, i.e., the models must be machined with several re-positioning; the 3D modeling for rollers is so complicated and time-consuming. To overcome this problem, a 3D machining system based on an NC machine tool with a rotary unit is introduced in the next section.

### 3. 3D machining system based on an NC machine tool with a rotary unit

In this section, a 3D machining system based on an NC machine tool with a rotary unit and its post-processor are introduced to efficiently machine cylindrical models. The machined models can be used as elaborately designed paint rollers. The paint roller is very useful and convenient to directly transcribe relief designs to a wall just after painting. However, the paint rollers used in general have little or no attractive designs and also their designs are limited to a flat or several simple patterns. Unfortunately, the 5-axis NC machine tool introduced in previous section is not good at machining cylindrical shapes. To solve this problem, a post-processor is proposed for the NC machine tool with a rotary unit. The post-processor allows the NC machine tool to produce elaborately designed paint rollers. Attractive 3D designs drawn on a flat model surface can be easily transcribed to a cylindrical model surface.

First of all, we introduce an NC machine tool MDX-650A provided by Roland D.G. as shown in Fig. 8. The NC machine tool equips with an auto tool changer ZAT-650 and a rotary unit ZCL-650A. The mechanical resolution of the rotary unit is about 0.0027 degrees. The NC machine tool has four degrees of freedom, i.e., three translations and one rotation. In order to present many kinds of paint rollers with high variety and low volume manufacturing, such a machining system that can directly machine a relief design on a cylindrical workpiece must be realized.

Next, we discuss the problem concerning the 3D machining of cylindrical shape with a relief design. When the modeling of roller is conducted by using a 3D CAD, a base cylindrical

model is provided in advance. Then a favorite relief design is drawn on the cylindrical model. However, the relief design on the cylindrical shape is so difficult and complicated task even if using any 3D CAD. Furthermore, its 3D machining is also more difficult even if using the 5 axis NC machine tool as shown in Fig. 1, in which NC data generated from the CAM are composed of  $x$ -,  $y$ -,  $z$ -,  $b$ - and  $c$ - directional components.

This paper addresses how to easily make a paint roller with an attractive relief design. The most important point is that proper NC data for the NC machine tool with a rotary unit can be generated straightforwardly. To meet the need for the NC machine tool with a rotary unit, a post-processor is proposed to successfully transcribe the design on a flat model to on a cylindrical model. The post processor allows us to directly machine a relief design on a cylindrical workpiece. We here describe the characteristics of the post-processor. A relief design is first modeled on a flat base model as shown in Fig. 3. CL data are secondly generated with a zigzag path as shown in Figs. 9 and 10. Its pick feed is given by  $y_{pick}$ . In this case, the coordinate system should be set so that the pick feed direction is parallel to the table slide direction of the NC machine tool, i.e.,  $y$ -direction. The proposed post-processor transforms the CL data into NC data as shown in Fig. 11, mapping the  $y$ -directional position to the rotational angle of the rotary unit. As can be seen from the components of the

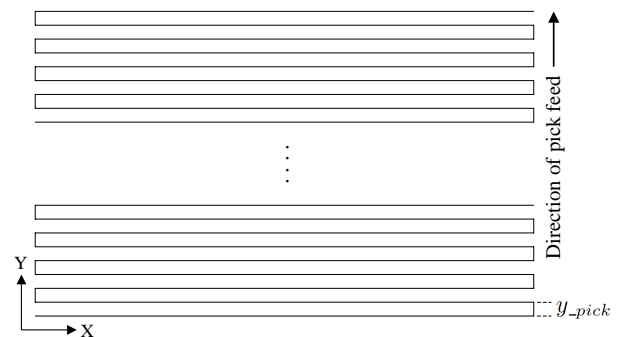

Fig. 9. Zigzag path on a flat model as shown in Fig. 3, where note that the  $z$ -directional position changes according to the shape of each model.

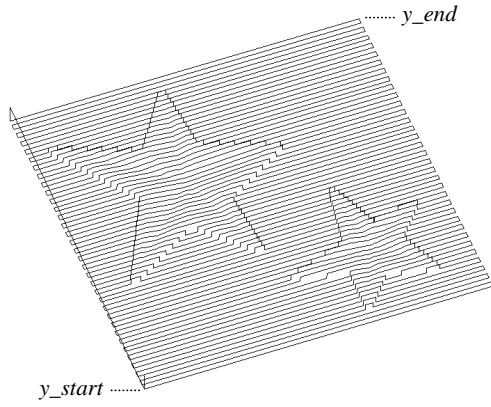

Fig. 10. Example of zigzag path on a flat model ( $x$ - $y$ - $z$  view).

<pre>GOTO/ X223.2544Y21.3217Z2.6043 GOTO/ X223.3843Y21.3217Z2.1187 GOTO/ X223.3861Y21.3217Z0.0000 GOTO/ X231.4419Y21.3217Z0.0000 GOTO/ X231.4419Y21.6216Z0.0000 GOTO/ X223.3861Y21.6216Z0.0000 GOTO/ X223.3843Y21.6216Z2.1187 GOTO/ X223.2544Y21.6216Z2.6035</pre>	→	<pre>G01X223.2544A42.8410Z2.6043 G01X223.3843A42.8410Z2.1187 G01X223.3861A42.8410Z0.0000 G01X231.4419A42.8410Z0.0000 G01X231.4419A43.4054Z0.0000 G01X223.3861A43.4054Z0.0000 G01X223.3843A43.4054Z2.1187 G01X223.2544A43.4054Z2.6035</pre>
--	---	--

Fig. 11. Mapping of NC data from flat model to roller model.

NC data, when the rotary unit is active, the  $y$ -directional motion is inactive. The post-processor first checks all steps in CL data, and extracts the minimum value  $y_{min}$  and the maximum value  $y_{max}$  in  $y$ -direction. The angle  $a(i)$  for the rotary unit is obtained from

$$a(i) = \frac{360 \times \{y(i) - y_{min}\}}{y_{length}} \quad (5)$$

where  $y_{length}$  is the length in  $y$ -direction and is easily obtained by  $y_{max} - y_{min}$ . The CL data in the  $i$ -th step  $[x(i) \ y(i) \ z(i)]^T$  is transformed into the NC data composed of  $[x(i) \ a(i) \ z(i)]^T$  by using (5). The length in  $y$ -direction is translated into the circumference of the roller model. The transformation image from the  $y$ -directional pick feed to the



Fig. 12. Machining scene by using the proposed system.



Fig. 13. A wooden roller machined by the proposed 3D machining system.

angle of the rotary unit is shown in Fig. 11. Figures 12 and 13 show the machining scene by using the proposed system and the roller machined, respectively. It is confirmed that the relief design shown in Fig. 3 is desirably machined on the surface of the cylindrical workpiece. The proposed system provides a function that easily transcribes an attractive design from on a flat model to on a cylindrical workpiece fixed to the rotary unit.

## 4. Fuzzy feed rate generator

### 4.1. Feed rate control according to curvature

It is known that an F-code such as F3000.0 (i.e., 3000 mm/min) is generally used to set the tool's feed rate to an NC machine tool. The feed rate is one of the most important parameters to smoothly control NC machine tools and to reduce the total machining time. Although the feed rate should be set as fast as possible, if the cutter path has large curvature or small edge (e.g., pick feed  $y_{pick}$  as shown in Fig. 9) then undesirable vibrations and noises would occur. This means that the machining accuracy tends to go down and we can't obtain the precise shape as the model designed by a 3D CAD. Conventional post-processors have not possessed a function to append the feed rate systematically. In this section, an approach is introduced to automatically generate the feed rate. The proposed post-processors have a function that automatically adjusts the feed rate according to the curvature of each model to shorten the total time for machining. Figure 14 shows an example of CL data generated from a 3D CAD/CAM. The CL data are calculated with a linear approximation. Generally, the main-processor of a CAM calculates the cutter path  $\mathbf{p}(i) = [x(i) \ y(i) \ z(i)]^T$  so that the workpiece can be machined within a tolerance to a designed model. Therefore, larger the curvature is, higher its point density is. Accordingly, considering the curvature results in acquiring the distance  $d(i) = \|\mathbf{p}(i+1) - \mathbf{p}(i)\|$  between two adjacent steps of the NC data and its increment  $\Delta d(i) = d(i+1) - d(i)$ .

### 4.2. Fuzzy feed rate generator

In this section, we propose a fuzzy feed rate generator that generates suitable feed rate codes according to  $d(i)$  and

Table 1. Consequent constants of fuzzy reasoning for  $d(i)$  and  $\Delta d(i)$ .

$c_1^A$	$c_2^A$	$c_3^A$	$c_4^A$	$c_5^A$	$c_6^A$
$F_{\min} + 0.1F_{base}$	$F_{\min} + 0.2F_{base}$	$F_{\min} + 0.4F_{base}$	$F_{\min} + 0.6F_{base}$	$F_{\min} + 0.8F_{base}$	$F_{\min} + F_{base}$
$c_1^B$	$c_2^B$	$c_3^B$	$c_4^B$	$c_5^B$	$c_6^B$
$-0.5F_{\min}$	$-0.2F_{\min}$	$-0.1F_{\min}$	$0.1F_{\min}$	$0.2F_{\min}$	$0.5F_{\min}$

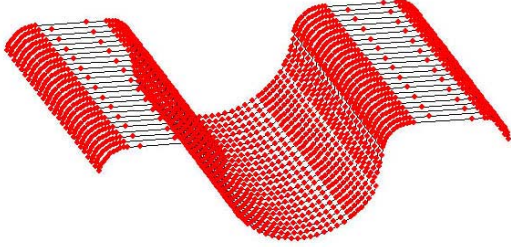

Fig. 14. Relation between the distance and the point density with respect to the CL data.

$\Delta d(i)$ . The fuzzy feed rate generator consists of two simple fuzzy reasoning parts whose consequent parts are constant. When the current position  $\mathbf{X}(k) = [X(k) Y(k) Z(k)]^T$  of the end mill at the discrete time  $k$  is  $\mathbf{X}(k) \in [\mathbf{p}(i), \mathbf{p}(i+1)]$ , the fuzzy rules are described by

Rule 1 IF  $d(i)$  is  $\tilde{A}_1$  THEN  $F(i) = c_1^A$   
 Rule 2 IF  $d(i)$  is  $\tilde{A}_2$  THEN  $F(i) = c_2^A$

$\vdots$

Rule  $L$  IF  $d(i)$  is  $\tilde{A}_L$  THEN  $F(i) = c_L^A$

and

Rule 1 IF  $\Delta d(i)$  is  $\tilde{B}_1$  THEN  $\Delta F(i) = c_1^B$   
 Rule 2 IF  $\Delta d(i)$  is  $\tilde{B}_2$  THEN  $\Delta F(i) = c_2^B$

$\vdots$

Rule  $L$  IF  $\Delta d(i)$  is  $\tilde{B}_L$  THEN  $\Delta F(i) = c_L^B$

where  $\tilde{A}_j (j = 1, \dots, L)$  and  $\tilde{B}_j$  are the  $j$ -th antecedent fuzzy sets for two fuzzy inputs  $d(i)$  and  $\Delta d(i)$ ;  $c_j^A$  and  $c_j^B$  are the consequent constants at the  $j$ -th rule for the feed rate  $F(i)$  and its compensation  $\Delta F(i)$ ;  $L$  is the fuzzy rule number. The confidence of each antecedent part at the  $i$ -th rule is obtained by

$$\omega_j^A = \mu_{A_j}\{d(i)\} \quad (6)$$

$$\omega_j^B = \mu_{B_j}\{\Delta d(i)\} \quad (7)$$

where  $\mu_X(\bullet)$  denotes the confidence of a fuzzy set labeled by  $X$ . Therefore, the fuzzy reasoning results for the feed rate and its compensation are respectively calculated by

$$F(i) = \frac{\sum_{j=1}^L \omega_j^A c_j^A}{\sum_{k=1}^L \omega_k^A} \quad (8)$$

$$\Delta F(i) = \frac{\sum_{j=1}^L \omega_j^B c_j^B}{\sum_{k=1}^L \omega_k^B} \quad (9)$$

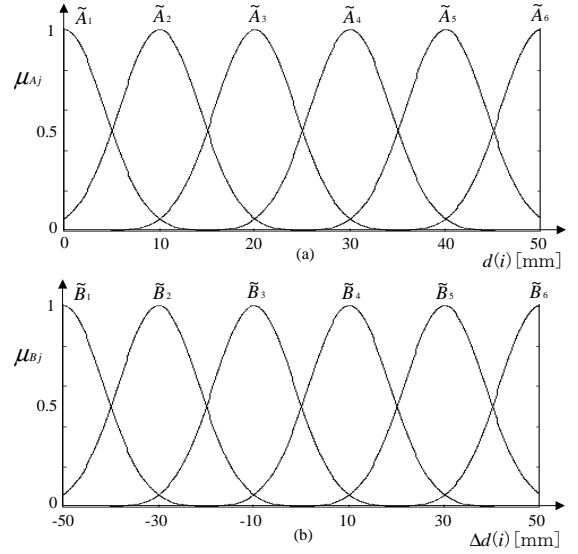

Fig. 15. Antecedent membership functions for  $d(i)$  and  $\Delta d(i)$ .

The resultant fuzzy feed rate  $\tilde{F}(i)$  is realized in the form

$$\tilde{F}(i) = F(i) + \Delta F(i) \quad (10)$$

Note that the fuzzy set used is the following Gaussian membership function

$$\mu_X(x) = \exp\{\log(0.5)(x - p)^2 q^2\} \quad (11)$$

where  $p$  is the center of membership function and  $q$  is the reciprocal value of standard deviation. Figures 15 (a) and (b) show the antecedent membership functions designed for  $d(i)$  and  $\Delta d(i)$ , respectively. The reciprocal values of the standard deviations are 0.2 and 0.1, respectively. The corresponding constant values in consequent parts are tabulated in Table 1, in which  $F_{\max}$  and  $F_{\min}$  are the maximum and minimum values for the feed rate estimated in advance;  $F_{base}$  denotes  $F_{\max} - F_{\min}$ . These fuzzy rules are tuned based on the experience of a skilled NC operator. Note that the fuzzy reasoning part yields not only larger values than  $F_{\max}$  but also smaller values than  $F_{\min}$  with the combination of  $d(i)$  and  $\Delta d(i)$ .

## 5. Experiments

Experiments using the proposed post-processor were conducted through actual machining of cylindrical workpieces. Figure 16 shows the machined paint rollers. Figure 17 shows one of the results, where the feed rates are generated from the fuzzy feed rate generator described in previous section. It

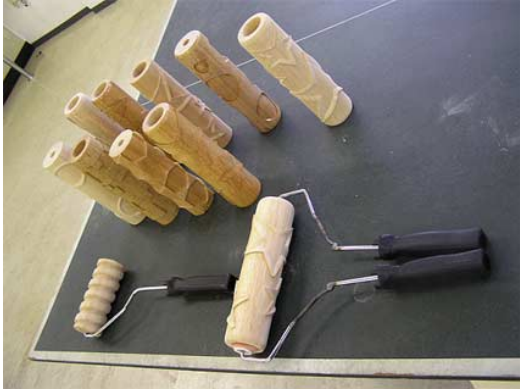

Fig. 16. Paint rollers machined by the proposed system.



Fig. 18. Examples of relief panels.

## 6. Conclusion

In this paper, a post-processor using a fuzzy feed rate generator has been proposed for an NC machine tool with a rotary unit. The post-processor allowed us to easily transcribe a relief design from on a flat model to on a cylindrical workpiece. The fuzzy feed rate generator also generated feed rate codes according to the curvature of the relief design, so that the total machining time could be drastically reduced. Experimental results showed that attractively designed relief paint rollers could be successfully machined by using the proposed 3D machining system.

## References

- [1] Y. Takeuchi and T. Watanabe, "Study on post-processor for 5-axis control machining," *Journal of the Japan Society for Precision Engineering*, Vol. 58, No. 9, pp. 1586–1592, 1992 (in Japanese).
- [2] Y. Takeuchi, K. Wada, T. Hisaki and M. Yokoyama, "Study on post-processor for 5-axis control machining centers —In case of spindle-tilting type and table/spindle-tilting type," *Journal of the Japan Society for Precision Engineering*, Vol. 60, No. 1, pp. 75–79, 1994 (in Japanese).
- [3] X. J. Xu, C. Bradley, Y. F. Zhang, H. T. Loh and Y. S. Wong, "Tool-path generation for five-axis machining of free-form surfaces based on accessibility analysis," *International Journal of Production Research*, Vol. 40, No. 14, pp. 3253–3274, 2002.
- [4] S. L. Chen, T. H. Chang, I. Inasaki and Y. C. Liu, "Post-processor development of a hybrid TRR-XY parallel kinematic machine tool," *The International Journal of Advanced Manufacturing Technology*, Vol. 20, No. 4, pp. 259–269, 2002.
- [5] F. Nagata and K. Watanabe, "Development of a post-processor module of 5-axis control NC machine tool with tilting-head for woody furniture," *Journal of the Japan Society for Precision Engineering*, Vol. 62, No. 8, pp. 1203–1207, 1996 (in Japanese).

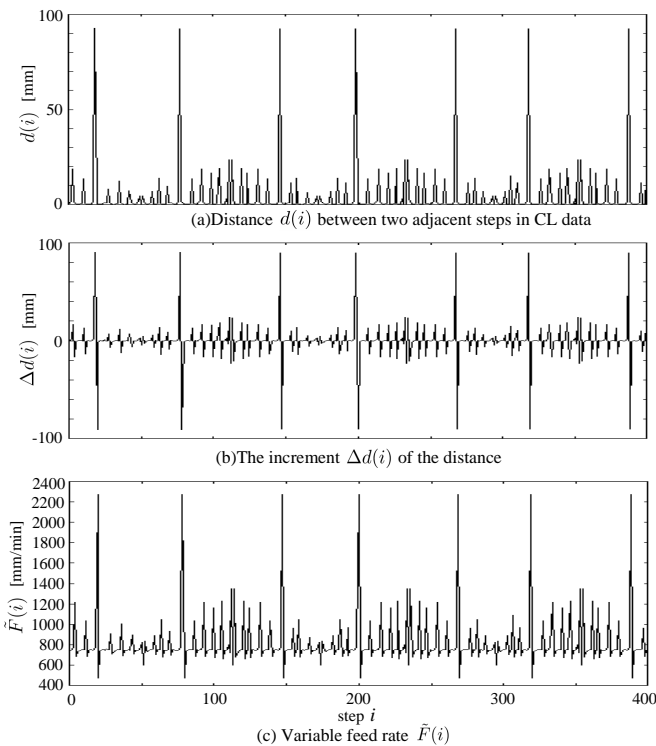

Fig. 17. An example of the variable feed rate, in which the total number of step is 400,  $F_{\max} = 2000$  and  $F_{\min} = 600$ .

is observed from the result that the feed rate  $\tilde{F}(i)$  is suitably varied according to the curvature of the surface. Note that the periodically appeared feed rate 600 mm/min is forcibly given every pick feed motion, where the rotary unit is rotated with a small angle, e.g., 0.56 degrees. The quantity of the small angle depends on the ratio of  $y_{\text{length}}$  to  $y_{\text{pick}}$ . In the case of Fig. 17, the total machining time was reduced about 20% compared with the case of using a constant feed rate 600 mm/min. As can be seen, the proposed fuzzy feed rate generator provides a more intuitive and finely tunable feed rate function for post-processor. Figure 18 shows examples of relief panels formed by the paint rollers.