

# A Method for Measuring Nonlinear Characteristics of a Robot Manipulator Having Two-degree-of-freedom

H. Harada \*, Y. Toyozawa \*\* and H. Kashiwagi †

\* Graduate School of Science and Technology, Kumamoto University, Kurokami 2-39-1, Kumamoto, 860-8555, Japan  
(Tel: +81-96-342-3747; Fax: +81-96-342-3729; Email: hiroshi@mech.kumamoto-u.ac.jp)

\*\* FANUC Corp., Kyushu Branch Office, Tsukure2570-2, Kikuyo-machi, Kumamoto, 860-1196, Japan  
(Tel/Fax: +81-96-342-3742; Email: Toyozawa.Yukio@fanuc.co.jp)

† Kumamoto Study Center, The University of the Air, Ikeda4-22-1, Kumamoto, 860-0082, Japan  
(Tel: +81-96-359-4890; Fax: +81-96-359-5114; Email: c43a00@u-air.ac.jp)

**Abstract:** The authors have recently developed a method for identification of Volterra kernels of nonlinear systems by using M-sequence and correlation technique. In this paper, we apply the proposed method to identification of a robot manipulator which has two degrees of freedom. From the results of the experiment, the nonlinear characteristics of the robot manipulator can be identified by the proposed method.

**Keywords:** Manipulator, Nonlinear system, M-sequence, Volterra kernel, Identification

## 1. Introduction

Many classes of nonlinear systems can be represented by Volterra series. In general, a lot of nonlinear systems can be expressed by Volterra series. Many researches have been performed concerning the method of measuring the Volterra series. Barker *et al.* suggested a method for obtaining 2nd order Volterra kernel by using pseudorandom antisymmetric M-sequence [1]. Shi and Hecox proposed a method for measuring Volterra kernels of the brainstem auditory evoked response by use of m-pulse [2]. One of the authors has proposed a method to identify Volterra kernels of up to 3rd order by using M-sequence and cross-correlation function [3]. In the proposed method, an M-sequence is applied to the nonlinear system to be identified and the cross-correlation function between the input M-sequence and the system output is calculated. It was shown that the obtained cross-correlation function includes not only the impulse response of the system but also cross-sections of Volterra kernels.

In this paper, we apply the proposed method to identification of a robot manipulator which has two degrees of freedom. A robot manipulator is one of the most frequently used mechanical systems in manufacturing industry. Although the dynamical property of the robot manipulator is nonlinear, it is usually treated as a linear system. So when we would like to control the robot manipulator accurately, we have to take into account about the nonlinear dynamical properties of the manipulator. The authors have already shown that the Volterra kernels of a robot manipulator can be obtained by the proposed method through computer simulations [4]. However, we did not apply the method to an actual robot manipulator. So, in order to show that this method was effective to an actual system, we made a robot manipulator which has two degrees of freedom.

In section 2, we review the method for identification of Volterra kernels of nonlinear systems by using M-sequence and correlation technique. A simple model of a two-degree-of-freedom manipulator is introduced and the motion equation for the manipulator is derived in section 3. Experiment-

tal setup used in this paper and the results of the experiment are described in section 4. Finally, in section 5, we summarize the obtained results.

## 2. Identification of Volterra Kernels

Let  $u(t)$  and  $y(t)$  be the input and the output of the nonlinear system, respectively. In this paper, we identify a nonlinear system where the input  $u(t)$  and the output  $y(t)$  satisfy the following equation.

$$y(t) = \sum_{i=1}^{\infty} \int_0^{\infty} \cdots \int_0^{\infty} g_i(\tau_1, \dots, \tau_i) \times u(t - \tau_1) \cdots u(t - \tau_i) d\tau_1 \cdots d\tau_i. \quad (1)$$

Here,  $g_i(\tau_1, \tau_2, \dots, \tau_i)$  is the  $i$ -th order Volterra kernel. When an  $n$ -th degree M-sequence is applied to the nonlinear system, the cross-correlation function  $\phi_{uy}(\tau)$  between the input  $u(t)$  and the output  $y(t)$  can be calculated as follows.

$$\begin{aligned} \phi_{uy}(\tau) &= \overline{u(t - \tau)y(t)} \\ &= \sum_{i=1}^{\infty} \int_0^{\infty} \cdots \int_0^{\infty} g_i(\tau_1, \dots, \tau_i) \\ &\quad \times \overline{u(t - \tau)u(t - \tau_1) \cdots u(t - \tau_i)} d\tau_1 \cdots d\tau_i \\ &= \sum_{i=1}^{\infty} \int_0^{\infty} \cdots \int_0^{\infty} g_i(\tau_1, \dots, \tau_i) \\ &\quad \times \phi_{uu \cdots u}(\tau, \tau_1, \dots, \tau_i) d\tau_1 \cdots d\tau_i \end{aligned} \quad (2)$$

Here,  $\overline{\quad}$  means time average over  $N\Delta t$ , where  $N$  is a period of the M-sequence and  $\Delta t$  is the time increment.  $\phi_{uu \cdots u}(\tau, \tau_1, \dots, \tau_i)$  denotes the  $(i + 1)$ -th moment of the input  $u(t)$  and can be written as

$$\phi_{uu \cdots u}(\tau, \tau_1, \dots, \tau_i) = \begin{cases} 1 & (\text{for certain } \tau) \\ -1/N & (\text{otherwise}) \end{cases} \quad (3)$$

Then, the cross-correlation function  $\phi_{uy}(\tau)$  can be approximated as

$$\phi_{uy}(\tau) \simeq \Delta t g_1(\tau) + F_3(\tau)$$

$$\begin{aligned}
& +2! \sum_{j=1}^{m_2} (\Delta t)^2 g_2(\tau - d_{21}^{(j)} \Delta t, \tau - d_{22}^{(j)} \Delta t) \\
& +3! \sum_{j=1}^{m_3} (\Delta t)^3 g_3(\tau - d_{31}^{(j)} \Delta t, \tau - d_{32}^{(j)} \Delta t, \tau - d_{33}^{(j)} \Delta t).
\end{aligned} \tag{4}$$

Here,  $F_3(\tau)$  is the 3rd order Volterra kernel having the same time coordinate. The integers  $d_{ir}^{(j)}$  satisfy the next equation and  $m_i$  is the number of  $d_{ir}^{(j)}$ .

$$u(\tau)u(\tau + d_{i1}^{(j)} \Delta t) \cdots u(\tau + d_{ii-1}^{(j)} \Delta t) = u(\tau + d_{ii}^{(j)} \Delta t) \tag{5}$$

The group of numbers can be uniquely determined by the characteristic polynomial of the M-sequence. This property is called "shift and add property" of the M-sequence [5].

### 3. A Simple Model of a Robot Manipulator

In this paper, we attempt to identify the Volterra kernels of a manipulator having two degrees of freedom. A simple model of a two-degree-of-freedom robot manipulator is shown in Fig. 1.

The robot is suspended from a ceiling at the joint  $J_1$ , where a driving motor applies the torque  $T_1$ . The parameters shown in Fig. 1 are as follows:

- $J_i$  : joint of each link
- $l_i$  : length of each link
- $m_i$  : mass of each link
- $q_i$  : angle of each link with respect to neutral line
- $s_i$  : distance between the center of gravity and the joint of each link
- $T_i$  : torque applied at each link
- $c_i$  : damping coefficient at each link
- $I_i$  : moment of inertia of each link around each joint

The motion equation for the manipulator is given by

$$T_1 = \frac{d}{dt} \{ (I_1 + m_2 l_1^2) \dot{q}_1 + I_2 (\dot{q}_1 + \dot{q}_2) \}$$

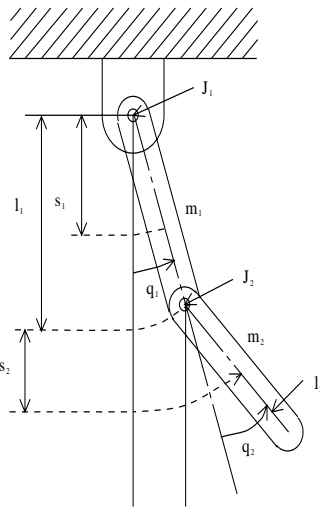

Fig. 1. A simple model of a robot manipulator

$$\begin{aligned}
& +m_2 l_2 s_2 (2\dot{q}_1 + \dot{q}_2) \cos q_2 \} + c_1 \dot{q}_1 \\
& + (m_1 s_1 + m_2 l_1) g \sin q_1 + m_2 s_2 g \sin(q_1 + q_2)
\end{aligned} \tag{6}$$

$$\begin{aligned}
T_2 = \frac{d}{dt} \{ & I_2 (\dot{q}_1 + \dot{q}_2) + m_2 l_1 s_2 \cos q_2 \} \\
& + m_2 l_1 s_2 \dot{q}_1 (\dot{q}_1 + \dot{q}_2) \sin q_2 + m_2 s_2 g \sin(q_1 + q_2).
\end{aligned} \tag{7}$$

Let us consider the case where  $q_2 = \text{constant}$  and  $\dot{q}_2 = 0$ , for simplicity. The motion of equation for the first link becomes the following equation.

$$\begin{aligned}
T_1 = & (I_1 + I_2 + m_2 l_1^2 + 2m_2 l_1 s_2 \cos q_2) \ddot{q}_1 + c_1 \dot{q}_1 \\
& + (m_1 s_1 + m_2 l_1) g \sin q_1 + m_2 s_2 g \sin(q_1 + q_2)
\end{aligned} \tag{8}$$

Since a trigonometric function is a nonlinear function, eqn. (8) becomes a nonlinear differential equation.

### 4. Experimental Results

In order to show that the proposed method was effective to an actual system, we made a robot manipulator which has two degrees of freedom. The schematic configuration of the robot manipulator is shown in Fig. 2.

The experimental system consists of two links and two joints which were driven by AC servo motors, reduction gears and mechanical couplings. Joint  $i$  ( $i = 1, 2$ ) in Fig. 2 corresponds to  $J_i$  shown in Fig. 1. The parameters shown in Fig. 2 are as follows:

- $I_{Li}$  : moment of inertia of each reduction gear
- $I_{Mi}$  : moment of inertia of each link around each joint
- $k_i$  : reduction ratio of each reduction gear
- $\omega_i$  : angular velocity of each motor shaft
- $b_i$  : damping coefficient at each reduction gear

The relation between the angular velocity  $\dot{q}_i$  of each link and the angular velocity of each motor shaft is given by

$$\dot{q}_i = \omega_i / k_i. \tag{9}$$

Then, the motion of equation for the first link shown in Fig. 2 becomes the following equation.

$$T_1 = (k_1^2 I_{M1} + I_{L1} + I_{L2} + m_2 l_1^2 + 2m_2 l_1 s_2 \cos q_2) \ddot{q}_1$$

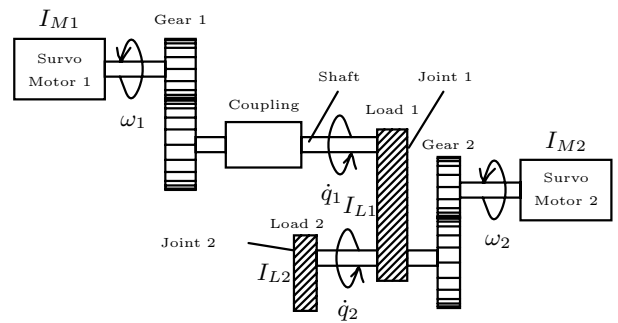

Fig. 2. Schematic configuration of the robot manipulator having two degrees of freedom



Fig. 3. Photo of the experimental system used in this paper

$$\begin{aligned}
 &+(k_1^2 b_1 + c_1)\dot{q}_1 + (m_1 s_1 + m_2 l_1)g \sin q_1 \\
 &+m_2 s_2 g \sin(q_1 + q_2)
 \end{aligned} \quad (10)$$

A personal computer sends the torque command to the driver of the AC motors. A rotary encoder was attached to each axis of the link to measure the rotation angles  $q_i$  of the joints. The photograph of the experimental system is shown in Fig. 3.

The experiments were carried out according to the following way. From motion equation of the manipulator, it is clear that there exist nonlinear characteristics between the applied torque  $T_i$  and the rotation angle  $q_i$ . In the experimental system, we used torque controlled AC motors to drive each link of the manipulator. Torque command  $v_1$  which was modulated by a 16-th order M-sequence was given to the controller of the AC motor which drives the first link. The characteristic polynomial  $f(x)$  of the M-sequence is given by

$$f(x) = x^{16} + x^{13} + x^{11} + x^{10} + x^9 + x^6 + x^4 + x^3 + 1. \quad (11)$$

The time increment  $\Delta t$  is equal to 0.05 [s]. The rotation angle  $q_1$  of the first joint were measured by using a rotary encoder attached to the axis of the first joint. In this case, the input of the nonlinear system was the torque command  $v_1$  and the output of the nonlinear system was the rotation angle  $q_1$  of the first joint. A simplified block diagram of the manipulator is described in Fig. 4 Since the proposed method can apply to a SISO nonlinear system, the rotation angle  $q_2$  of the second link was fixed during the experiment.

The cross-correlation function  $\phi_{vq}(\tau)$  between the torque command  $v_1$  and the rotation angle  $q_1$  of the first joint was calculated. The obtained crosscorrelation function is shown in Fig. 5. In this case, the rotation angle  $q_2$  of the second link

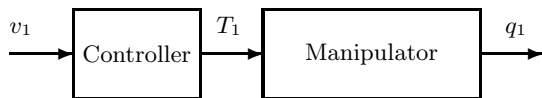

Fig. 4. A simplified block diagram of the manipulator

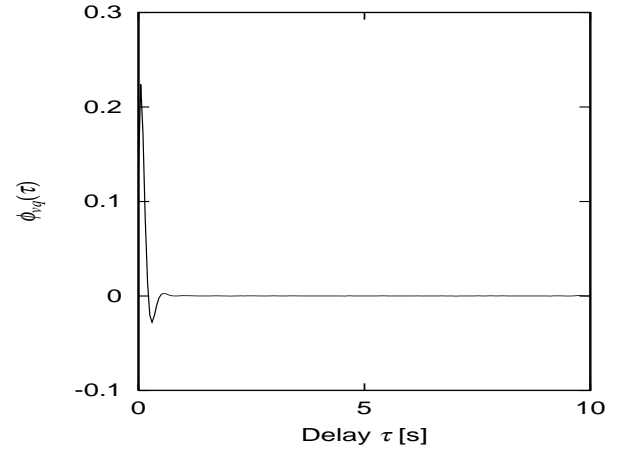

Fig. 5. Cross-correlation function  $\phi_{vq}(\tau)$  between the torque command  $v_1$  and the rotation angle  $q_1$  of the first joint in case of  $q_2 = 0$

link was fixed to 0.

From the cross-correlation function  $\phi_{vq}(\tau)$ , we obtained the first and the third order Volterra kernels of the robot manipulator. In this case, the second order Volterra kernel was very small. The first order Volterra kernels  $g_1(\tau_1)$  are shown in Fig. 6 (a) and (b), where the angle  $q_2$  of the 2nd link is equal to 0 and  $\pi/2$ , respectively. The third order Volterra kernels  $g_3(\tau_1, \tau_2, 2\Delta t)$  are also shown in Fig. 7 (a) and (b), where the angle  $q_2$  of the 2nd link is equal to 0 and  $\pi/2$ , respectively. Since the moment of the gravity changes according to the rotation angle  $q_2$  of the second link, the first and third order Volterra kernels become the function of rotation angle  $q_2$ . Comparing Fig. 7 (a) and (b), it is clear that the obtained Volterra kernels vary according to the rotation angle  $q_2$  of the second link.

## 5. Conclusion

In this paper, the authors applied the M-sequence correlation method for the identification of a robot manipulator which has two degrees of freedom. A simple model of a manipulator which consists of two links was introduced and the motion equation for the each link was derived. We made a robot manipulator which has two degrees of freedom and the proposed identification method was applied to the manipulator. From the cross-correlation function between the torque command and the rotation angle of the joint, we obtained the first and the third order Volterra kernels of the robot manipulator. We also confirmed that the obtained Volterra kernels vary according to the rotation angle of the second link.

In the experiment, the nonlinear characteristics were measured with rotating angle of the second shaft fixed. In order to apply the proposed method to MIMO system, we will identify the nonlinear characteristics of each link simultaneously. The proposed method for measuring the nonlinear characteristics of a robot manipulator would be widely applicable to actual robot systems.

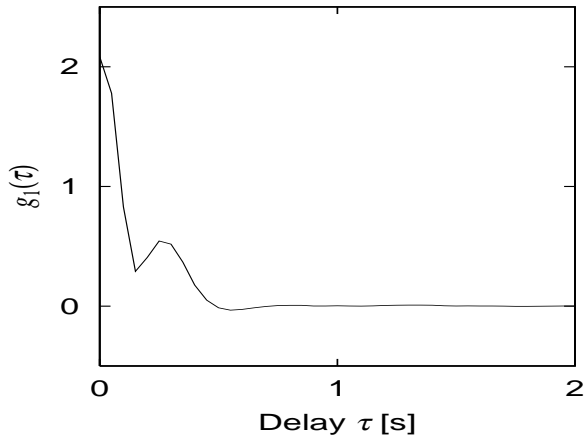

(a)  $q_2 = 0$

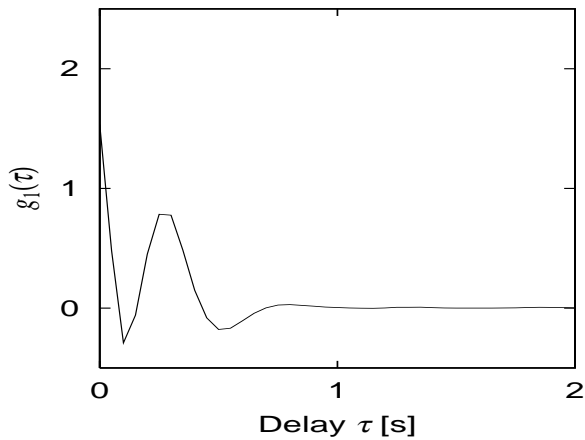

(b)  $q_2 = \pi/2$

Fig. 6. 1st order Volterra kernels  $g_1(\tau)$  obtained from cross-correlation function  $\phi_{vq}(\tau)$

### References

- [1] H.A.Barker, S.N.Obidegwo and T.Pradisthayon : Performance of antisymmetric pseudo-random signals in the measurement of second-order Volterra kernels by crosscorrelation. *Proceedings of IEE*, vol. 119, pp.353-362, 1972.
- [2] Y.Shi and K.E.Hecox : Nonlinear system identification by m-pulse sequence: Application to brainstem auditory evoked responses, *IEEE Transactions on Biomedical Engineering*, vol. 38, no.9, pp.834-845, 1991.
- [3] H.Kashiwagi and Y.P.Sun : A method for identifying Volterra kernels of nonlinear systems and its applications. *Proccesings of the first Asian Control Conference*, vol. 2, pp.401-404, 1994.
- [4] H.Kashiwagi, H.Harada and T.Yamaguchi : A Method for Measuring Nonlinear Characteristics of a Robot Manipulator, *Proceedings of IMEKO XV World Congress*, vol. X, pp.101-104, 1999.
- [5] H. Kashiwagi : *M-sequence and its application*, Shoukoudou co., 1996.

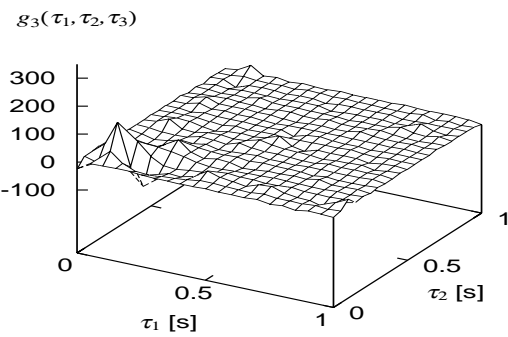

(a)  $\tau_3 = 0.1, q_2 = 0$

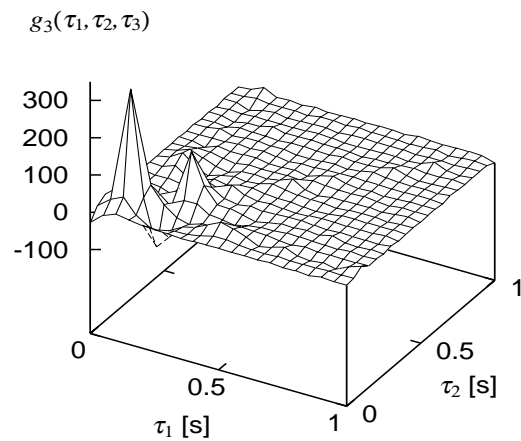

(b)  $\tau_3 = 0.1, q_2 = \pi/2$

Fig. 7. 3rd order Volterra kernels  $g_3(\tau_1, \tau_2, \tau_3)$  obtained from cross-correlation function  $\phi_{vq}(\tau)$