

Tactile Sensation Display with Electrotactile Interface

Oktay Yarimaga*, Junhun Lee*, Beom-Chan Lee*, and Jeha Ryu*

*Human-Machine-Computer Interface Lab (HuManComIn Lab)

*Department of Mechatronics, Gwangju Institute of Science and Technology, Republic of Korea
(Phone: +82-62-970-2425; Fax: +82-62-970-2384; E-mail: oktay, junhun, blee, ryu@gist.ac.kr)

Abstract: This paper presents an Electrotactile Display System (ETCS). One of the most important human sensory systems for human computer interaction is the sense of touch, which can be displayed to human through tactile output devices. To realize the sense of touch, electrotactile display produces controlled, localized touch sensation on the skin by passing small electric current. In electrotactile stimulation, the mechanoreceptors in the skin may be stimulated individually in order to display the sense of vibration, touch, itch, tingle, pressure etc. on the finger, palm, arm or any suitable location of the body by using appropriate electrodes and waveforms. We developed an ETCS and investigated effectiveness of the proposed system in terms of the perception of roughness of a surface by stimulating the palmar side of hand with different waveforms and the perception of direction and location information through forearm. Positive and negative pulse trains were tested with different current intensities and electrode switching times on the forearm or finger of the user with an electrode-embedded armband in order to investigate how subjects recognize displayed patterns and directions of stimulation.

Keywords: Electrotactile, Tactile device, Tactile sensation, Human computer interaction,

1. INTRODUCTION

Tactile sensations are necessary for many manipulation, simulation and exploration tasks such as exploring the real and virtual environment, getting surface information of objects, rehabilitation, sensory prostheses for people who are blind, tactile navigation systems and for some cases, which the system is both visually and audibly overloaded that an extra sensory aid is indispensable. They are also used in broadcasting and entertainment in order to display an object, a movement or an action in programs and games.

The glabrous skin of the body, which is richly populated with mechanoreceptors is the most common region used while exploring a surface. The activation of receptors generates the sensations what we know as vibration, pressure and any of the other feelings that we experience when we have a contact with objects around us. Four mechanoreceptors, distributed through the glabrous skin are Merkel disks (SAI), Meissner corpuscles (RAI), Ruffini endings (SAII) and Pacinian corpuscles (RAII) (Fig. 1). The mechanoreceptors have different activation frequency ranges that can be used to choose the stimulation type of interest.

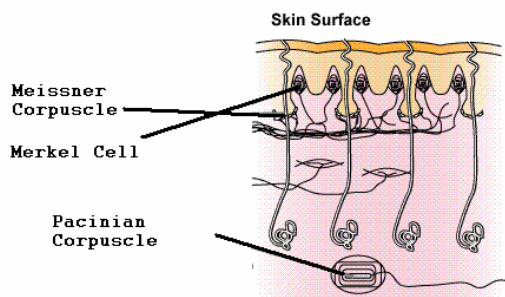

Fig.1 Mechanoreceptors in skin.

Electrotactile stimulation produces controlled, localized touch sensations at the location of a small stimulation electrode by passing a small electric current through the skin. In electrotactile stimulation, the mechanoreceptors in the skin can be stimulated individually in order to display the sense of vibration, touch, itch, tingle, pressure etc. on the body by using appropriate electrodes and waveforms in the system with-

out the need of massy components.

RAII, which was reported to give vibration and tickle sensations, has the frequency range of 40-800 Hz while RAI is responsible for touch, tickle, motion and vibration with frequency range of 10-200 Hz and finally SAI evokes edge and pressure with 0.4-100Hz.

Sensory substitution system is using one of the human senses to receive information normally received by another sense. Tactile vision substitution systems try to display the information to the skin by the same way that eye presents visual information to its retina [1]. The user studies show that vertical, horizontal and diagonal lines could be recognized by tactile displays. The effect of density and path length of the vibrotactile stimulation on directional acuity was investigated and it was concluded that it is the density, which plays the main role in the direction perception rather than the path length [2]. D. A. Eves and M. M. Novak designed a computer controlled electrotactile display system in order to assist in the interpretation of graphical data and they conducted some experiments on the fingers to evaluate users' directional acuity with the system. Angela Chang et al [3] discussed the design criteria for touch-based communication devices with identification of user needs, tactile language to be used and tried to show that without the existence of visual and audio channels, it is possible to communicate with touch communication devices, especially for the deaf-blind people. Paul Bach-y-Rita, Kurt Kaczmarek et al. have been working on tactile vision substitution system (TVSS) for blind people and experimented on fingertip, abdomen and tongue to display graphical data and images through electrotactile stimulation. They revealed the effects of waveform, location of stimulation, electrode size and other system parameters on the perception quality. Most of these studies focus on the development of tactile aid devices for visually impaired people, considering the user's needs and demands for this application.

In this paper, the waveform characteristics of electrotactile stimulation for human touch perception concept in sense of surface roughness will be considered. In a virtual environment when the user touches an object, he recognizes the object with the body location he uses through the display device. This may be done by pressing the virtual buttons in the simulation or by grasping an object. Whatever the application is, the feeling at the instant of object-user contact is defined as touch sensation.

In a virtual environment, when the user scans the surface of an object with his hand, the roughness information of the surface that is converted to tactile data may be displayed through electro-tactile system. The displayed sensation of roughness depends on system properties such as electrode type and size, the location and voltage of stimulation, contact force and the stimulation waveform, which make it necessary to examine the effects of each parameter one by one in order to obtain a full understanding of contribution of these parameters in more realistic sensations. In this paper, we will investigate the effects of stimulation waveform on displayed surface roughness with electro-tactile system, and the perception of directional information. The system, methodology and experiments after giving some information about human sensory system of touch will be explained with the results of the experiments and comments on waveform-roughness relationship and finally the future work on the current study will be stated.

2. DEVELOPMENT OF ETCS SYSTEM

The overall system block diagram is shown in Fig. 2. Power supplies, waveform generator, PC, calibration device, electrode array and the sensory interface that collects the information to be converted to tactile sensations are the main parts that will be explained in hardware and software sections in detail. The power supplies drives the constant current circuit and provides the high voltage needed to stimulate high impedance of skin. The circuit is voltage to constant current converter, which delivers the input from waveform generator as a voltage and converts that voltage to current with a constant gain [1]. The user can adjust this gain to a desired value with the calibration device. The DAQ is used to give digital signals in order to switch on/off the electrodes in the electrode array. The electrode array may be inserted to a wearable output device or a separate planar type display to be used in different applications.

2.1 Voltage to Constant Current Converter Circuits(VIC)

VIC circuit converts the voltage-based wave form to current-based wave form because human tactile sensation is basically dependent on the current which flows through human skin, not on the voltage. The voltage signal which is generated in waveform generator is usually square wave since it was shown that the most suitable and useful waveform for electro-tactile stimulation is square waveform of different parameters. Adjusting potentiometers will change the output current of VIC circuit that is the current on the electrodes. There are 32 such channels in the system, which correspond to 32 electrodes (Fig. 3). For the function of other components and detailed explanation of the circuit, one can refer to [1].

Four power supplies, +15/-15V and +120V/-120 are used to supply the power to OPAMP and to drive the high impedance

of skin, respectively. It is important to note that high voltage is hazardous to user unless all the settings are adjusted properly. High voltage power supply with dual channel of max 130V was used. This instrument includes a ground fault circuit that will shut down the supply in case of excess current in the system. Furthermore, the current output of the supply can be adjusted to a limit that will prevent the supply to deliver high current to the system. However this limit cannot be less than 50mA that is the experimented minimum current required to drive 32 channels. Since high voltage is used on the human skin, safety issue should be considered in more detail, and the details are in [1].

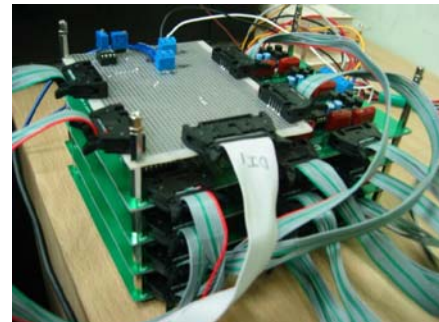

Fig. 3 32-channel VIC circuit with switching and inverter parts.

2.2 Switching and Inverter Circuit

Switching circuit is necessary to select the electrodes to activate in electrode matrix of 8x4 individually. Fig. 4 shows the circuit diagram of switching circuit for three channels with the connections to DAQ socket on PCB. It was located between the waveform generator and VIC circuit; therefore only one waveform generator input to VIC is enough for 32 channels. The switching process is succeeded by the 16 digital

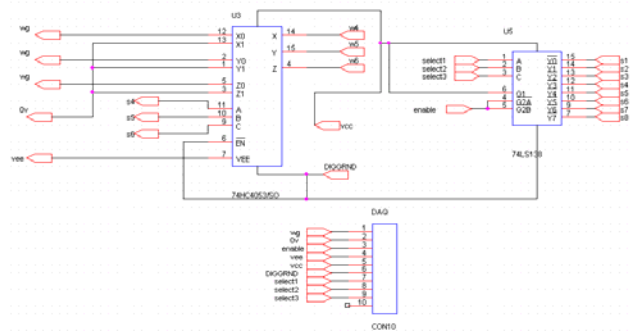

Fig. 4 Switching circuit for 3-channels and their connection to DAQ socket.

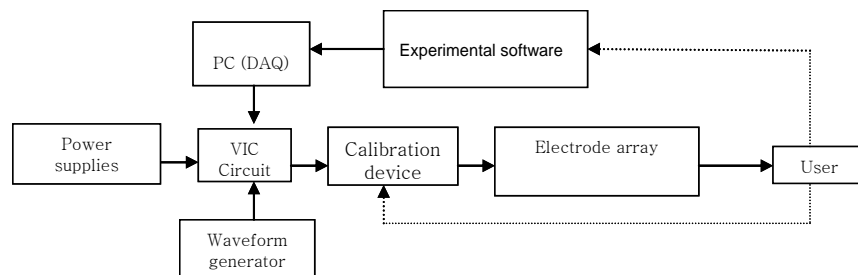

Fig. 2 System block diagram of ETCS.

output of Adlink DAQ PCI 9112. Since 16 digital outputs are not sufficient to select 32 channels individually, there is a need for digital demultiplexer as well as an analog one. 74LS138 3-Line to 8-Line decoder/demux and 74HC4053 Triple 2-channel analog multiplexer/demux are suitable for our design. The switching circuit needs two power supplies, 5/-5V. From the digital output of DAQ board it is possible to get 5V, however -5V is not available. Therefore an inverter circuit was utilized to obtain -5V in order to use for Vee of 74HC4053.

2.3 Calibration Circuit and Waveform Generator

ETCS system may be used with electrode-embedded wearable devices for different applications. One of the disadvantages of electro-tactile stimulation systems is the pain and uncomfortable feelings during the experiments. The skin condition differs for different users, therefore makes it necessary to adjust the most suitable stimulation current for the experiments for each user. There are two ways to increase and decrease the output current of the circuit. One is changing the input voltage, which is coming from the waveform generator. This computer-controlled method however cannot be used if another waveform generator with constant voltage output is utilized in the system. Furthermore, it is more convenient to let the user to adjust the proper stimulation level for him. For that reason, 32 potentiometers were used to control the VIC circuit's voltage to current gain. The user can easily control the level of current on his skin by tuning these potentiometers shown in Fig. 5.



Fig. 5 The calibration device.

2.4 Circuit-Computer Interface and Waveform Generator

The ETCS circuit is controlled through Adlink PCI-9112 DAQ digital outputs. These 16 TTL compatible outputs are used to switch on/off the 32 channels. This configuration makes ETCS easy-to-apply-to software programs, graphical applications, and etc. The card also supports 5V DC from digital output port that is used for Vcc and Vee (input to inverter circuit) for the analog and digital switches. The configuration of digital output ports is shown in Fig. 6 and its corresponding circuit parameters, in Table 1.

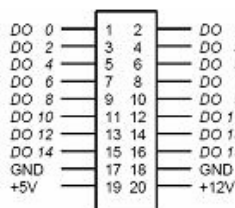

Fig. 6 Digital output configuration of Adlink DAQ.

Table 1 Digital output configuration of Adlink DAQ and corresponding circuit parameters.

Digital output channel of DAQ	Corresponding parameter of switch 74LS138
DO, D1... D11	select1, select2... select12
DO12...DO15	enable1... enable4
GND	Digital ground
+5V	Vcc

The input voltage to VIC circuit is square waveform coming from waveform generator. Velleman external PC function generator PCG10 delivers any shape of waveform within the amplitude range of 10V p-p. This range is quite enough for ETCS since 1V p-p is enough to obtain 1mA load current. Another advantage of using this device is the serial input control. Although it is not utilized in our experiments, it may provide a serial communication with PC if desired. In case of any short circuit coming from the high voltage circuit, the device has an optical isolator in order to prevent any damage.

2.4 Electrode Matrix Embedded Wearable Armband

Electrodes are embedded in an armband that is worn on the forearm. There are three main advantages of utilizing electrodes on forearm. First of all it has an extensive area to attach on a large number of electrodes easily. Secondly it is suitable for wearable electro-tactile display owing to its physical structure. Finally, it doesn't prevent other haptic devices to use in the system at the same time, especially with force feedback devices grasped with hand.

The design of armband depends on the diameter of each electrode as well as the concept of "Two-point discrimination threshold". Two-point discrimination threshold is the minimum distance that two simultaneous stimuli are distinguishable. This value was reported to be 10mm for forearm and it is smaller for sequentially activated electrodes[5]. 2mm-diameter titanium electrodes were replaced on a matrix of 8x4, with an interval of 10 mm and surrounded by an insulator gap of 4 mm around each. This has coaxial structure, which means there is an active center electrode insulated from a larger diameter dispersive electrode with air. (Fig. 7)

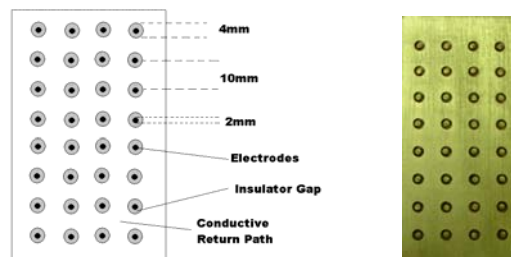

Fig. 7 Electrode-embedded armband.

The layers of armband is shown in Fig. 8. Ground layer of aluminum with 0.277mm thickness is the return path of the current coming from the electrodes. Flexible soft layer is a piece of fabric that ensures all the electrodes are in contact

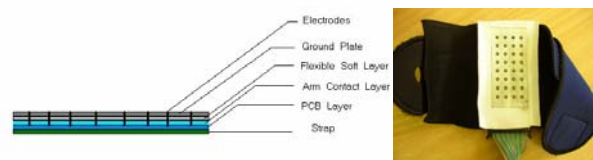

Fig. 8 The structure of armband.

with the skin when the band is worn on the arm. Its flexibility is important to behave as a spring. Arm contact layer is whiterubber with concave shape to fit the shape of the arm. The PCB layer with 1.634mm thickness is used to fix the electrodes to the band and to connect them to the constant current circuit through 34-pin block connector. The last layer is the cover of the band, which is wrapped around the arm in order to attach the device to the user. The total thickness of the band is about 1.4cm.

3. METHODOLOGY AND EXPERIMENTS

3.1 Surface Exploration and Roughness Perception

The main difficulty in texture perception experiments is the fact that even for the real objects there is no measure or exact definition of surface texture properties. This becomes more complicated when we consider the electrotactile stimulation where the displayed sensations are not same as real-life touch feelings. Therefore the measurements should be done relatively to a baseline, which is assigned an arbitrary number by the experimenter and other stimuli may then be assigned intensity numbers with respect to baseline. Before baseline assignment, the frequency range for roughness perception should be detected by experimenting with the frequency values stated in introduction part. After finding the proper frequency range and numbering the first intensity, say three, the other intensities are numbered around first one, i.e. more than three for greater roughness and less than three for smaller intensities.

The fingertips, abdomen, and tongue are the most common body locations used for electrotactile applications. In this research we wanted to investigate a different region that is suitable for wearable displays and will not prevent the utilization of other locations of hand, especially the fingers, which can be used for other haptic devices during virtual environment simulations. Therefore the stimulation location was selected to be thumb side palmar region as shown in Fig. 9.

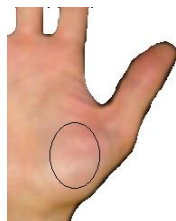

Fig. 9 The palm region used in the experiments.

Prior to each experiment, all the subjects were informed about the content and rubbed off any dust on their stimulation location with ethanol. They also scanned fabrics with textures of different roughness with their palms in order to perceive roughness information and compare the displayed sensations more accurately.

The experiments were composed of four sessions, which were conducted to measure the effect of different parameters for each one. While changing one of the waveform parameters, the others were kept constant. (Table 2).

Totally five participants were involved in the experiments and before the sessions, they were stimulated with several waveforms to get a better understanding on tactile sensations and to find the most suitable stimulation current between feeling threshold and pain threshold. The switching time for each electrode was PS/4.

Table 2 Experiment session and fixed parameter values.

Sessions	Variable Parameter	Variable Parameter Values	Fixed Parameter Values
1	F (Hz)	10, 40, 80, 100, 150, 200	PW=160, PS=4, PN=2
2	PW (μs)	80, 160, 320, 640	F=50, PS=4, PN=2
3	PS (ms)	2, 4, 6, 8	F=50, PW=160, PN=2
4	PN	1*, 2, 3, 4	F=50, PW=160, PS=4

3.2 Path recognition

In this experiment, total seven participants were involved in the experiments in order to investigate the effect of current intensity, duration-interval time of sequentially activated electrodes and polarity of the waveform on the direction and pattern perception in each session respectively. In all the experiments, four paths were displayed in random order (Fig. 10).

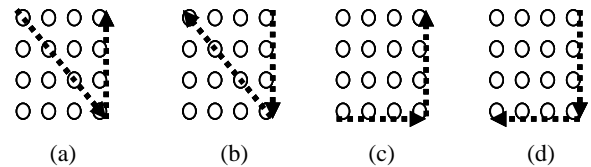

Fig. 10 Four paths.

Before the regular sessions they were stimulated several times till the subject could recognize the shapes and direction of stimulation. The subject himself using the calibration device calibrated all the electrodes slightly bigger than the threshold value, I_{th} . While collecting data, in each trial, paths were displayed not with time limit but with number of repetitions. The user should guess the pattern at most after 5 repetitions. The repetitions were made with 1~2 second intervals. In all the sessions the waveform with Frequency=50Hz; Pulse Width=320μs; Pulse Space=4ms; Pulse Number=2 was used.

In the first session, three levels of current: I_1 , I_2 , I_3 with negative pulses of the same waveform were tested. The subject was told to increase the current level of each electrode with calibration device until he feels the stimulation current. This level corresponds to I_1 , which is around the threshold current. After adjusting all the electrodes with I_1 , the level was increased by the experimenter (not by the subject) through the software till the subject feels that current clearly and comfortably. Therefore I_2 corresponds to the level between the feeling threshold and pain threshold. I_3 is the maximum current level that is close to I_p (pain threshold current) but without pain. By the same method, I_3 was found by increasing the intensity by small steps with software. During the experiments, these levels were kept constant.

There are two terms: “performance for path recognition” and “performance for only pattern recognition”. Although the results for these two performances were obtained from the same data, the patterns a, b, c and d (Fig. 10) were treated as different shapes at the performance evaluation while the pattern pairs a-b and c-d were considered same at the performance for only pattern recognition. This is true since if the direction is considered, all the patterns are different but if it is not considered the patterns a-b and c-d are same.

Second session was performed to investigate the effect of displaying speed on the performance of the subjects. Three different speeds were used by adjusting the duration and in-

terval time of the switching electrodes. These three speeds were chosen to match with very low, normal and very high speed of real air-hockey puck. If we consider the length of a standard hockey table as about 210cm and slow, normal and high speeds of the puck as 1800cm/s, 200cm/s and 20cm/s respectively. We can calculate the time duration for puck to travel between two edges of the table to be 0.117s, 1.05s, 10.5s, for three different speeds. The armband has eight electrodes to represent the length of the table therefore it makes seven electrode intervals. The traveling time of puck from one electrode to next one can be found as 0.0167s, 0.15s, 1.5s. Actually the speeds are same as the time values since the distance between the centers of two electrodes is exactly 1cm.

In third session of the experiments, changing the polarity of the waveform, the same procedure was followed with first session.

4. RESULTS

4.1 Surface exploration and roughness perception

The variable parameter vs. the average intensity of roughness with negative waveforms for each session is shown in Fig. 11. In the first session, up to F= 80 Hz, the intensity of the roughness was reported to increase. This increment is similar to scanning a real fabric with greater contact force. After F=80, the intensity is somehow constant. For the second set of experiments, the intensity increases with increasing pulse width. Actually, this is an expected result because increasing pulse width results in tougher strokes, which means higher disturbance. In Fig. 11(c), the effect of pulse space is shown. Pulse space can be treated as the grooves of a real texture in sense of disturbance frequency. Bigger the pulse space, smaller the frequency of disturbance. It is notable that there is no considerable change in intensity. The same situation exists for pulse number of the waveform (Fig. 11(d)). We can see that except PN=1, the intensities of the stimuli for PN=2,3,4 are very close to each other and resulted with higher disturbance frequency for bigger pulse number.

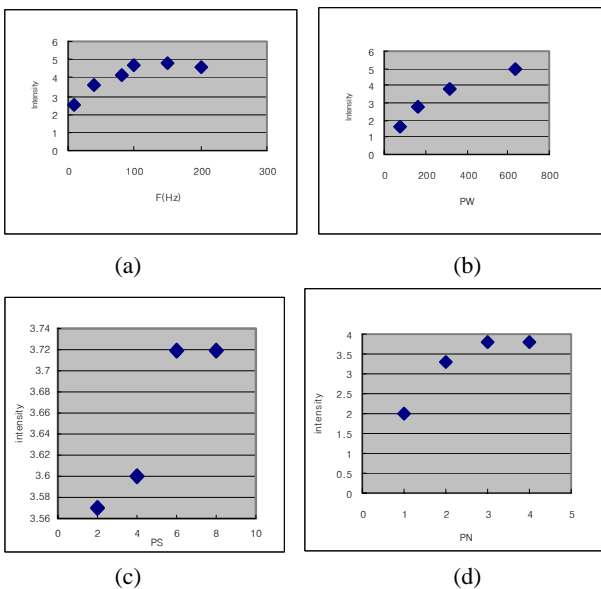

Fig. 11 (a) Frequency vs. displayed roughness, (b) PW vs. displayed roughness intensity intensity, (c) PS vs. displayed roughness intensity, and (d) Pulse number vs. displayed roughness.

4.2 Path and pattern recognition

There are some important points that were noted during the

experiments. As we mentioned earlier, a pattern was shown at most five times for one trial. However, since the performance of the subjects was very good for high current intensities (I2 and I3), most of the patterns were displayed just once.

Fig. 12 (a) and (b) show the subject performance for three current levels, I1, I2 and I3. The average accuracies for path and pattern recognition are (0.732, 0.875, 0.893) and (0.732, 0.893, 0.911) respectively. It is clear from the graphs that there is a proportional increase in the performance with current intensity. However, from I2 to I3, there is no appreciable improvement or even they are same for four subjects. This result is similar with the experiments done by Kurt Kaczmarek [4], which stated that without using very high current that is close to pain threshold (Ip), the performance of the subjects is still close to that value with lower current levels.

Fig. 13(a) through (d) show the confusion graphs for pattern pairs, a-c, a-b, b-d and c-d. These percentages show the ratio of missed pattern of interest over total display number of it in a session. The confusion of a-b or c-d means although the pattern was recognized correctly, the direction of the stimulation was missed. For a-c and b-d, the horizontal and diagonal lines were confused.

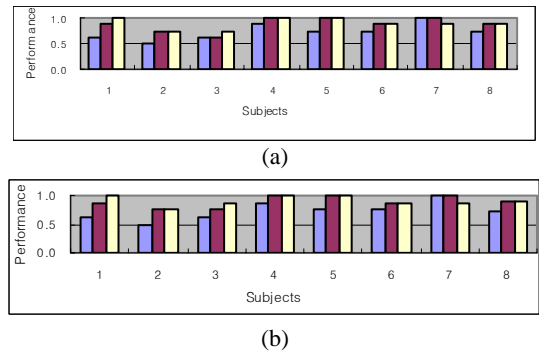

Fig. 12 (a) Subject performance for path recognition with positive pulses, (b) Pattern recognition. Three bars for each subject represent the current intensities I1, I2 and I3, respectively. The last three bars for the 8th subject are the average performances.

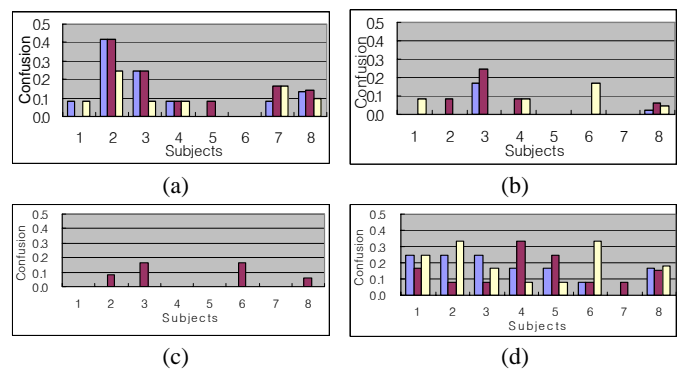

Fig. 13 (a) Ratio of confusion between a-c, (a) Ratio of confusion between a-b, (a) Ratio of confusion between b-d, (a) Ratio of confusion between c-d.

5. CONCLUSION AND FUTURE WORK

In this paper, we proposed an electro-tactile display system. In experiments, the relationship between one of the surface properties, roughness, and the stimulation waveform parameters of electro-tactile display was investigated. While frequency

and pulse width play an important role on the intensity, frequency, pulse space and pulse number were shown to affect the intensity of the disturbance. As a second study positive and negative pulse trains were tested with different current intensities and electrode switching times on the forearm of the user with an electrode-embedded armband in order to investigate the performance of the subjects to recognize the shape of the displayed patterns and direction of stimulation. Current level between two thresholds (I_s and I_p) provides satisfying performance without a need for very high current levels. Three different stimulation speeds were tested for slow, normal and fast modes, which correspond to very slow, normal and maximum speed of real air-hockey puck. For slow and normal mode, the average accuracy of direction and pattern recognition was close to 0.9 and even for very fast stimulation, it may reach up to 0.46 by adequate training in advance.[13] Proper stimulus sequence will improve user's feeling of continuous movements of the object.

Our future goal is to use this information to model the surface of the virtual objects in a virtual environment. This will help the user to interact with the virtual world by touching and scanning the objects not only through the haptic devices with force feedback but also with electrotactile displays. The present system is bulky because of the power supply, and 32 VIC circuits. Just four VIC circuits may be good enough by demultiplexing the signal instead of 32 VIC circuits. In addition, 14.8V to $\pm 120V$ step up power supply should be good to make the system portable as well as wearable. Also an effort to make the feeling more comfortable is needed. Before the calibration device is adjusted properly, users get some painful feeling. To adapt this system to wider application, this problem needs to be solved.

ACKNOWLEDGMENTS

This research was supported by the Ministry of Information and Communication through the smart haptic interface project.

REFERENCES

[1] K. A. Kaczmarek and K. M. Kramer, "A 16-Channel 8-Parameter Waveform Electrotactile Stimulation System", *IEEE Transactions on Biomedical Engineering*, Vol.38, No.10, 1991.

[2] C. J. Poletto and C. L. Van Doren, "A High Voltage, Constant Current Stimulator for Electrocutaneous Stimulation through Small Electrodes", *IEEE Transactions on Biomedical Engineering*, Vol.46, No.8, 1999.

[3] J.A. De Lima and A.S. Cordeiro, "A Simple Constant Current Neural Stimulator with Accurate Pulse-Amplitude Control", *Proc. of the 23rd Annual EMBS International Conference*, 2001.

[4] T. Keller, M. R. Popovic, P. I. Pappas, and Pierre-Yves Muller. "Transcutaneous Functional Electrical Stimulator: Complex Motion", *7th Vienna International Workshop on Functional Electrical Stimulation*, 2001.

[5] K. A. Kaczmarek, J. G. Webster, P. Bach-y-Rita, and W. J. Tompkins, "Electrotactile and Vibrotactile Displays for Sensory Substitution Systems", *IEEE Transactions on Biomedical Engineering*, Vol. 38, No. 1, 1991.

[6] K. Kaczmarek and S. J. Haase, "Pattern Identification as a Function of Stimulation Current on a Fingertip-scanned Electrotactile Display", *IEEE Transactions on Neural Systems and Rehabilitation Engineering*, Vol.11, No.3, 2003.

[7] H. Kajimoto, N. Kawakami, T. Maeda, and S. Tachi, "Electrocutaneous Display as an Interface to a Virtual Tactile World", *Proc. of IEEE-VR*, pp.289-290, 2001.

[8] H. Kajimoto, M. Inami, N. Kawakami, and S. Tachi, "SmartTouch - Augmentation of Skin Sensation with Electrocutaneous Display", *Proc. of the 11th Symposium on Haptic Interfaces for Virtual Environment and Teleoperator Systems*, pp.40-46, 2003.

[9] S.J. Lederman, "Tactile roughness of grooved surface s: The touching process and effects of macro- and microsurface structure", *Perception & Psychophysics*, Vol. 16, pp. 385-395, 1974.

[10] S. J. Lederman and M. M. Taylor, "Fingertip force, s urface geometry and the perception of roughness by active touch" *Perception & Psychophysics*, Vol. 12, 4 01-408, 1972.

[11] P. Penn, H. Petrie, C. Colwell, and D. Kornbrot, "Th e perception of texture, object size and angularity b y touch in virtual environments with two haptic devic es", *Proc. First Int. Workshop on Haptic Human Computer Interaction*, pp. 92-97, 2000.

[12] H. Kajimoto, N. Kawakami, T. Maeda, and S. Tachi, "Electro-Tactile Display with Force Feedback", *Proc. of World Multiconference on Systemics, Cybernetics and Informatics*, Vol.X1, pp. 95-99, 2001.

[13] Oktay Yarimaga, Beom-Chan Lee, Jeha Ryu, and Nitaigour Premchand Mahalik "An Electrotactile Device for Broadcasting and game applications", *HCI2005 Korea*, Vol 1, pp 388-394