

**Design and Control of a Six-degree of Freedom
Autonomous Underwater Robot “CHALAWAN”**

T. Chatchanayuenyong* and M. Parnichkun**

* School of Advanced Technologies, Asian Institute of Technology,
P.O.Box 4, Klong Luang, Pathumthani, 12120, Thailand
Fax: +66-2524-5697 E-mail: st029179@ait.ac.th

**School of Advanced Technologies, Asian Institute of Technology,
P.O.Box 4, Klong Luang, Pathumthani, 12120, Thailand
Fax: +66-2524-5697 E-mail: manukid@ait.ac.th

Abstract: Water covers two-thirds of the earth and has a great influence on the future existence of all human being. Thailand has extensive coastline and near shore water that contain vast biological and mineralogical resources. The rivers and canals can be found around the country especially in the Bangkok, which once called the Venice of the East. Autonomous underwater robot (AUR) will be soon a tool to help us better understand water resources and other environmental issues. This paper presents the design and basic control of a six-degree of freedom AUR “Chalawan”, which was constructed to be used as a testbed for shallow. It is a simple low cost open-frame design, which can be modified easily to supports various research areas in the underwater environment. It was tested with a conventional proportional-integral-derivative (PID) controller. After fine-tuning of the controller gains, the results showed the controller’s good performances. In the future, the dynamic model of the robot will be analyzed and identified. The advanced control algorithm will be implemented based on the obtained model.

Key words: Autonomous underwater robot, Autonomous underwater vehicle, PID control, Heading control

1. Introduction

Most commercial unmanned underwater robots are tethered and remotely operated, referred to as remotely operated vehicles (ROVs). Extensive use of manned submersibles and ROVs are currently limited to a few applications because of very high operational costs, operator fatigue, and safety issues. As the result, AUR has become an important tool for underwater operations. AUR becomes more and more useful in various kinds of operation such as underwater research, shallow water and deep water diver support, underwater inspection of pipes and structures, underwater survey, etc. Many autonomous underwater robots (AURs) have been built by research institutions around the world to serve various purposes such as the KAMBARA [1], OTTER [2], ORCA [3], ODIN [4], all of them are used as research testbeds. This paper discusses design and development of an autonomous underwater robot testbed named CHALAWAN (CHALAWAN is a crocodile in Thai legend that can turn into a human being at its golden cave). It is an open-frame underwater robot equipped with various sensors. It is designed and developed as a modular platform to support a variety of researches especially in the autonomous technologies.

2. Design Philosophy and Principle

The underwater robot is mainly designed to be used as a testbed for shallow water research. The robot is a simple low cost open-frame design, which can be modified easily to supports various research areas in the underwater environment. The hardware and software are designed to create a flexible framework upon which individual researcher can integrate, develop and test new technologies in a single robotic system in the future. The robot is neither designed nor constructed for operations in the harsh environment. Hence, without the constraint of hardware durability or the hazardous-withstanding material, prototype of the robot subsystems is constructed to test in the research environment. The robot maneuver is designed to enable the robot to operate in six-degree of freedom: roll, pitch, yaw, surge, sway and heave.

3. Mechanical System

3.1 Farings

Hull of the AUR consists of two dry compartments. The compartments are made of six-inch PVC pipe, with 72 cm long each. The pipes are mounted on aluminum frame vertically. Two gasketed aluminum plates are bolted to the both ends of each pipe. All electrical connections are done through IP68 submersible plugs (Fig. 1). The upper compartment contains processor, vertical gyroscope, compass, and pressure sensor (Fig. 2). The bottom compartment contains power electronics driving the thrusters (Fig. 3). Battery packs are installed in the lowest part. This arrangement is designed to make the batteries as low as possible to lower metacentric height and increase the righting moment of the vehicle. As the result, the robot is stable in pitch and roll directions. All electronic equipments are installed on slide-out acrylic boards. Each compartment is pressurized to 3 PSIG during operation to reduce the risk of water leaking into the hull and aid in leak detection.

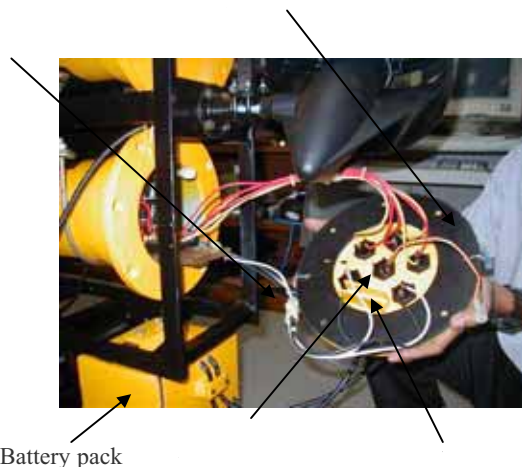

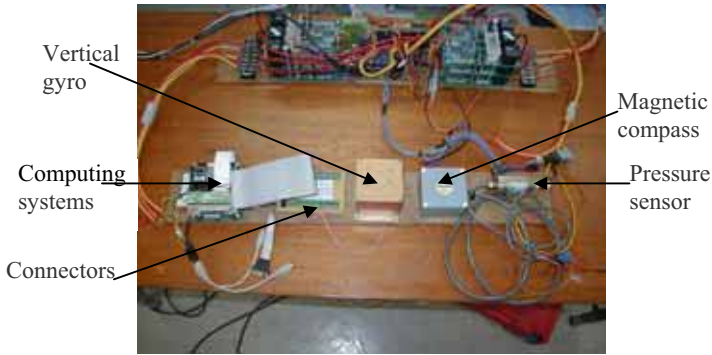

Fig. 2 Equipment Installation in Upper Compartment.

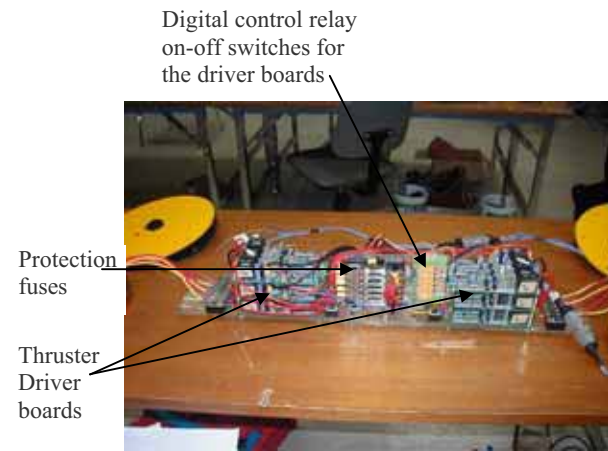

Fig. 3 Equipment Installation in Lower Compartment.

3.2 Thrusters

The AUR is equipped with six thrusters, which are modified from the Minnkota Classic 28, 12 V electric trolling motors with 9" diameter propellers. These motors provide approximately 28 pounds of thrust, and are fitted with o-ring seals. Each propeller is shrouded to prevent incidental blade contact (Fig. 4).

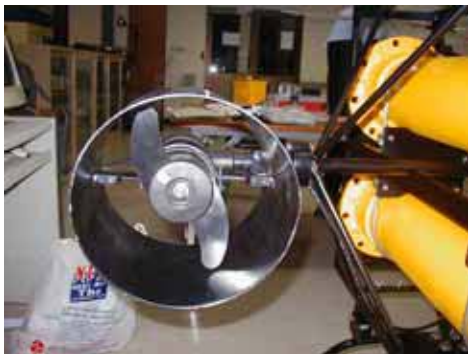

Fig. 4 The Robot Thruster Which is Modified from a Trolling Motor.

By the thrusters configuration, the robot can operate in six-degree of freedom (Fig. 5).

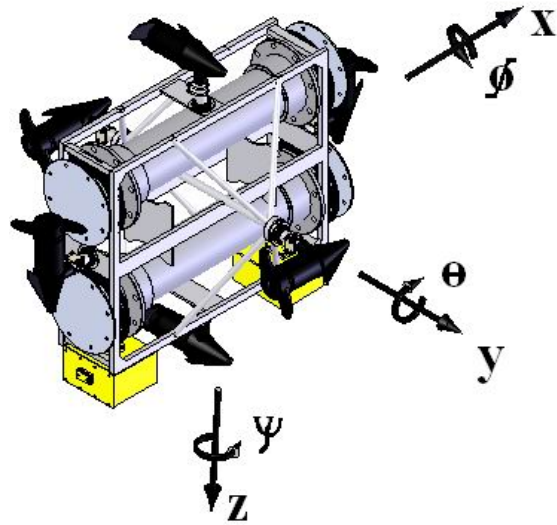

Fig. 5 CHALAWAN's Coordinate, Position (X, Y, Z) and Orientation (ψ , θ , ϕ), System.

Fig. 6 depicts typical thruster static model obtained from the experiments.

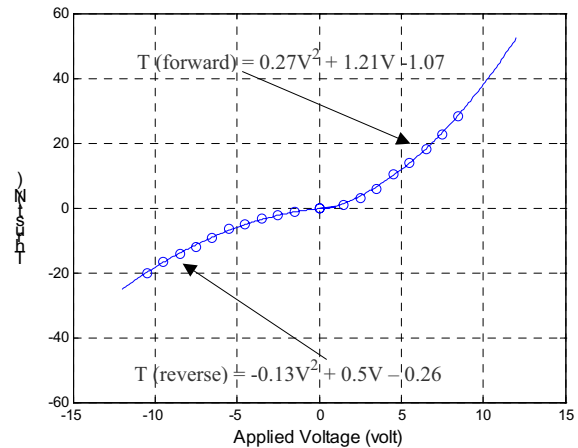

Fig. 6 Typical thruster static model.

The graph shows the relation between thruster force and applied voltage at steady state. The thrusters are highly asymmetric in forward and reverse directions. Two models are obtained. They are used in the robot control to map commanded thrusts to applied voltage.

3.3 Motor Driver Boards

To drive the motors, MCIPC-12 motor driver boards from Diverse Electronics Services are used. The units generate PWM output to vary speed of the motors continuously from stop to full forward and stop to full reverse. These units are 30 amps rated at 12 V. The processor generates a command via D/A board sent to the driver boards to control the motor speed and direction.

4. Sensor System

4.1 Inertial Measurement Unit

A solid-state vertical gyro VG400cc-200 from Crossbow Technology, inc. is used to provide roll/pitch angles, roll/pitch/yaw angular rates and three-axis linear accelerations. This unit provides both digital and analog signals. The roll and pitch angles measured with a range of ± 180 and ± 90 degrees respectively from horizontal and a resolution of 0.1 degree. The roll/pitch/yaw angular rates are measured with a range of ± 200 degree/sec and a resolution of 0.05 degree/sec. The three-axis accelerations are measured with a range of $\pm 10g$ and a resolution of 1.25 mg. All measurements are updated continuously at 75 Hz.

4.2 Compass Module

A KVH C100 compass from KVH-Industries is used to provide measurement of yaw angle (heading). The compass has an accuracy of ± 0.5 degree and a resolution of 0.1 degree. The heading is calculated internally at 10 Hz and can be provided in both digital and analog forms.

4.3 Depth Sensor

The AUR's depth can be inferred from hydrostatic pressure measurements from a pressure transducer. The measured pressure is directly proportional to the depth (h) below the surface as shown in Eq. (1).

$$P_A = P_0 + \rho gh \quad (1)$$

Where P_A is the absolute pressure.
 P_0 is the pressure on the surface of the water. ($P_0 = 101,325$ Pascal)
 ρ is water density in kg/m^3 . ($\rho = 1,000$ kg/m^3 for fresh water)
 g is gravitational acceleration in m/s^2 . ($g = 9.806$ m/s^2)
 h is depth from water surface in meter.

PX203-050A10V, a general purpose 1-11 V analog output pressure sensor from Omega Engineering, inc. is used to provide the absolute pressure measurement (Fig. 7). The unit has a range of 50 PSI absolute pressure and an accuracy of 0.25% FS. At this accuracy, the depth can be measured at a resolution of 8.8 cm.

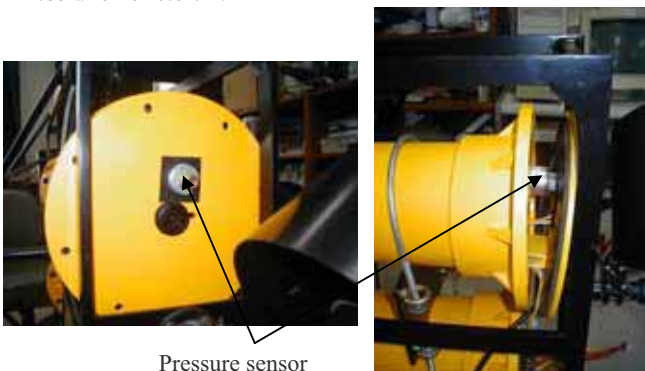

Fig. 7 Pressure Sensor Installation.

4.4 Sonar Altimeter

The height from the water bottom is measured using a low cost wide beam underwater ultrasonic transceiver,

HE123TR from Hexamite. The unit has a range of 0.1 m-25 m for the echo operation. It transmits 155 dB $\pm 35^\circ$ wide beam signal at 23.5 kHz

5. Computing System

The AUR is intended to be a testbed for advanced control implementation. And as its so-called name, an autonomous underwater robot, its primary control computing will be carried onboard.

5.1 Main Processor

The main processor has to provide adequate processing capacity for simultaneous filtering, sensor data acquisition and servo control. Moreover, the computing system and card cage has to be small enough to fit within the upper cylinder hull, 15.5 cm diameter and 72 cm length. A standard PC/104 processor module with the size of 96 mm x 90 mm is selected. A PCM-3350 300 MHz CPU module, 128 MB SDRAM system memory, 128 MB hard disk, 2 serial ports, 1 parallel port from Advantech is chosen to serve the purpose.

5.2 Analog to Digital Converter Board

At least 16 A/D channels are required at 12 bits resolution for vertical gyro (8 chs), compass (1 ch), pressure sensor (1 ch), sonar altimeter (1 ch), battery voltage (1 ch) and the other 4 spare channels for future extension. A PCM-3718HG from Advantech, which has 16 single-ended inputs, 12 bits resolution, 100 kS/s is used to serve the purposes.

5.3 Digital to Analog Converter Board

Six brushed DC motors are used for the robot thrusters. These motors are driven by six motor driver boards, which generate PWM signals to control the motor speed and direction. The motor driver boards are commanded by the analog signals, thus, at least 6 D/A channels are required. A RMM-8XT, 12 bits, 8 D/A channels from Diamond Systems Corporation is used to serve the purposes.

6. Power Supply

The AUR carries two water-proof battery boxes on-board, each contains two 12 V 12 Ah sealed lead-acid batteries providing 576 watt hours supply power for the thrusters, the electronic and sensor systems (Fig. 8). Every electrical circuit is protected by its own fuse. The power from batteries is switched on-off via a set of relays through digital I/O. By this configuration, when the main processor is shut off, the batteries are disconnected from load automatically.

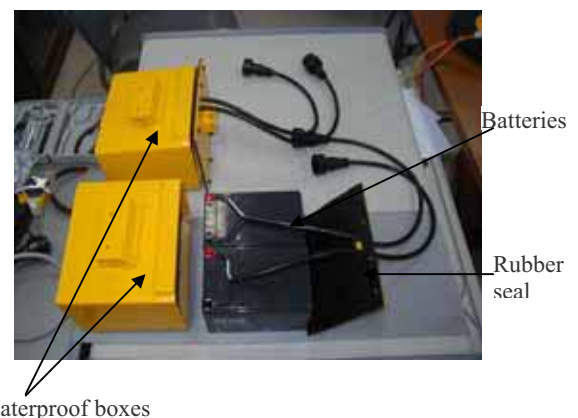

Fig. 8 Battery Packs Installed in the Waterproof Boxes.

The overall schematic diagram of the robot's power distribution is shown in Fig. 9.

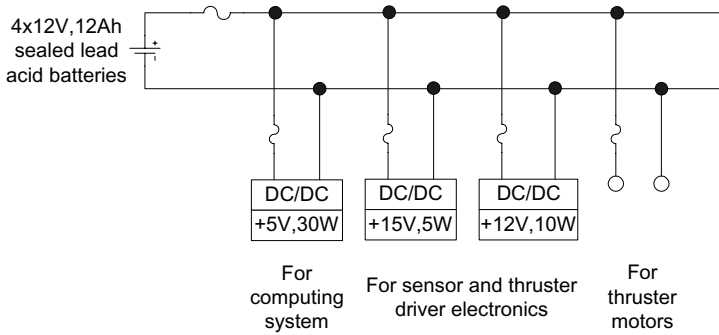

Fig. 9 Overall Power Distribution Schematic Diagram.



Fig. 10 Overall Robot Assembling.

7. The Overall System Configuration of the Robot

Fig. 10 and Fig. 11 show the complete robot assembling and the overall system configuration of the robot respectively.

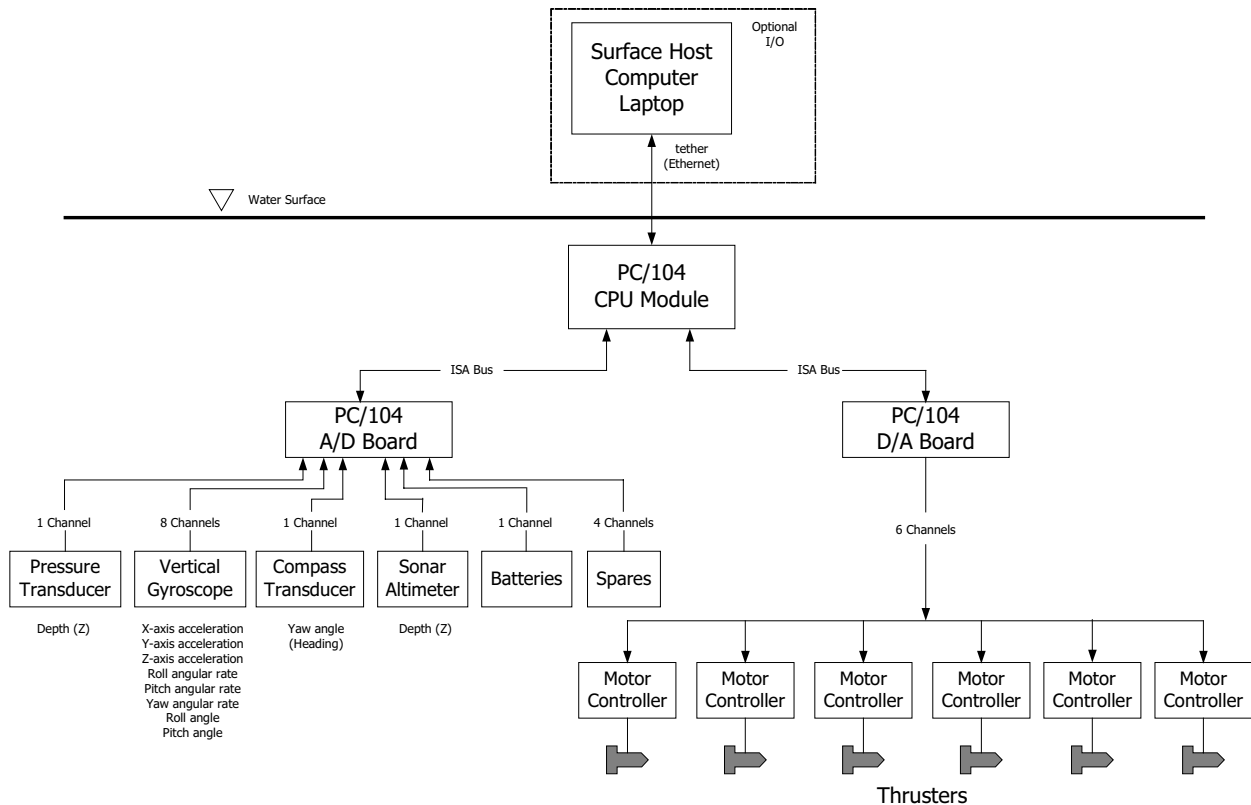

Fig. 11 Overall System Configuration of the Autonomous Underwater Robot

8. Software Architecture

The software architecture is designed to serve the objective of the testbed that is to implement the advanced control for the autonomous underwater robot. It is flexible and easy to modify. To meet this objective, the software architecture is separated into modules; sensor sampling module, robot control module and thruster control module. The control of the robot is real time by its nature. Real-time program differs from the conventional program that the sequence of its actions is not determined by the designer but triggered by the real time events occurring in the outside world. The robot control software is designed to suit the real-time control scheme. A clock-driven task real-time system is used in the robot software architecture. The signal from real-time clock of A/D card is employed to interrupt the operation of the CPU and carry out data transfer at a specified time interval. This operation is run in background while the other robot data acquisition and control operation is run in foreground.

The overall software architecture is shown in Fig. 12.

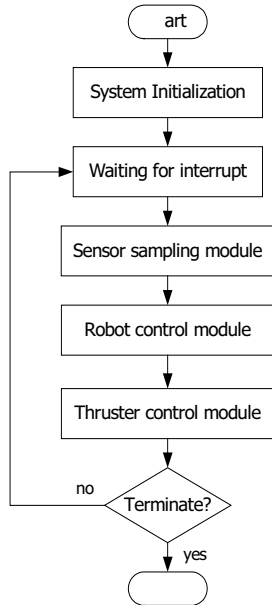

Fig. 12 Overall Software Architecture.

9. Robot Feedback Control System

To test the working performance of the constructed robot, the classical proportional-integral-derivative (PID) feedback controller is used to control the heading of the robot. Figure 13 shows the robot feedback control block diagram that is implemented on the robot.

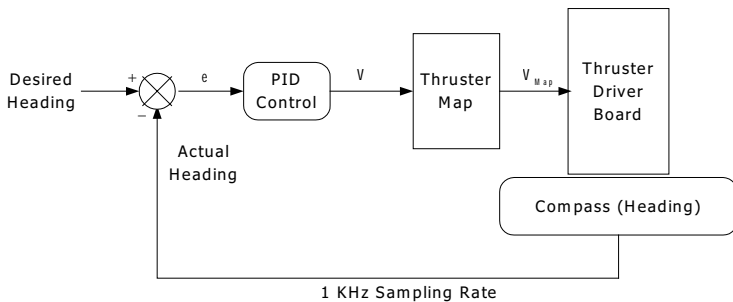

Fig. 13 PID Feedback Control Block Diagram.

The control loop is implemented digitally with a 1 KHz update rate.

A continuous PID control law, which transfer function is

$$G(s) = \frac{u(s)}{e(s)} = K_P \left(1 + \frac{1}{T_I s} + T_D s \right) \quad (2)$$

where K_P is the proportional gain.
 T_I is the integral time.
 T_D is the derivative time.
 $u(s)$ is the controller output.
 $e(s)$ is the error, which calculated from the difference between the actual and desired heading angle.

, is implemented digitally by using equation (3) below.

$$u(k) = u(k-1) + K_P \left[\left(1 + \frac{T}{T_I} + \frac{T_D}{T} \right) e(k) - \left(1 + 2 \frac{T_D}{T} \right) e(k-1) + \frac{T_D}{T} e(k-2) \right] \quad (3)$$

All of the PID parameters are primarily set by Ziegler and Nichols tuning rule and then fine-tuned to obtain the satisfactory responses. The parameters are given in Table 1.

Table 1 PID Parameters

Controller Type	K_P	T_I	T_D
P	0.15	inf	0
PI	0.3375	6.4167	0
PID	0.45	3.25	0.0125

The experimental results are shown in Fig. 14~16.

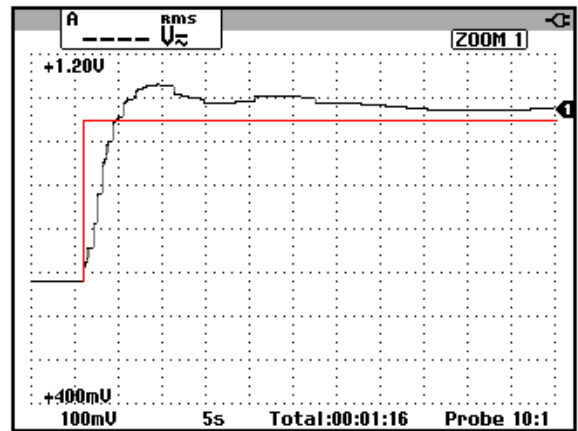

Fig. 14 Proportional (P) Control Experimental Result.

12. References

- [1] Robotics Systems Laboratory, Australian National University Homepage. <http://www.syseng.anu.edu.au/rsl/sub/>
- [2] Stanford University Aerospace Robotics Laboratory Homepage. http://arl.stanford.edu/projects/underwater_robots/
- [3] MIT Project O.R.C.A. Homepage. <http://web.mit.edu/orca/www/index.shtml>
- [4] Autonomous System Laboratory Homepage. <http://www.eng.hawaii.edu/%7Easl/>
- [5] D.Richard Blidberg. "The Development of Autonomous Underwater Vehicles (AUV): a Brief Summary". *AUSI, ICRA, Seoul, Korea*, May, 2001.
- [6] J.Yuh. "Design and Control of Autonomous Underwater Robots: A Survey". *2000 Kluwer Academic Publishers, Autonomous Robots*, Vol.8, pp. 7-24, 2000.
- [7] C.Silpa-Anan. "Autonomous Underwater Robot: Vision and Control". *Thesis Report for the Degree of Master of Engineering at The Australian National University*, pp. 51-73, February 2001.
- [8] H. H. Wang, S. M. Rock and M. J. Lee. "OTTER: The Design and Development of an Intelligent Underwater Robot" *1996 Kluwer Academic Publishers, Autonomous Robots*, Vol.3, pp. 297-320, 1996.

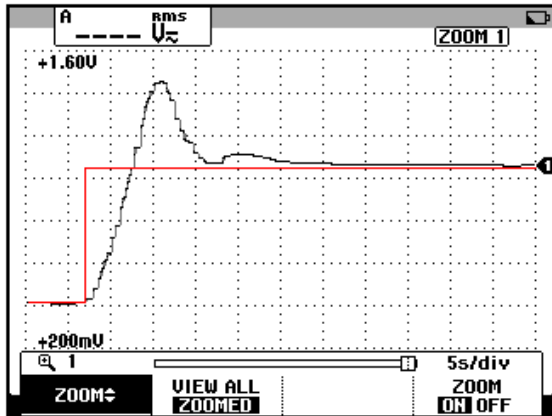

Fig. 15 Proportional Plus Integral (PI) Control experimental result.

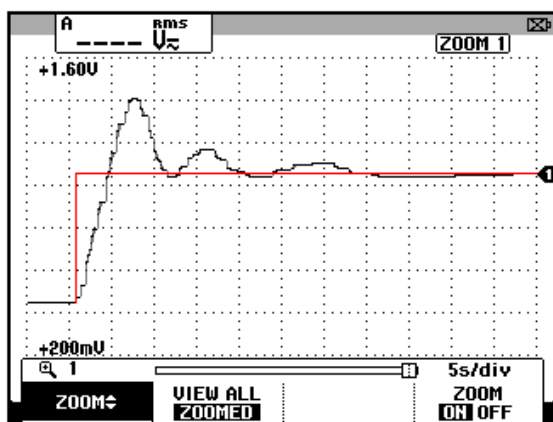

Fig. 16 Proportional Plus Integral Plus Derivative (PID) Control experimental result.

From the above results, the good positioning performances are achieved by using each control strategy. In addition, it is noticed that, for P control, there is offset error at the steady state, while for PI and PID controls, the offset is minimized as well as the improvement of the system dynamic response.

10. Conclusion

The autonomous underwater robot "CHALAWAN" has completely been built. It is an open-frame robot equipped with various sensors, which shall be used as a research testbed for the autonomous technologies in underwater environment. It is also used to test new, innovative actuators and sensors. The classical proportional-integral-derivative (PID) controller was successfully employed to test the robot's working performance. The other advanced low-level control algorithm and high-level strategies will be developed on the testbed in the future.

11. Acknowledgments

This project is financially supported by the Royal Thai Government.