

Development of the Dynamometer Control System for Medium Speed Diesel Engines

Sang-Gu Choi*, Sang-Hun Ryu*, Jeom-Goo Kim* and Ho-Chol Park**

* Automation Research Department, Hyundai Heavy Industrial Research Institute, Ulsna, Korea
(Tel : +82-52-230-3208; E-mail: bestnine@hanafos.co.kr)

** Medium Speed Engine Assembly & Test Department, Hyundai Heavy Industrial , Ulsan, Korea
(Tel : +82-52-230-3214; E-mail: choisgu@daum.net)

Abstract :

The dynamometers which had made in a long time ago could not control the input/output quantity of water minutely and was sensitive to a noise since it was controlled by an analog control method. Therefore, a fully digital controlled system was urgently required to be robust against various noises. In this paper, the new system which can control the amount of circulated water in dynamometer was developed. This system is consisted of an industrial digital type controller and a servo motor. The industrial PLC was used as a main controller for the developed system, and the actuator and servo motor were used to control the inlet and outlet valve independently. The torque signal of load cell was fed back to the main controller to regulate the diesel engines load. Generally, an input/output valve position of the old dynamometer was fixed with a proper situation for an engine output test and the torque was changed according to the time interval. However, the torque value for the dynamometer could not be constantly kept because of the variation of the input water flow and fluid characteristic. Therefore, the automatic control of an inlet and outlet valve should be performed to keep the constant torque. So, the PID control method was applied to solve this problem. Also, the development of a web-based remote control system was described in this paper. This software will give us the convenience of operation, the more efficient operations, and the reduced operator workload for operation of the dynamometer. The application results of the system have been verified at actual diesel engine field.

Keywords: Medium Diesel Engines, Dynamometer, PID Control, Web Based Remote Control

1. INTRODUCTION

Currently, a diesel engine is almost used for the driving force in ships because of the economy of fuel, the thermal efficiency, and the convenience of treatment. The engine performance test must be carried out to investigate whether the manufactured diesel engine can output enough design power. Dynamometers are usually used to a performance test of an engine. Dynamometers are devices absorbing the power of prime engine and measuring the absorbed torque. Particularly, hydraulic dynamometers absorb the power of engine which is transmitted to the break shaft by the hydraulic resistance between the rotor, the stator and housing. The turbulent friction of cooling water in the break converts mechanical energy into heat energy. So cooling water by temperature rise goes through the break system. On the processing of this conversion, a torque indicator shows a turning torque of the break shaft and can estimate the absorbing power of the break. So, dynamometers of a water break type are used for a performance test of diesel engines.

The engine performance data in operation is important in engine manufacturing process. The data can be used for deciding the performance of an engine and also useful as business information for ships. For a long time, dynamometers have been used as a proper device for testing of engines under speed and torque transients, owing to their torque absorption capacity per unit rotational inertia. Therefore, the precision of dynamometers in the control system has gradually been required for a correct test of engines performance. Therefore, it is an important to control the inflow/outflow rate of water by the water control valve installed in dynamometer system.

In this paper, the new system should have an industrial digital type controller and a servo motor which can control the amount of water. The industrial PLC was used as a main controller of the developed system, and the actuator and sever motor were used for control of the input and output part valve independently. However, the torque value for the

dynamometer could not be constantly kept because of the variation of the input water flow and fluid characteristic. Therefore, the auto adjusting an input/output valve should need to keep the constant torque. Also, this paper described the development of a web-based remote control system by an internet socket program that allows the implementation of such a system.

2. THE SYSTEM OF DYNAMOMETER

2.1 Manufacture of Water Break Type

A water break is a dynamometer which uses momentum exchanger or turbulence between rotor and stator to provide the load torque. The working fluid, usually water, is circulated through the machine removing the heat equivalent of the absorbed power. Several design variations are commonly used.

Figure 1. is the internal structure of the dynamometer which was newly made for this paper. Now, this is used for the performance test of a HIMSEN engine of our company.

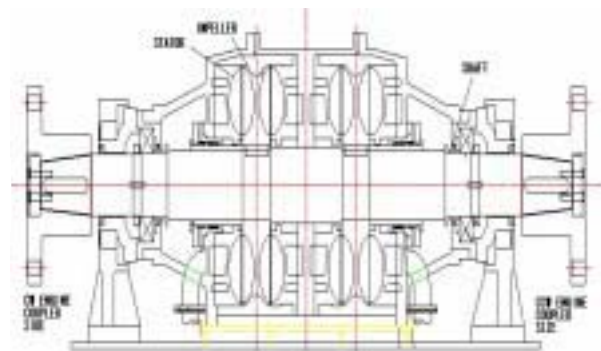

Figure 1. The structure of dynamometer

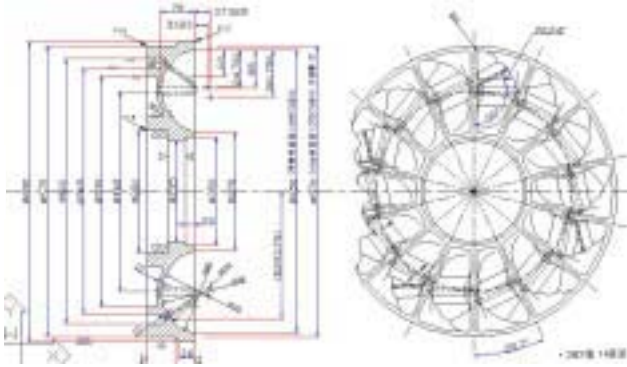

Figure 2. The Design of Stator

The inner water of a dynamometer plays breaking and cooling. Specially, this system is high precision and stable when we test the performance of engine which has high speed and power. While a dynamometer turns with engine, the amount of water, temperature and pressure have an effect on the torque change. And the pressure of water which supplied to this system is 1~ 1.5 kg/cm. The torque is controlled by the valve adjustment of inlet and outlet position in this system. The equations which were used to engine performance calculation is as follows.

$$T = W \times L \quad (1)$$

$$P = \frac{2\pi \times W \times L \times N}{60 \times 75} = \frac{2\pi \times T \times N}{60 \times 75} \quad (2)$$

- T : Break Torque(kg-m)
- P : Break Horse Power(ps)
- W : Break Weight(kg)
- L : Arm Length of Dynamometer(m)
- N : Speed (rpm)

2.2 The Control System

2.2.1 The design of control system

Fig. 3 is shown the configuration of control system of dynamometer. The main controller is PLC(Programmable Logic Controller) which is applied to the most industrial field. We used a touch screen for users interface with program. The remote control that is based the internet is possible.

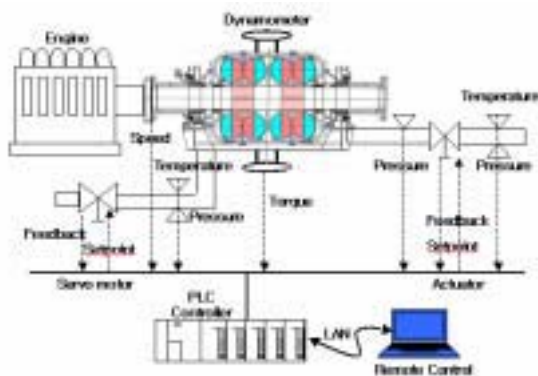

Figure 3. The configuration of system

The control system can currently take status by all kinds of installed sensors in the dynamometer. The temperature sensors installed in inlet and outlet are to measure water temperature to passed through dynamometer. A regular temperature must be kept because a water temperature has effect on performance of dynamometer. Also, The pressure sensors installed in the Inlet valve to measure the supplied pressure to dynamometer. And a pressure sensor installed in an outlet valve to measure the inner pressure of dynamometer. The torque is measured with strain gage load cell. Strain gage load cells are available in various configurations. The advantages of the strain gage load cell systems are their compactness, low error, and provision for auxiliary instrumentation and control from the electrical output signal. The disadvantages are the effects from stray vibrations produced by other operating equipment, the limited fatigue life of the gage bonding, and the need for temperature compensation. The electrical signal of a road cell passes through a signal converter, and is input to A/D module of PLC. The engine power calculates with formula (1),(2). The following fig. 4 is shown a running dynamometer with medium speed engine and control panel. A table 1 is a detail explanation of controller components.



Figure 4. The developed dynamometer and control panel

Table 1. The specification of control system

Components	Specification
Controller(Mitsubishi)	- PLC - Analog Input Unit : 4CH - Analog Output Unit : 2CH - Servo Position Unit : 2CH - High Speed Counter : 1CH - Pt100Ω Input Unit : 4CH
GUI(Mitsubishi)	Touch Screen(GOT900)
The Valve Control	- Inlet : Actuator(Tomoe) - Outlet : Servo Motor 1KW(Mitsubishi) Reduction rate 6:1
Speed	- Magnetic Pick-Up Sensor (0~20,000Hz)
Torque	- Load Cell(3mV/V)

As for the dynamometer system, it is mostly important that it adjusts amount of water for a toque change. Therefore, We installed a valve to the inlet and outlet of dynamometer in order to control a amount of water circulated through in system. We applied electric actuator for inlet valve control in this system. The position of a outlet valve is controlled by a servo motor. The electric actuator which a position control

board was built in practices the position control. An electric current signal for a set-point value input to the position control board, and composes a feedback circuit. The inlet valve wasn't opened over 60% for safety and was limited by programming of the PLC. The outlet valve which is controlled with a servo motor is operated with pulse signal which is appeared by PID controller. This pulse signal give to the servo driver and encoder signal is fed backed to it. So, The output valve set up the limit which don't close below 10%. The following figure 3,4 showed the schemes of inlet/outlet valve control.

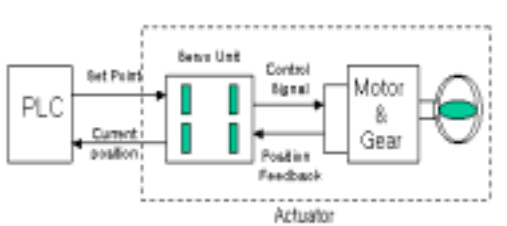

Figure 5. The configuration of inlet valve control

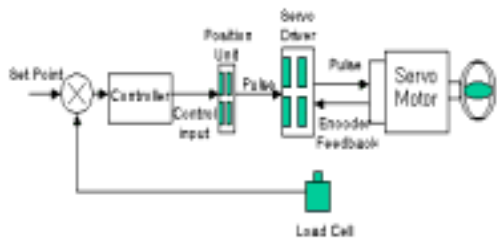

Figure 6. The configuration of outlet valve control

2.2.2 The experiment of the load control in Engine

Generally, In the company which manufactures an engine, the dynamometer power is changed in given time interval during the performance test of engines. So, dynamometer is regularly kept to the torque in the steps of engine outputs. But, if a valve position is fixed, the torque of dynamometer is oscillated to the target point because of variations of amount of water and pressure. Therefore, we need a feedback controller which is automatically kept to target point. In this system, we implemented PID algorithm using PLC functions.

So, we controlled to the outlet position valve with load cell signal because this algorithm is suitable SISO(single input single output)system.

A) Implementation of PID Controller

The inlet valve is controlled to maintain a certain position by position control unit in the actuator according to the engine output power. The outlet valve is feedback controlled using a servo motor. Once the torque value is determined as the set value of the engine output and the real value is measured from the dynamometer, PID controller output is calculated using the below equation (3), which used to control the servo motor regulating the outlet valve. PID control algorithm was adopted to keep minimal the torque variation during the test operation of the engine.

The PID controller which applied in the study has the form of the equation (3). Due to the difficulty of modeling the engine and dynamometer, PID gain tuning was conducted using the trial-and-error method while the engine was running. Since the abrupt change of gain values may cause the engine

to fail, gain tuning should be done in cautious.

$$M_N = P_B \left\{ E_N + \frac{1}{T_i} \sum_{i=1}^N E_i \Delta T + T_d \frac{E_N - E_{N-1}}{\Delta T} \right\} \quad (3)$$

Here,

- M_N = Control Output
- E_N = Error (Set_point – Real value)
- P_B = Proportional gain
- T_i = Integral gain
- T_d = Derivative gain
- ΔT = Sampling time

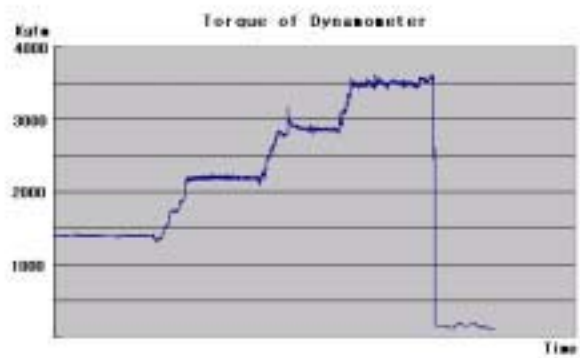

Figure 7. The result of manual control

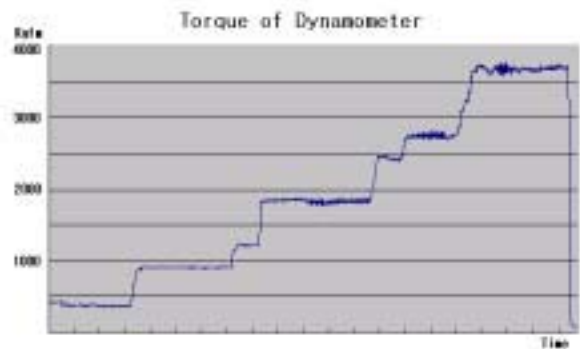

Figure 8. The result of PID control

The Fig. 7,8 are the measured data during dynamometer running. The Fig. 7 is shown a severe torque change during manual control of outlet valve. As the torque is high, this change is oscillated. But, in the Fig. 8, the change of a torque is smaller than that of Fig. 7 because of using the PID controller. The torque change occurred in allowable error range ($\pm 2\%$ of target torque) Here, it is important to set up gains of controller.

B) The Method of Schedule Operation

The dynamometer torque is changed like a Fig. 9 for performance test of the medium speed diesel engines. The changed torque($T_1 \sim T_4$) is kept for regulation time such as $t_1 \sim t_4$. Therefore, an operator must continuously check running time and must minutely adjust the inlet or outlet valve position to keep target torque. So, these are very inefficient. In this paper, we presented a solution which is schedule operation. The running dynamometer data in all cases is input to

schedule table by PLC program. If an operator plays the auto button in GUI, The dynamometer is worked automatically by the data of each case. However, we must carefully observe an engine driving characteristic during the schedule running because the engine can break down. Therefore, a schedule running is possible practically, but isn't easy.

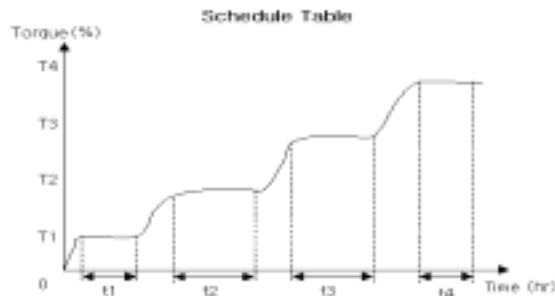

Figure 9. The schedule operation table

3. Development of web based remote control Program

The control system of dynamometer is operated in synchronization with engine system. So engine operating noise induces bad working environment and at every moment of changing engine load. An operator must move to engine operating panel. In this research, we developed a web based remote control system in the purpose of remedying the work environment and improving the reliability of shop test result. The developed web based remote control system consists of remote monitoring function and remote control function for mid-size dynamometer. This program communicates with dynamometer control system through LAN. Software consists of "schematic diagram" screen showing the status of components, "monitoring" screen showing the load torque and engine speed in chart form and "operation control" screen setting the opening rate and the load torque for dynamometer.

1) The screen of "Diagram"

Pushing "Diagram" TAP, we can see a window like fig 8. In this window user can see the power values of components and the alarm status at a glance. Pushing the "Parameter setting" button call "system setting" pop-up window, in this window user can change the alarm status setting values, newly changed values are automatically recorded as system parameter values.



Figure 10. The diagram

2) The screen of "Monitoring"

Pushing "Monitoring" TAP, we can see a window like fig 9.

In this window user can acquire the load torque and speed data of engine in chart form. these data are the most important data gathered from dynamometer. The X-Axis of the chart represents the time spent from monitoring start moment in second scale, the maximum representing time range in the chart is 10 seconds(default)



Figure 11. The Monitoring

3) The screen of "Operation"

Pushing "Monitoring" TAP, we can see a window like fig 10. In this window user can change manually the opening rate of inlet/outlet valves from remote place. With this function, we can monitor and control the dynamometer system from remote place. In the "Stop" mode, user can't change the open rate and the output load. In the "Manual" mode, user can change manually just the open rate of inlet/outlet valve. In the "Automation" mode, the open rate of inlet/outlet valve is automatically controlled to adjust the setting load.



Figure 12. The operation

4. CONCLUSION

The dynamometer which has the max absorption torque about 6,445.8 kgmf for an medium speed diesel engines has been developed. We designed newly the mechanical parts and the control system. The industrial PLC is used to control of inlet and outlet valve. The feedback control using servo motor in water outlet valve realized by PID algorithm. The engine performance test can be practiced with scheduling table. And, The web-based remote control system applied to this system. This system would offer convenience and improvement in system performance. After, this system will apply to others dynamometer such as a large size engine.

REFERENCES

- [1] P. G. Hodgson and J. K. Raine, "Computer simulation of a variable fill hydraulic dynamometer, Part 2: steady state and dynamic open-loop performance," *Proc. Instn*

Mech Enges , Vol. 206, pp.49-56, 1992.

- [2] P. G. Hodgson and J. K. Raine, "Computer simulation of a variable fill hydraulic dynamometer, Part 2: closed-loop performance," *Proc. Instn Mech Enges* , Vol. 206, pp. 327-336, 1992.
- [3] V.L. maleev, *Internal combustion engines*, Mcgraw-hill book company Vol., pp. 599-628, 1945.
- [4] Fuchino manufacturing co., Ltd., operation instruction for fuchino water brake of type.
- [5] C.S. Rangan, G.R. sarma and V.S.V. mani, *instrumentation device and system*, Mcgraw-hill book company Vol., pp. 222-239, 1983.