

주제 발표
(keynote speech)

OGC의 상호운용성 개발
Interoperability Works by OGC

2001. 11

Cliff Kottman
(Vice President, OGC, USA)

Interoperability Works by OGC

Cliff Kottman (cliff@opengis.org)
VP and Chief Scientist
Open GIS Consortium
November 2, 2001

© 2001, Open GIS Consortium, Inc. All Rights Reserved

OGC's Vision

- The complete integration of geospatial data and geoprocessing resources into mainstream computing



© 2001, Open GIS Consortium, Inc. All Rights Reserved

2

OGC's Approach

- **Not-for-profit Membership Organization**
 - Over 200 members
 - Global
- **Consensus Interface Specification at Implementation Level**
- **Enable Industry to Build Plug-and-Play Components**
- **Testbed Approach and Specification Development**



© 2001, Open GIS Consortium, Inc. All Rights Reserved

3

Example Members

- **Integrators**
 - Raytheon, Lockheed Martin, Mitsubishi, SAIC, Harris, TRW, BAE, ...
- **Major Hardware and Software Companies**
 - Sun Microsystems, Oracle, Microsoft, Adobe, HP, SAS, ...
- **Developers of GIS, Mapping, and Earth Imaging products**
 - Intergraph, ESRI, SICAD, AutoDesk, LaserScan, MapInfo, MapQuest, SmallWorld, PCI, ...
- **Government agencies that depend on geoprocessing**
 - NIMA, NASA, USGS, USA/CoE, USDA, NOAA, EPA, FEMA, DoT, Census, NSF, FGDC, Nat Res Canada, DMSO, UK/OS, Au/SA, ...
- **Others**
 - Content Providers, Telecom, Power, Universities, Startups, ...



© 2001, Open GIS Consortium, Inc. All Rights Reserved

4

Korean Members

- ETRI
- HanDong University
- INHA University
- National Geography Institute
- Pusan National Univ., Dept. of GIS
- Seoul Univ., School of Electrical Engineering



© 2001, Open GIS Consortium, Inc. All Rights Reserved

5

The Topics

- Introduction to the Open GIS Consortium
- Consensus-producing Mechanisms
- Achievements and Future Plans
- Markets, Architectures, Services, and SCOTS (Standards-based Commercial-off-the-Shelf)



© 2001, Open GIS Consortium, Inc. All Rights Reserved

6

OGC's Final Deliverables

- **Interoperable Interface Specifications**
 - Sometimes de jure Standards
 - Independent of Platform to the Extent Possible
- **Testbeds and Working Models**
 - Teams for Development and Marketing
 - Prototypes of Emerging Markets
- **SCOTS (Standards-based-Commercial-off-the-Shelf Software)**
 - From our Members
 - Plug and Play
- **Studies and Experiments**



© 2001, Open GIS Consortium, Inc. All Rights Reserved

7

The Emerging GIS Market

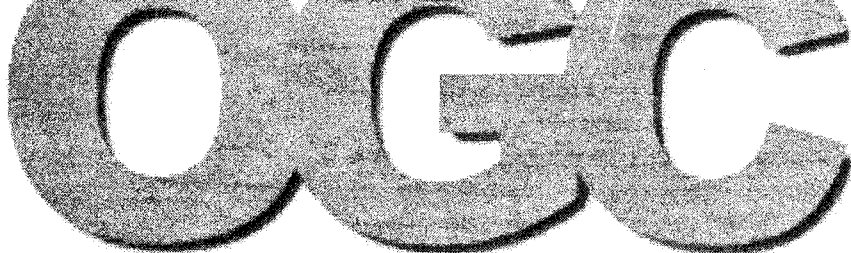

© 2001, Open GIS Consortium, Inc. All Rights Reserved

Yesterday's GIS Monolith

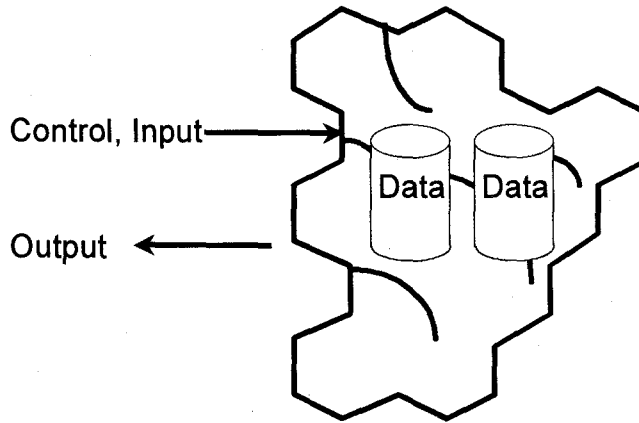

C. 1977



© 2001, Open GIS Consortium, Inc. All Rights Reserved

9

The Trend to a 3-Tier Architecture

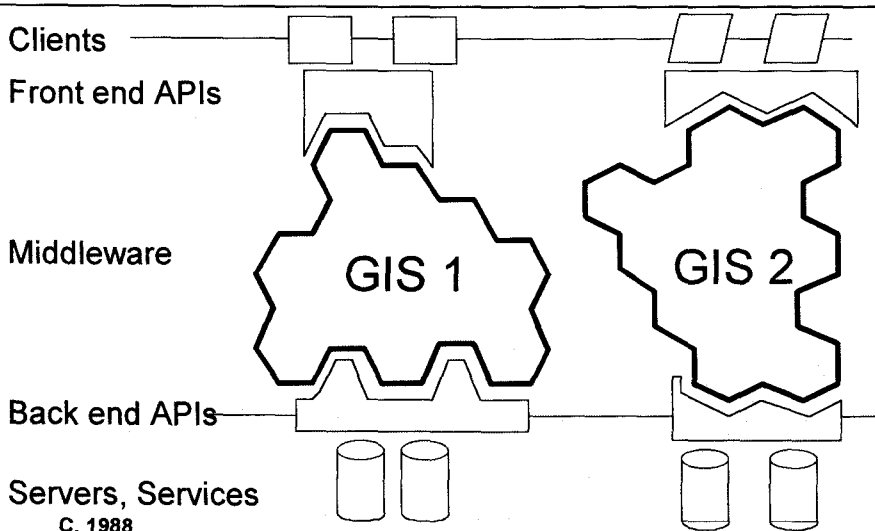

C. 1988



© 2001, Open GIS Consortium, Inc. All Rights Reserved

10

Middleware

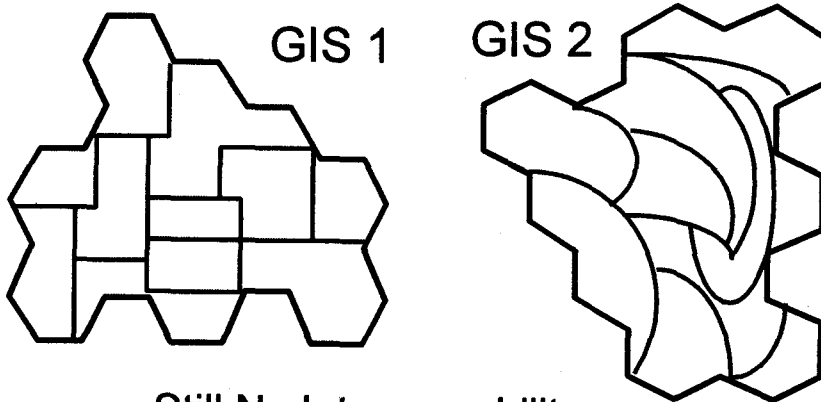

Still No Interoperability



© 2001, Open GIS Consortium, Inc. All Rights Reserved

11

Isolate Functionality

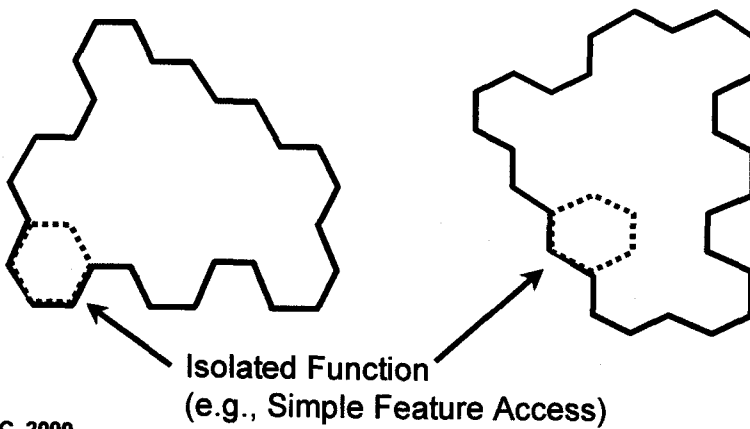

C. 2000



© 2001, Open GIS Consortium, Inc. All Rights Reserved

12

An Interoperable Component

Standards-based Commercial-off-the-Shelf

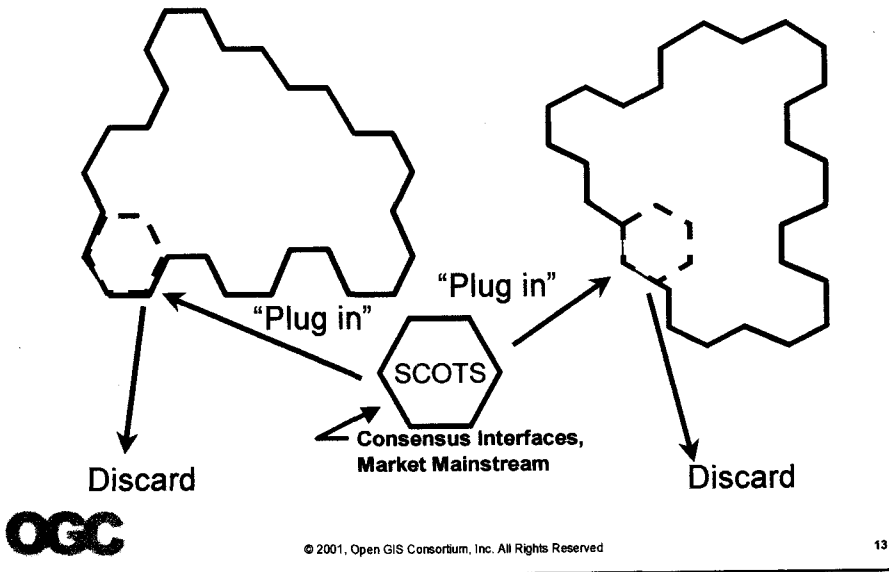

Isolate and COTS-ify Functionality

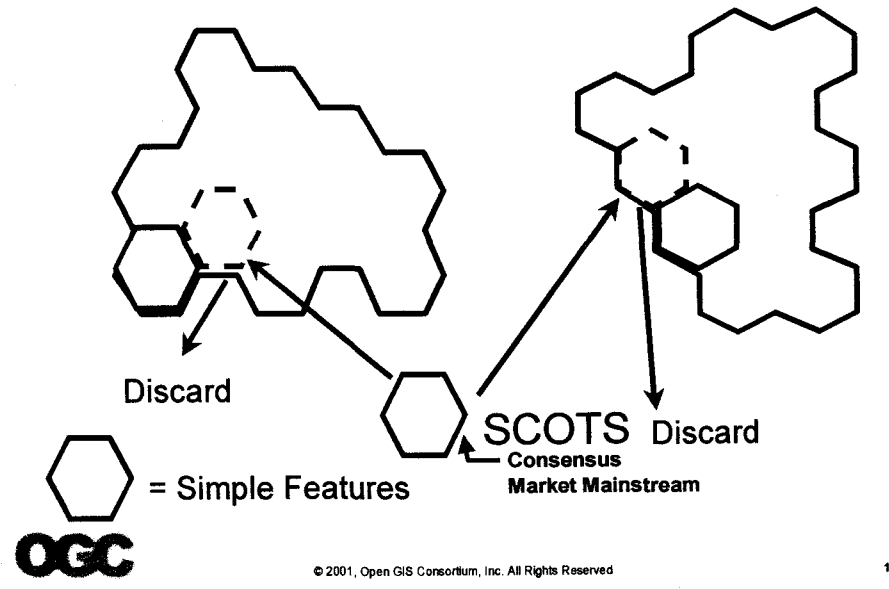

Increasing Interoperability Scope

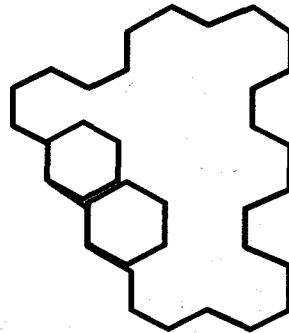
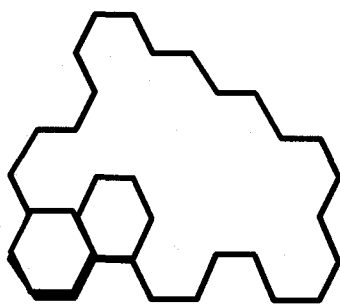

= Simple Feature Access



= Gridded Coverage Services



© 2001, Open GIS Consortium, Inc. All Rights Reserved

15

Fully Componentized (SCOTS-ified)

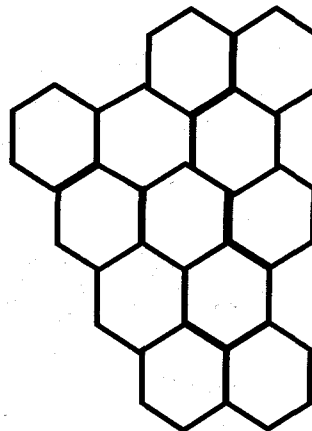
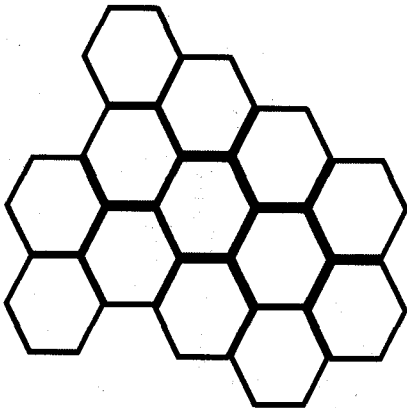

Where is the Geospatial Information Infrastructure?
It is in the consensus on the red boundaries.



© 2001, Open GIS Consortium, Inc. All Rights Reserved

16

The Market

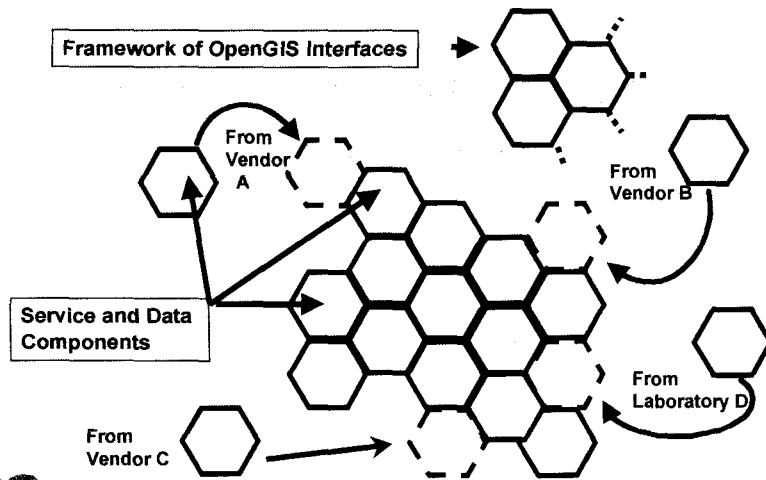

Framework and Service Modules

The Framework, and the Service Modules, define the "clumps" of technology that enable and establish a market

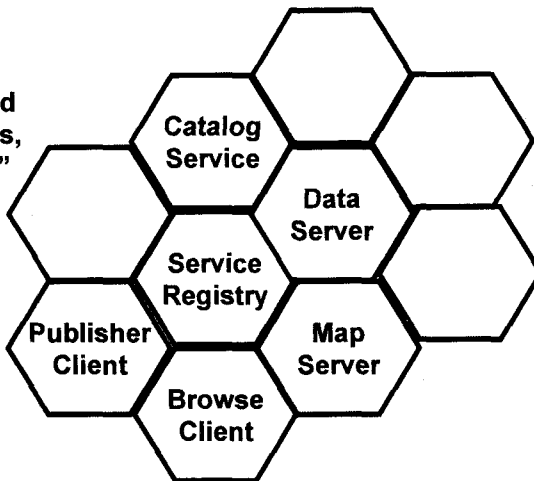

Some Architecture Concepts



© 2001, Open GIS Consortium, Inc. All Rights Reserved

The Fundamental Architecture

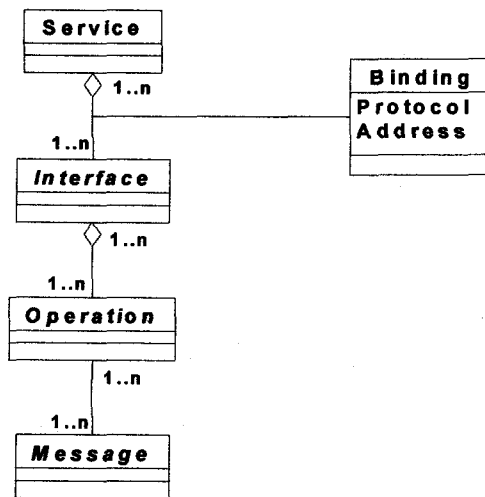

© 2001, Open GIS Consortium, Inc. All Rights Reserved

20

The Component/Functional Architecture

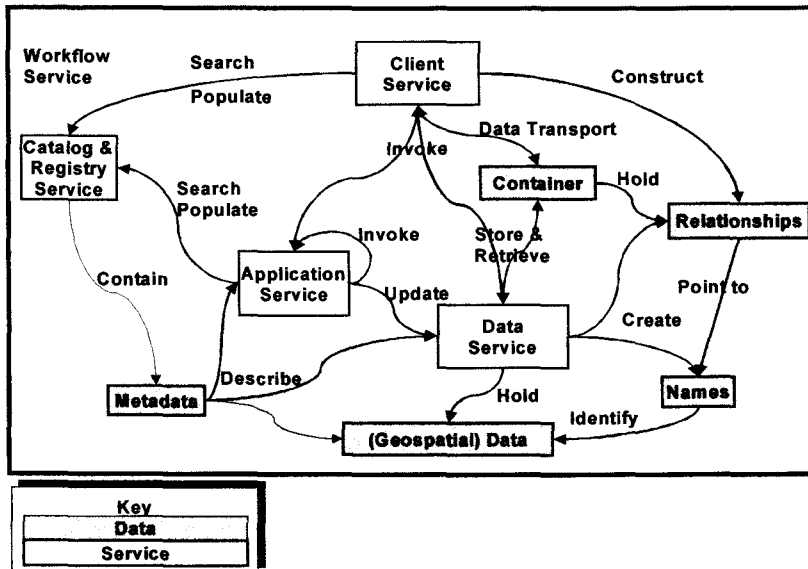

A Service Architecture

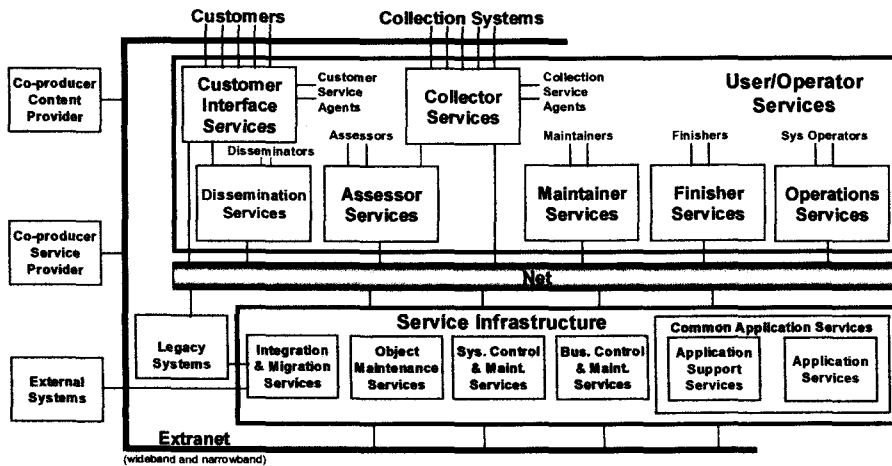

The Fora

- TMC = Traffic Message Channel
- ETSI = European Telephone Stds Inst.
- The OpenGroup's Mobility Management Forum
- DMTF = Distributed Management Task Force
- MWIF = Mobile Wireless Internet Forum
- IAI = International Alliance for Interoperability
- OpenGIS
 - OpenLS
 - Web3D
- IETF Spatial
 - WAP Forum
 - MOPA
- ISO and other de jure
 - MAGIC
 - LIF
- SynchML
 - GRC International
 - W3C
- Lucent Public Safety
 - IEEE



© 2001, Open GIS Consortium, Inc. All Rights Reserved

23

The Emerging Role of "Consortia" in Creating Orderly Markets

- **Bring developers and users together**
- **Work with users to define requirements and "value chains"**
- **Define "fundamental technology interfaces" based on "business modeling"**
- **Create "institutional interfaces" based on technical interoperation and definition of "joint requirements"**

Consortia create the Agreements & Interfaces on which industry "Value Chains" are based!



© 2001, Open GIS Consortium, Inc. All Rights Reserved

24

The Web Mapping Era

(before)

© 2001, Open GIS Consortium, Inc. All Rights Reserved

Before WMT

TerraServer - <http://terraserver.microsoft.com>

MapQuest - <http://www.mapquest.com>

EPA - <http://www.epa.gov/enviro/enviromapper.html>

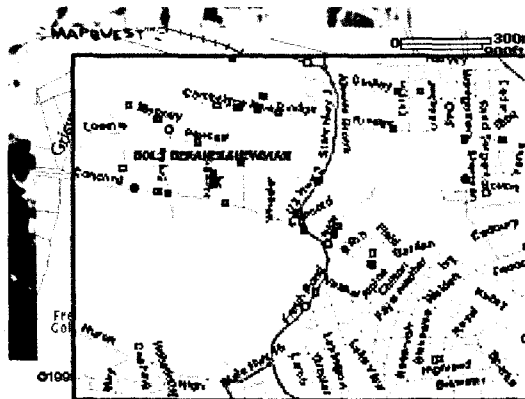

© 2001, Open GIS Consortium, Inc. All Rights Reserved

26

The Web Mapping Revolution

(after)

© 2001, Open GIS Consortium, Inc. All Rights Reserved

After WMT - Basic Architecture



```
http://a-map-co.com/mapserver.cgi?WMTVER=0.9&REQUEST=map&
SRS=4326&BBOX=-88.68815,30.284573,-87.48539,30.989218&
WIDTH=792&HEIGHT=464&
LAYERS=STUSA%3ACubeWMT,Landsat%3AMIT-lsat&
STYLES=TRANSPARENT%2FBLACK,Default&FORMAT=PNG&
BGCOLOR=0xFFFFFFFF&TRANSPARENT=FALSE&EXCEPTIONS=INIMAGE&
QUALITY=MEDIUM
```

```
http://b-map-co.com/servlets/mapervlet?WMTVER=0.9&
REQUEST=map&BBOX=-88.68815,30.284573,-87.48539,30.989218&
WIDTH=792&HEIGHT=464&SRS=4326&
LAYERS=AL+Highway,AL+Highway,AL+Highway&
STYLES=casing,interior,label&FORMAT=GIF&TRANSPARENT=TRUE
```



File Edit View Go Communicator Help

Back Reload Home Search Netscape Print Security

Bookmarks Location: 702¤tScale=180¤tImageWidth=560¤tImageHeight=350¤tSrs=4326¤tImageType=PNG¤tQuality=MEDIUM

Instant Message WebMail Contact People Yellow Pages Download Find Sites Channels

Legend:

- County Boundaries
- Streams
- Wetlands

Details Reset

zoom in zoom out recenter query on: (none)

Data Stores: USLPP Selected Layers: County Boundaries Up
 Themes: ENVIRONMENTAL - OTHER Streams Down
 Layers: Wetlands Remove

File Edit View Go Communicator Help

Back Reload Home Search Netscape Print Security

Bookmarks Location: 702¤tScale=180¤tImageWidth=560¤tImageHeight=350¤tSrs=4326¤tImageType=PNG¤tQuality=MEDIUM

Instant Message WebMail Contact People Yellow Pages Download Find Sites Channels

Legend:

- Landsat image mosaic
- Shaded elevation
- County Boundaries
- Streams
- CITIES

Details Reset

zoom in zoom out recenter query on: (none)

Data Stores: SAIC/ESRI Selected Layers: Landsat image mosaic Up
 Themes: POPULATION Shaded elevation Down
 Layers: CITIES County Boundaries Remove
 Streams
 CITIES

Trends

OLD

- GIS
- Government Led
- Stand-Alone Spatial Services
- Focus on Portrayal & Analysis
- De Jure/Private Standards
- Abstract Specifications
- Custom/ Proprietary Identifiers
- Expert Driven
- Isolated GIS Services

NEW

- Location-Based Services
- Industry Led
- Spatial Services Integrated into Business Objects
- Focus on Many Services
- Industry Consensus Standards
- Implementation Details
- XML and GML
- Market Driven
- In Command and Control Loop



© 2001, Open GIS Consortium, Inc. All Rights Reserved

31

The OGC Interoperability Program (IP)

© 2001, Open GIS Consortium, Inc. All Rights Reserved

Task A

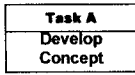

Develop a Concept

... Inception & Elaboration

... Gather Sponsors

(First of Eight Tasks)



Task A Details

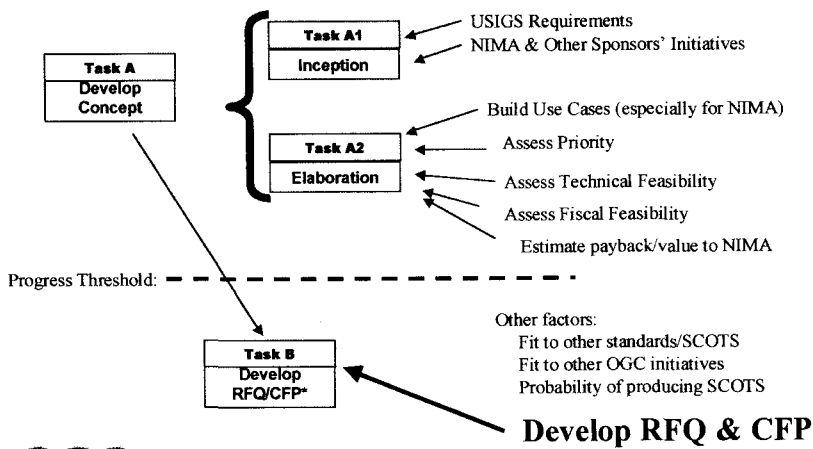

Exit Check for Progress to Task B

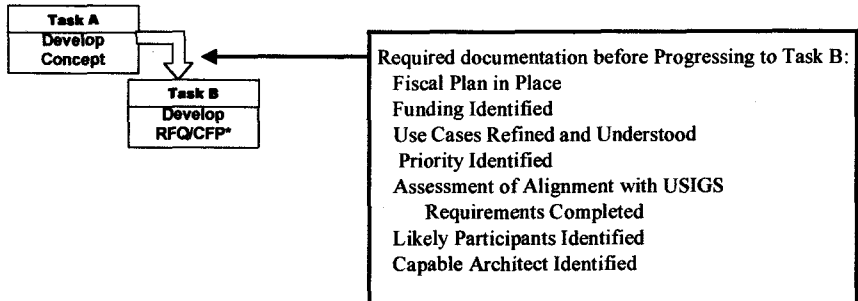

Task B Details

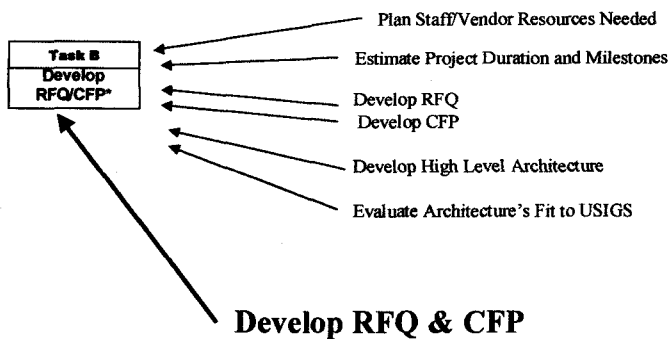

Exit Check for Progress to Task C

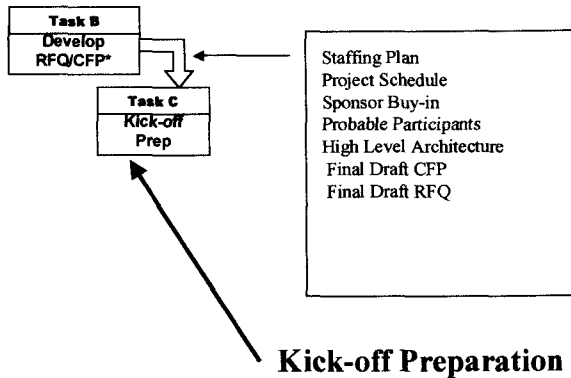

Task C Details

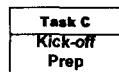

- Issue CFP
- Amend and Clarify as necessary
- Evaluate Technologies in Responses
- Modify/Refine the Architecture
- Modify Use Cases and Scenarios as Appropriate
- Assess value of Use Cases and Scenarios to USIGS
- Issue RFQ
- Negotiate Rolls and co-pay arrangements with Participants
- Modify Use Cases and Scenarios as Appropriate
- Assess value to USIGS
- Identify Interfaces in scope of project
- Set up teams and TIES
- Establish Project WBS and milestones.
- Stand up a concept of a demo (as appropriate)
- Assess value of demo to USIGS
- Finalize Use Case Details and TIE Details:
 - data
 - platforms
 - personnel etc.

Kick-off Preparation



Exit Check for Progress to Task D

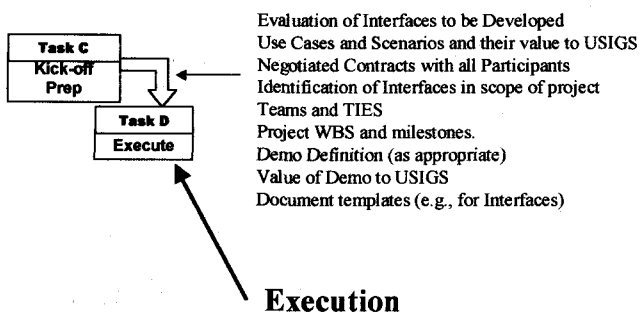

Task D Details

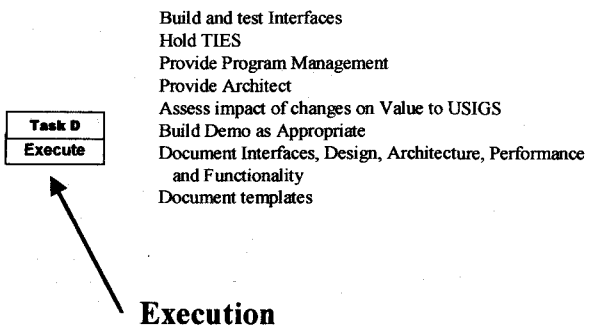

Exit Check for Progress to Task E

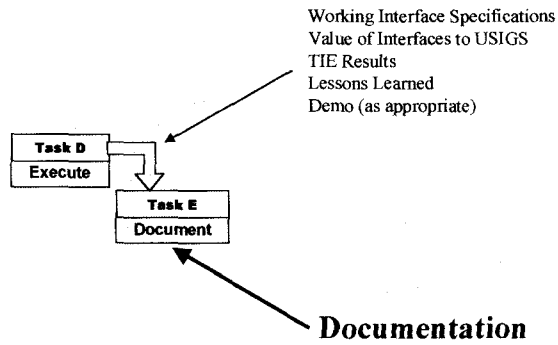

Task E Details

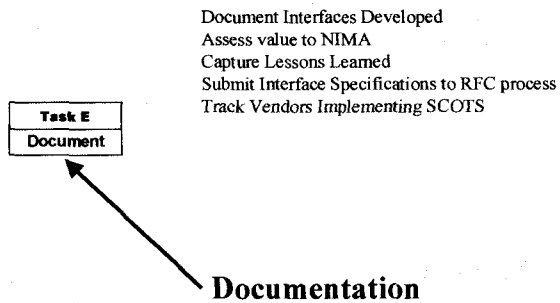

Exit Check for Progress to Task F

**Build
Consensus**

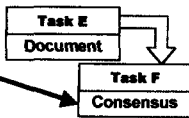

Complete ISO Template version of Interfaces
Plan for Gathering Consensus
as Discussion Papers
as IPR/DIPR
as Recommendation Papers
for Submittal to RFC Process
Submittal to ISO for IS Status (as appropriate)
Documentation supporting ISO steps
Service as experts and project leaders
Assessment of value to USIGS



Exit Check for Progress to Task G

Assessment of Need of Maintenance
Assessment of Need of Maintenance from a USIGS perspective
Development of new Use Cases from USIGS perspective

Maintain

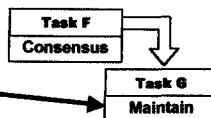

Typical IP Process

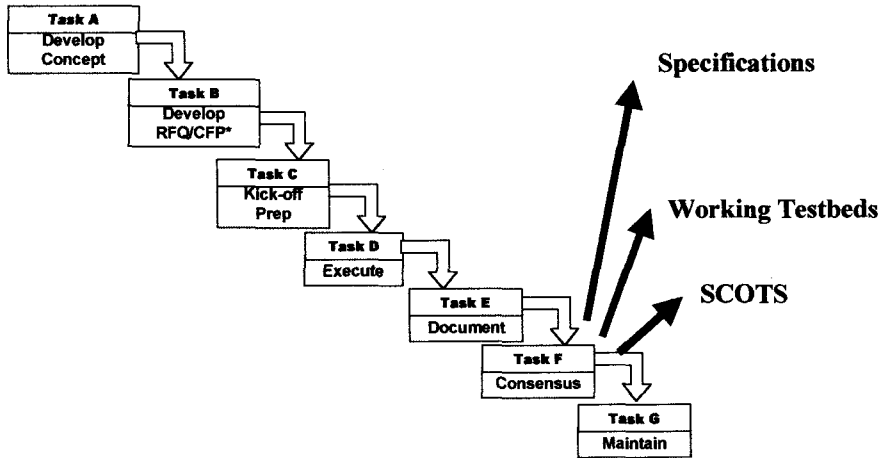

OGC Planning Process

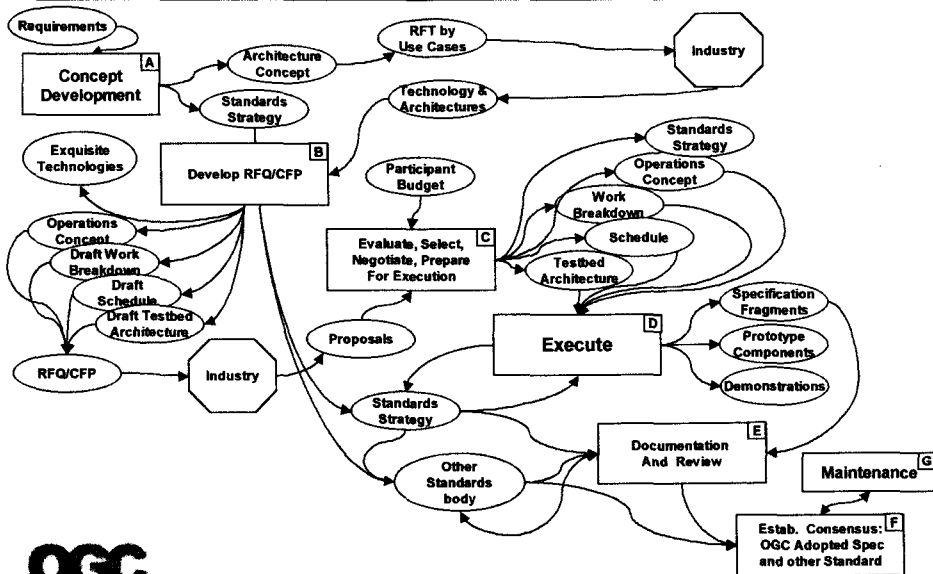

Concept Development Factors

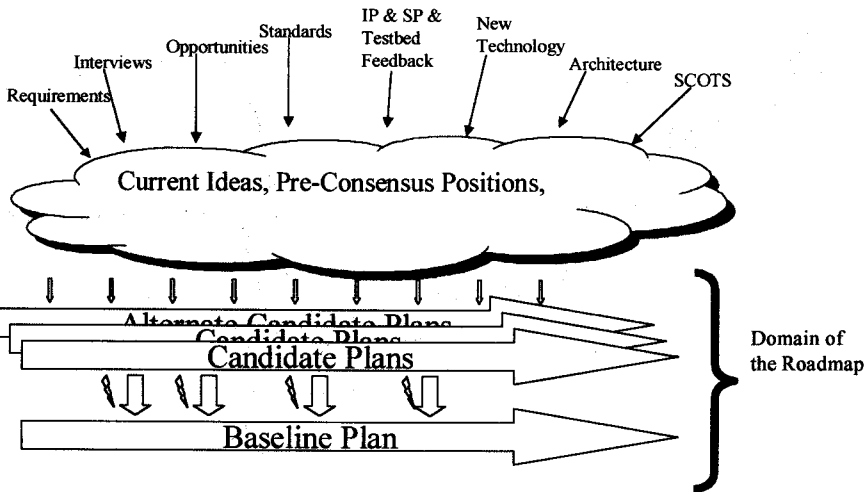

© 2001, Open GIS Consortium, Inc. All Rights Reserved

47

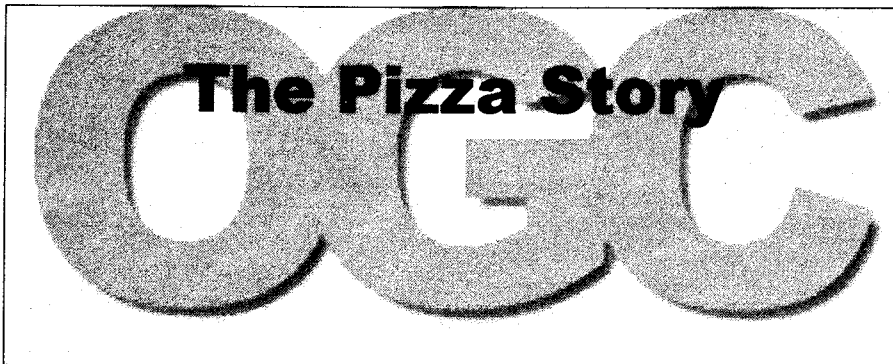

© 2001, Open GIS Consortium, Inc. All Rights Reserved

The Pizza Story

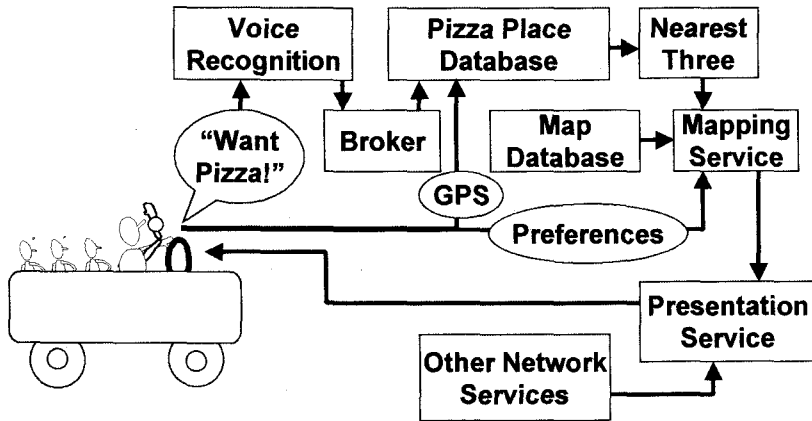

OGC

© 2001, Open GIS Consortium, Inc. All Rights Reserved

49

An Infrastructure of Agreements

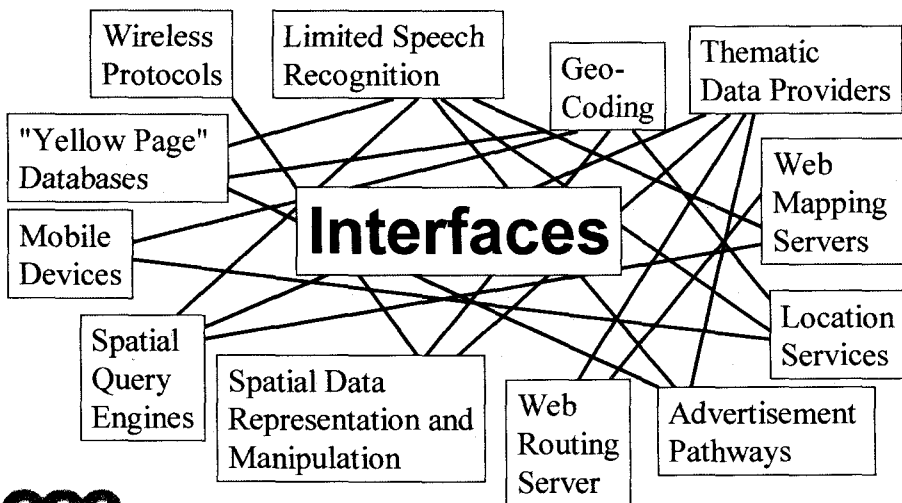

OGC

© 2001, Open GIS Consortium, Inc. All Rights Reserved

50

What's an Interface?

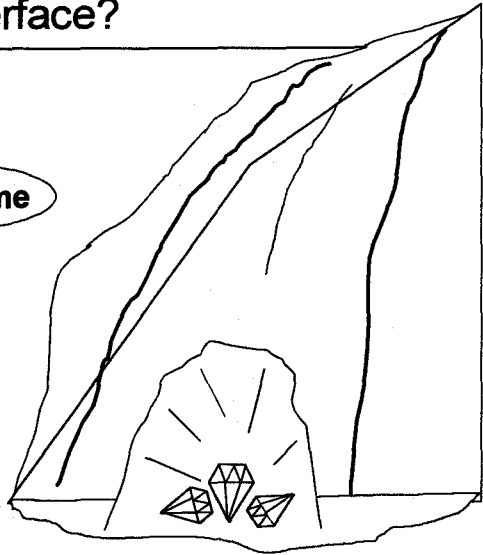
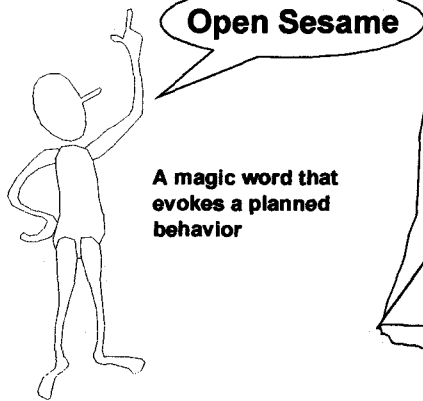

Soldier Story

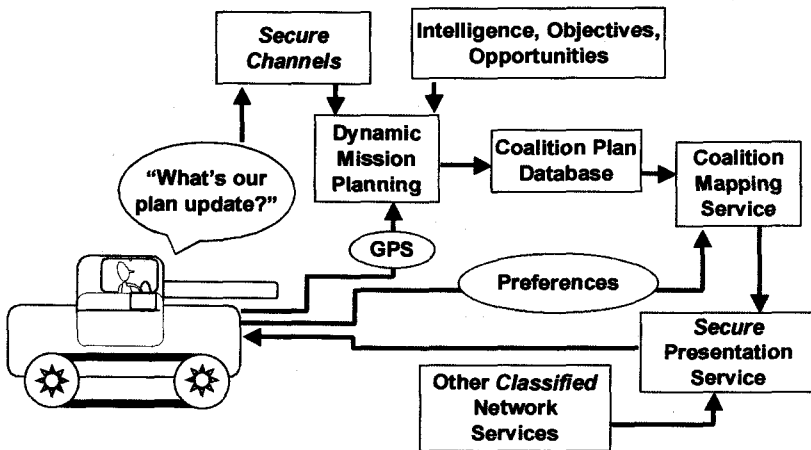

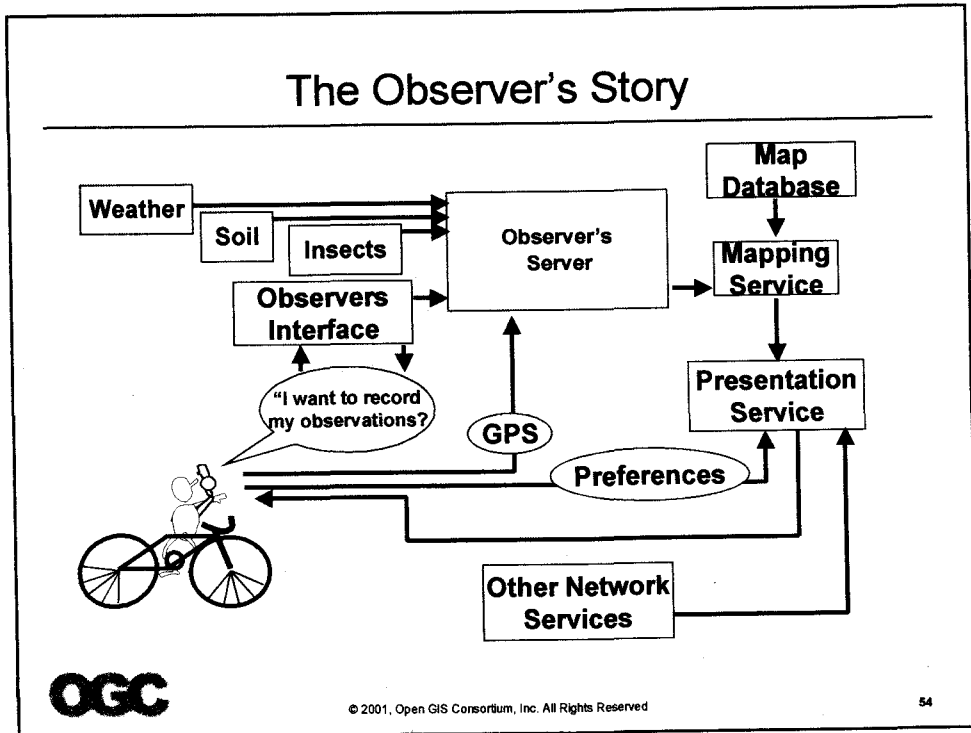
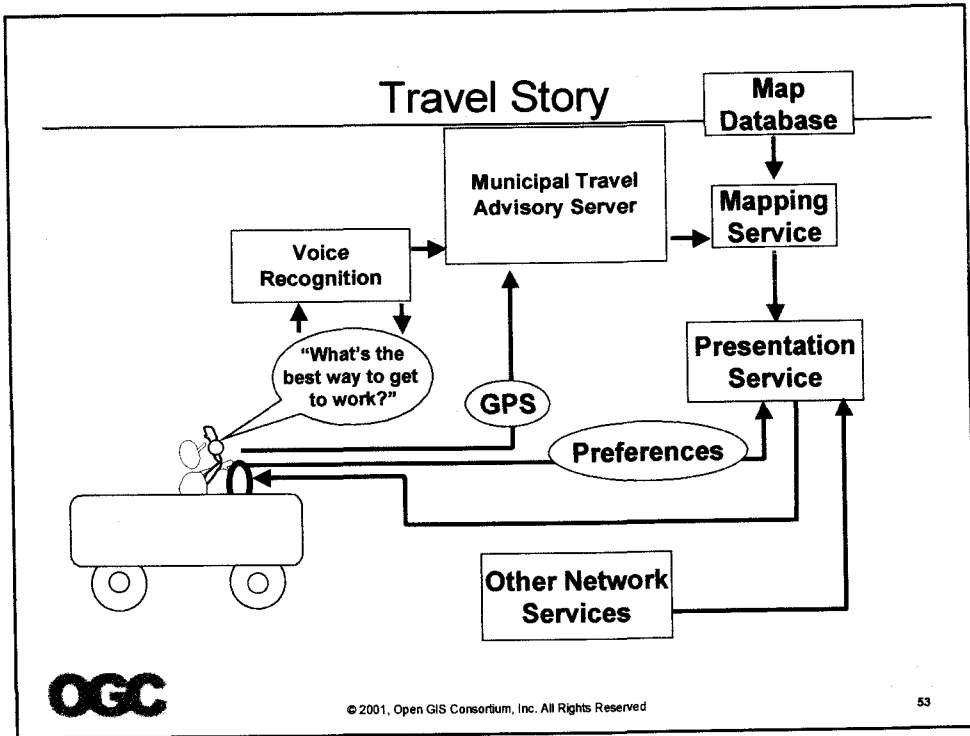

The Learning Story

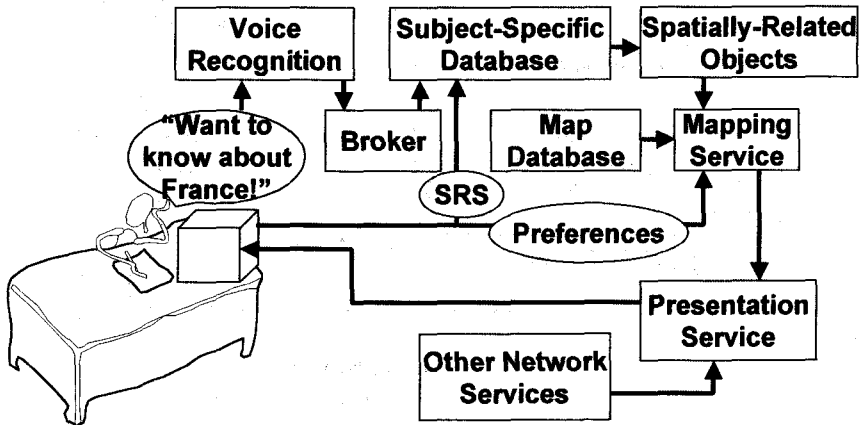

OGC

© 2001, Open GIS Consortium, Inc. All Rights Reserved

55

New Businesses

- Mobile GIS
 - Brokered
 - Direct
- Advertising
- Geographic Content Service Providers
- Yellow Pages
- System and Application Manufacturing
- Portable Geographic Content & Services

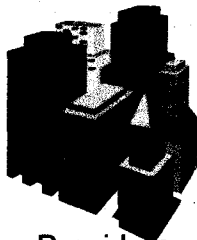

OGC

© 2001, Open GIS Consortium, Inc. All Rights Reserved

56

Location Services Architecture

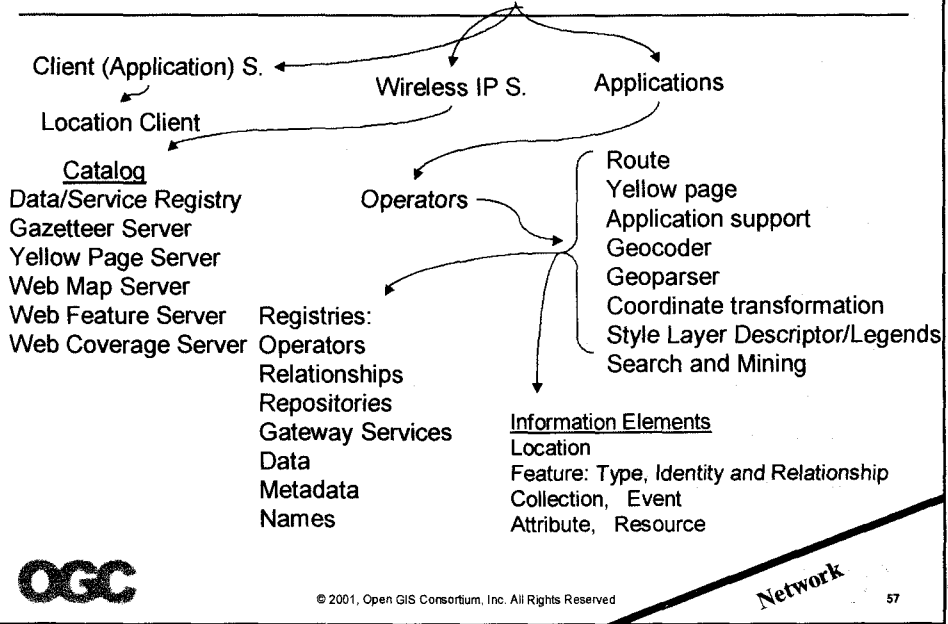

Achievements and Future Plans



Approved Specifications

• Spec Name	Status
• Simple Features Service – OLE/COM	Approved
• Simple Features Service – CORBA	Approved
• Simple Features Service – SQL	Approved
• Web Map Service	Approved
• Coordinate Transformation Services	Approved
• Catalog Services	Approved
• GML (Geography Markup Language)	Approved
• Grid Coverage Service	Approved



© 2001, Open GIS Consortium, Inc. All Rights Reserved

59

Specifications Nearing Adoption

• CT Definition Data for Coordinate Reference	Recommendation
• Units of Measure	Draft Recommendation
• Geocoder	DCIS as a Discussion Paper
• Gazetteer	DCIS as a Discussion Paper
• Geoparser	DCIS as a Discussion Paper
• Location Organizer Folder (LOF)	DCIS as a Discussion Paper
• Web Feature Server (WFS)	DCIS with intent to submit as RFC
• Filter Encoding	DCIS with intent to submit as RFC



© 2001, Open GIS Consortium, Inc. All Rights Reserved

60

More Specifications Nearing Adoption

- | | |
|--|----------------------------|
| • Basic Services Model | DCIS as a Discussion Paper |
| • Web Registry Service | DCIS as a Discussion Paper |
| • Stateless Catalog | DCIS as a Discussion Paper |
| • Style Layer Descriptor | DCIS as a Discussion Paper |
| • XML for Image and map
Annotation (XIMA) | DCIS as a Discussion Paper |
| • Web Terrain Server | DCIS as a Discussion Paper |



© 2001, Open GIS Consortium, Inc. All Rights Reserved

61

Planned Specifications for OLS

- | | |
|------------------------------------|---------|
| • Determine Route | Planned |
| • Routing Directions | Planned |
| • Display Route Vector Service | Planned |
| • Get Traffic Service | Planned |
| • Get Proximity Directory Services | Planned |
| • Reverse Geocoder Service | Planned |
| • Get Pinpoint Directory Service | Planned |
| • Get Location Service | Planned |
| • Get Device Location Service | Planned |



© 2001, Open GIS Consortium, Inc. All Rights Reserved

62

Other Initiatives

General Services Model	In progress
• Sensor Collection Service	Planned
• Sensor Description Language	Planned



© 2001, Open GIS Consortium, Inc. All Rights Reserved

63

Thank You



© 2001, Open GIS Consortium, Inc. All Rights Reserved