

속도변동에 의한 증류확산환열의 응답

신 현 동 (한국과학기술원)

속도변동에 의한 중류확산화염의 응답

한국과학기술원 기계공학과

신 현 동

Motivation

Combustion phenomena and modeling being treated with counter type combustor

- Interaction between combustion reaction and eddy motion of reactive flow
- Scalar field information with reactive turbulent flow
- The response of flame for the velocity variation

Impulsive Variation of Strain Rate

By Mauss

METHOD : Increasing and decreasing of strain rate

RESULT : Flamelet extinction and re-ignition by the time of excessive strain rate

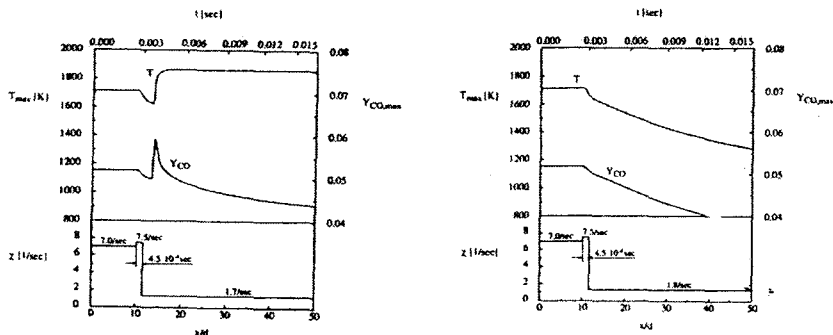

Step and Constant Variation

By Darabiha

METHOD :

Step variation of linear increasing strain rate

RESULT :

The time delay between extinction limit & maximum flame temperature exists

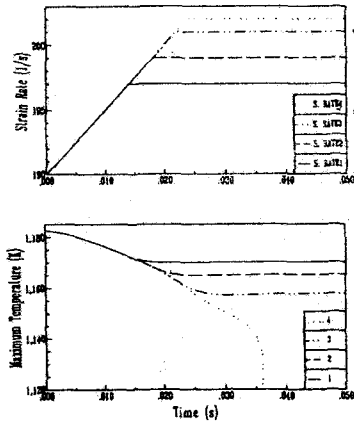

Monotonic Decreasing Variation

By Park & Shin

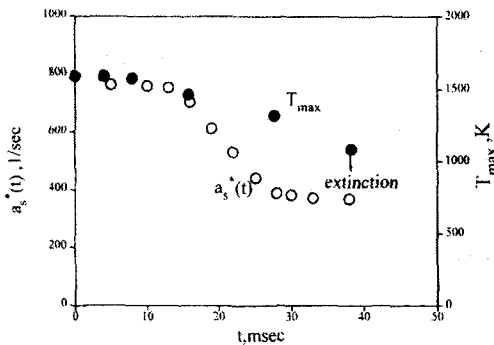

METHOD :

Simulation of starting fuel jet ignited by residual flame with counter flow diffusion flame

RESULT :

Flame response of unsteady strain rate shows the behavior of middle branch at the S-curve

Oscillatory Variation

By Saitoh & Otsuka

METHOD : Flow oscillation in counterflow geometry

RESULT : The amplitude of temperature or concentration fluctuation decrease with the increasing of the frequency of velocity

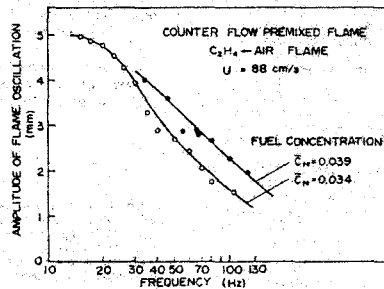
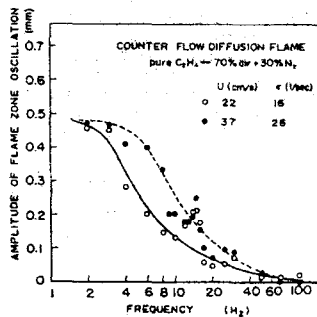

Linear Variation

Analysis Methods

- Experiment
 - Experiments are set with evolving jet diffusion flames.
 - In the moving coordinate of fuel vortex, air stream velocity is changed with time
 - Similarity with counterflow cf. $a_s = \frac{3V(t)}{2R(t)}$
- Asymptotic Method
 - Based on LAE asymptotic, unsteady responses have been studied.
- Modeling
 - Response of Linearly varying strain rate is parameterized with the similarity variable of Stoke's first problem.

• Experimental Setup & Result

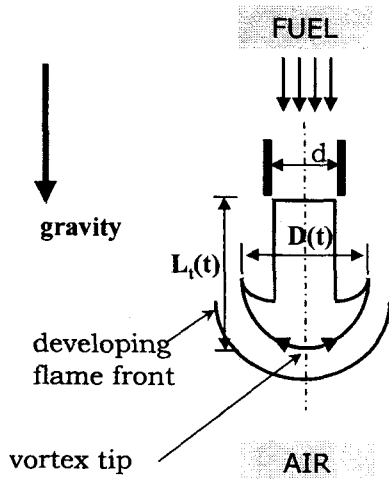

d : nozzle diameter
 $D(t)$: diameter of fuel vortex
 $L_t(t)$: vortex tip penetration length

Strain Histories : CH₄

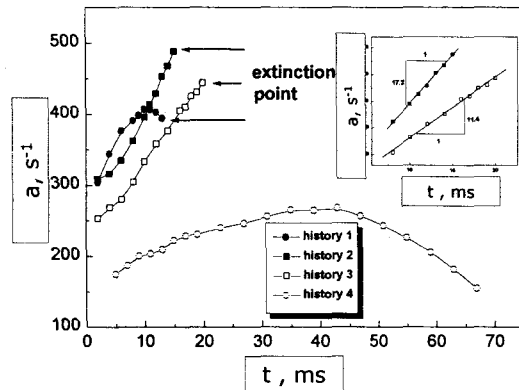

• Modeling (crude estimation)

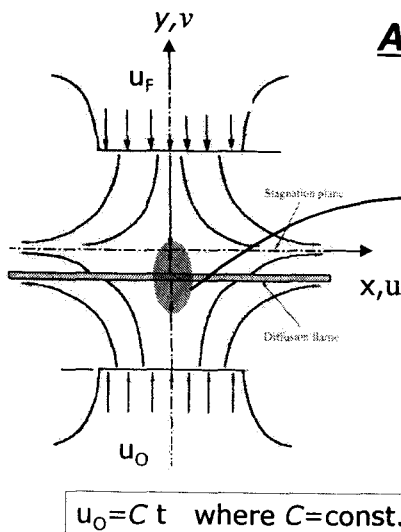

Analogy to Stoke's 1st Problem

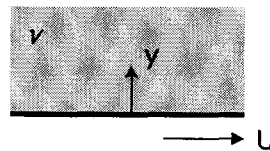

- The similarity variable from Stoke's first problem

$$\eta = \frac{y}{2\sqrt{vt}}$$

y : displacement to diffusion layer
 ν : kinematic viscosity

Results of Extinction Limit by Various Methods

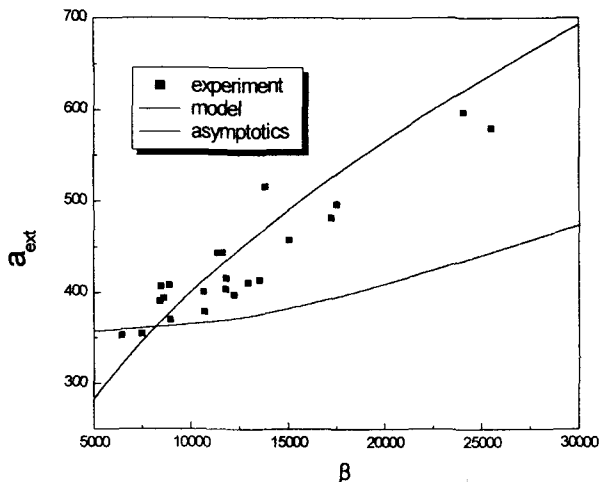

a_0 : initial strain rate

$a_{E,0}$: steady extinction strain rate

a_{ext} : unsteady extinction strain rate

$\beta (=da/dt)$: slope of strain rate

$n_{ext} = 4$ for this model

Conclusion

1. Unsteadiness of Diffusion Flames

- Cases of quenching flames

- a_{ext} is extended with increasing the da/dt
- Strongly influenced by da/dt near the extinction point

- Cases of non-quenched flames

- Two distinct T_{max} exist at the same strain rate
- T_{max} of the flame undergoing a high strain rate is always lower

2. Analysis of the Results

- Asymptotic Method

- a_{ext} exceeds the steady one and is extended by the flow unsteadiness
- The tendency of the extension is different from experimental result

- Analogy to Stoke's 1st Problem

- The extension of extinction has good agreement to experimental result
- More verification for modeling should be conducted by numerical simulation