

왕복동 압축기에서의 고효율, 저소음 흡입머플러 개발

Smart Suction Muffler for a Reciprocating Compressor

°주재만*, 최진규**, 오상경*, 박성우***

ABSTRACT

Suction muffler is one of the important component of a compressor for low noise level and high efficiency. The suction muffler which has the complicated flow path gives the higher transmission loss of sound, but lower efficiency of compressor results from the superheating effect and flow loss in suction flow path. It is shown that the computational analysis of fluid dynamics are very popular methods for designing of high performance and low noise suction muffler. To reduce the thermodynamic and flow loss in suction process, the flow path of suction muffler was estimated by FVM(Finite Volume Method) and verified by experiments. And to enlarge the transmission loss of sound, the acoustic properties inside the suction muffler was analyzed by FEM(Finite Element Method) and experiments. The smart muffler which gives a good efficiency and low noise character was developed by using those methods, and the effect was evaluated in compressor by experiment.

INTRODUCTION

The performance of a reciprocating compressor is influenced by the state of suction gas which is determined by the flow path to cylinder. Generally, the suction muffler has the complicated flow path for the high transmission loss of sound. Most suction muffler has been designed in this viewpoint.[3] But lower efficiency of a compressor results from the superheating effect and flow loss in complex suction flow path. Therefore, the flow field and sound field of a suction muffler are considered at the same time. In this paper, the smart suction muffler is studied for a good efficiency and low level noise character mainly.

OPTIMAL DESIGN

Design Procedure of a Suction Muffler

The suction muffler of a compressor is used to reduce the valve system noise generated for suction process. Generally the flow path of a muffler is complicated to reduce sound of compressor effectively. According to the geometric complex of muffler, the hydraulic and thermodynamic losses which affected to the performance of compressor fatally are occurred. We could obtain the optimal design for suction muffler by using computational fluid flow and acoustic analysis technique. Fig.1 shows the design process of a smart suction muffler.

* 삼성전자 냉공조(사) 선행연구그룹, ** 삼성전자 냉공조(사) 냉장고개발그룹,

*** 삼성광주전자 압축기개발그룹

Superheating Effect of Suction Gas

What we want to determine the optimum design parameters of a suction muffler is understanding the relation between temperature rising and the variation of performance characters by superheating effects. The performance of a compressor is varied largely by suction gas temperature sucked cylinder of a compressor. Fig.2 shows the positions of thermocouple which is established to measure temperature change when temperature of suction pipe is varied by temperature controller.

Fig.3 tells the temperature distributions at the flow path inside a suction muffler when temperature of suction pipe is varied. Table 1 shows the performance of a compressor on each temperature of suction pipe. Generally the performance of a compressor is inverse to the temperature of suction gas which influence directly to that of discharge plenum. Also cooling capacity and input power are same inverse proportion to the temperature of suction plenum. If temperature of suction plenum rise, then input power decreased because the mechanical loss decrease cause of decreasing the oil viscosity. On the other hand, the efficiency is reduced as the cooling capacity is more decrease than input power as shown in Fig.4, the cooling capacity is inverse proportion to the temperature of a suction plenum.

Influence of a Pressure Loss

A pressure loss which was generated in a suction muffler reduces the performance of a compressor seriously. To find out these effects, the pressures of inlet and outlet of suction muffler are measured and pressure drop is evaluated. We have 2 different shapes and flow path of suction muffler, as shown in Table 2, which are applied to the compressor. Cooling capacity, which depends on the suction refrigerant, of case 2 is larger than case 1 because of less pressure loss in suction process.

Analysis of the Flow Field and Transmission Loss

In general, the temperature of suction gas which sucked into cylinder must be low, if possible. So flow field analysis are carried out for designing the suction muffler of which hydraulic loss are minimized in flow path. Sound frequencies, which was generated by pulsating wave in suction valve system, are 500Hz in 1/3 octave band. These sound exited shell inside of compressor through suction muffler. We have to design the suction muffler which has maximum transmission loss of this 500Hz. Sound field analysis is carried out for suction muffler which was pre-designed by flow field analysis. Navier-Stokes equations are used for analysis flow field of suction muffler.

$$\frac{\partial p}{\partial t} + \frac{\partial}{\partial x_i}(\rho u_i) = S_m \quad (1)$$

$$\frac{\partial}{\partial t}(\rho u_i) + \frac{\partial}{\partial x_j}(\rho u_i u_j) = -\frac{\partial p}{\partial x_i} + \frac{\partial \tau_{ij}}{\partial x_j} + \rho g_i + F_i \quad (2)$$

$$\frac{\partial}{\partial t}(\rho h) + \frac{\partial}{\partial x_j}(\rho u_j h) = \frac{\partial}{\partial x_i}(kT) + S_h \quad (3)$$

To solve these equations, Ideas Master Series 6.0 as pre-process and Fluent 5.0(Unstructure version) as solver are used. Physical properties and boundary conditions are in Table 3. FEM grids are created using solid model for flow field analysis. Sound field analysis are solved by SYSNOISE. Transmission loss are calculated by followed equations. And the transmission loss was measured by experimental method for verification.

$$TL=20\log\{0.5[|A_{11}+(A_{12}/(\rho c)+A_{21}\rho c+A_{22})|]\} \quad (4)$$

where,

$$\begin{aligned} A_{11} &= P_1 / P_o, & V_o &= 0 \\ A_{12} &= P_1 / V_o, & P_o &= 0 \\ A_{21} &= V_1 / P_o, & V_o &= 0 \\ A_{22} &= V_1 / V_o, & P_o &= 0 \end{aligned} \quad (5)$$

Fig.5 shows the grids which used in solving flow and sound field analysis. For improving the performance of a compressor, the superheating effect and pressure loss in suction muffler should be minimized. We replaced the suction muffler type A, double simple expansion chamber type, to type B, simple expansion chamber type, in order to get the maximum transmission loss.

Fig.6 and 7 show the result of flow field analysis for type A and type B. Pressure loss occurs so much in baffle of type A muffler because there is the bottle neck effect. To reduce this pressure loss, inner shape of muffler is simplified and venturi type tube is adopted to minimized recirculated flow in the suction muffler. Total hydraulic losses are reduced in suction process by using type B muffler in which pressure losses are occurred a little.

Fig.8 shows the transmission loss by analytical results and those of experimental results in Fig.9. As we compare these results in quality, we obtain good relationship between analytical and experimental results.

Table 4 shows the result of type A and type B with ASHRAE condition in the compressor. Fig.10 shows that type B has some better results to control the frequency characteristics than type A in low frequency band.

CONCLUSIONS

- The performance of a compressor is affected by superheating effect of suction gas.
- The performance is reduced and input

power of compressor is increased, when the hydraulic losses are increased in suction flow path.

- Flow field analysis is carried out for reducing pressure loss, and flow path of suction muffler is optimized by simplifying flow path and reducing recirculated flow.
- Flow field and sound field analysis of suction muffler are proceeded at the same time, to optimum design for suction muffler.

REFERENCES

- [1] M.L. Munjal, Acoustics of Ducts and Mufflers, John Wiley & Sons
- [2] Fluent 5 User's Guide, Fluent Incorporated
- [3] P.K.Roy, S.G.Hix; Bristol Compressors, USA; Higher Efficiency, Lower Sound, and Lower Cost Air Conditioning Compressors: Part1 - Efficiency. 1998 International Compressor Engineering Conference at Purdue, USA. Vol.2. P.707-711.
- [4] P.K.Roy, S.G.Hix; Bristol Compressors, USA; Higher Efficiency, Lower Sound, and Lower Cost Air Conditioning Compressors: Part2 - Sound/Discharge Pulse. 1998 International Compressor Engineering Conference at Purdue, USA. Vol.2. P.713-718.

Table 1. Compressor Performance with Suction Plenum Temperature

Suction plenum temperature (°C)	Cooling Capacity (Kcal/h)	Input (W)	EER (Btu/Wh)	Current (A)
66.1	239.18	187.92	5.05	1.11
80.8	230.95	186.71	4.91	1.10
89.0	222.61	186.63	4.73	1.10
98.7	217.61	186.22	4.64	1.10

Table 2. Effect of Pressure Drop

Muffler	Pressure drop	Cooling capacity	Input	EEF	EER	Noise
	mmAq	Kcal/h	Watt	Kcal/Wh	BTU/Wh	dB(A)
Case 1	24.7	115.42	111.29	1.04	4.13	45.5
Case 2	14.7	120.45	102.90	1.17	4.64	41.5

Table 3. Physical Property and Boundary Condition for Flow Field Analysis

Physical property		Boundary Condition	
Density	66.16 kg/m ³	Inlet	Pressure B.C., 311K
Specific heat	1218 J/kg k	Outlet	-5m/s in Y direction vector, 350K
Conductivity	0.01659 W/m k		
Viscosity	1.342E-5 kg/m s	Wall	Solid, 340K

Table 4. Performance and Noise in ASHRAE Condition

Muffler	Cooling capacity (Kcal/h)	Input (Watt)	EEF (Kcal/Wh)	EER (BTU/Wh)	Noise (dB(A))
Type A	208.84	170.16	1.23	0.84	45.5-48
Type B	207.93	165.14	1.26	0.81	43.5

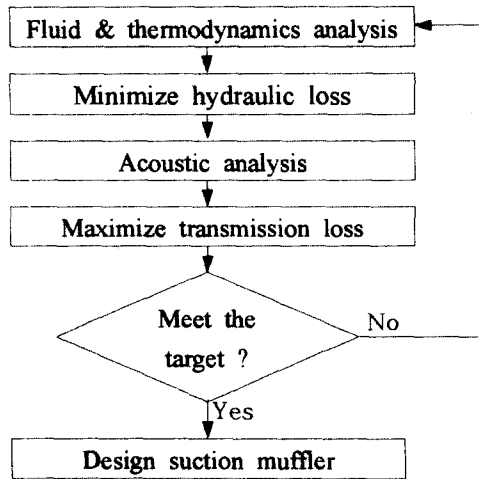

Fig. 1 Diagram of Muffler Design

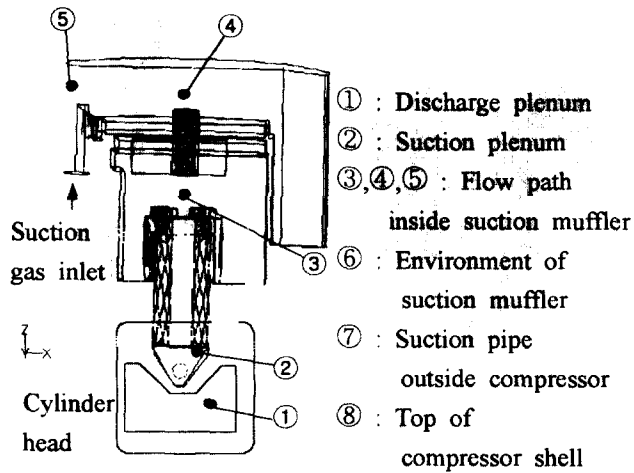

Fig. 2 Temperature Measuring Point in Suction Muffler

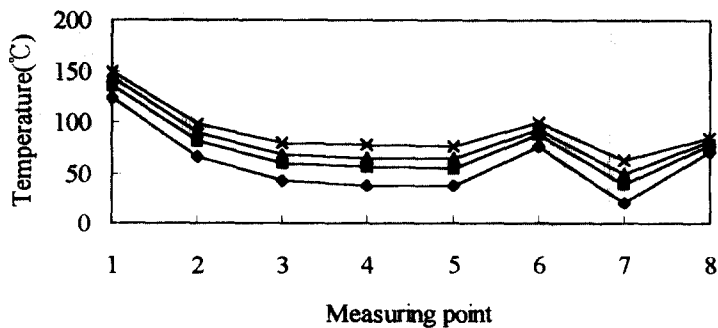

Fig. 3 Temperature Distribution of Measure Points (■ : Normal Condition)

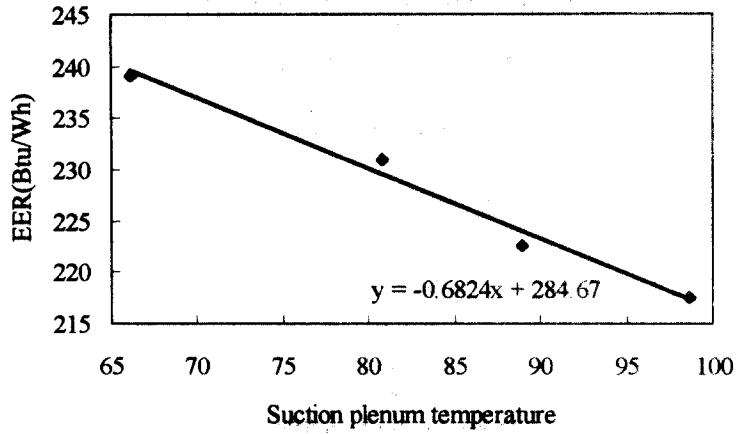

Fig. 4 Suction Plenum Temperature vs EER

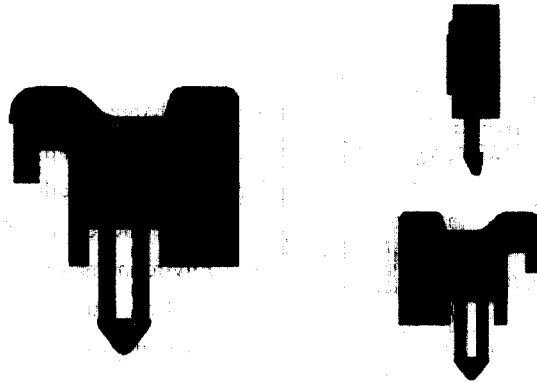

Fig. 5 Muffler Grid of Type B

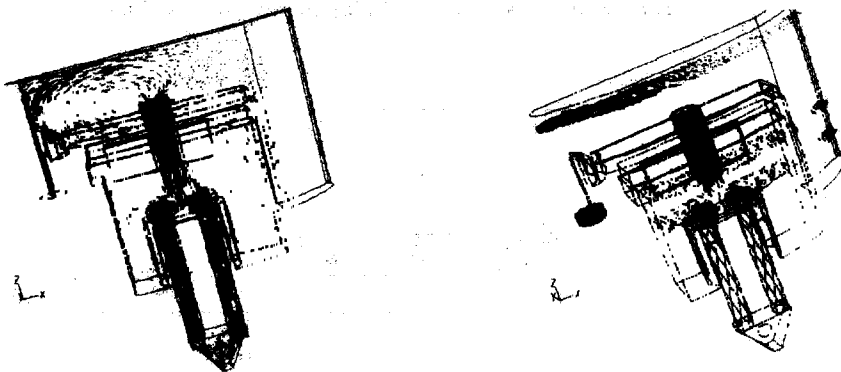

Fig. 6 Flow Field of Type A Muffler

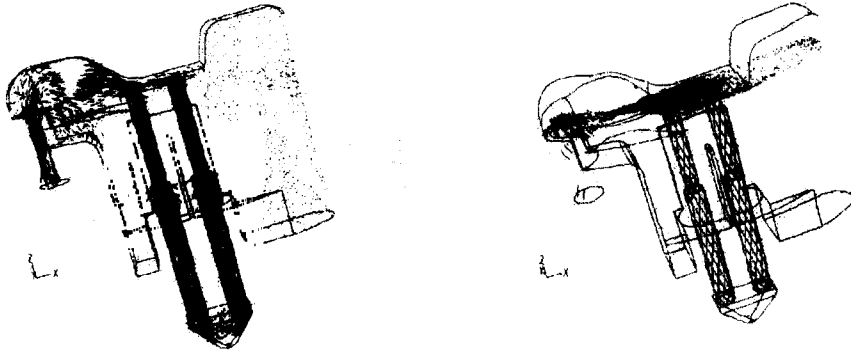

Fig. 7 Flow Field of Type B Muffler

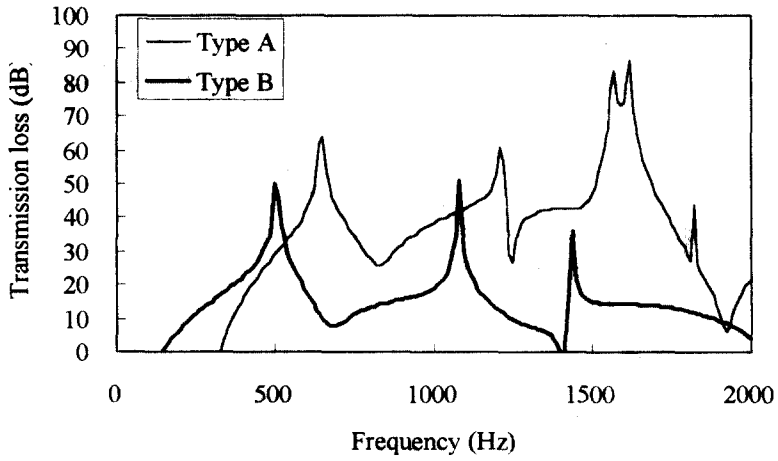

Fig. 8 Calculated Result of Muffler Transmission Loss

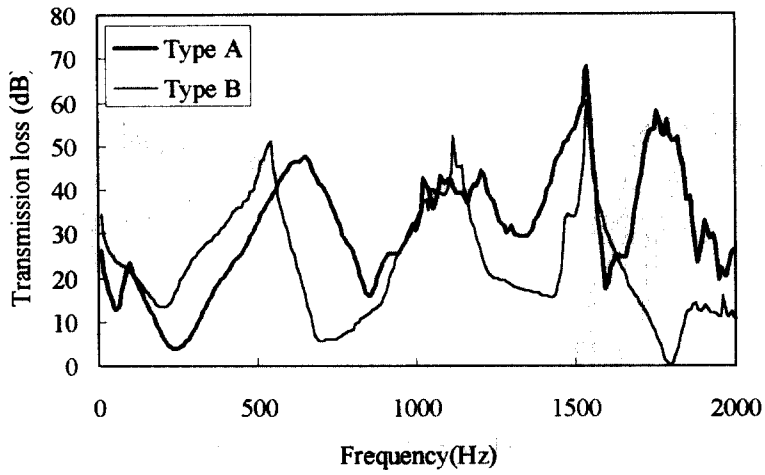

Fig. 9 Experimental Result of Muffler Transmission Loss

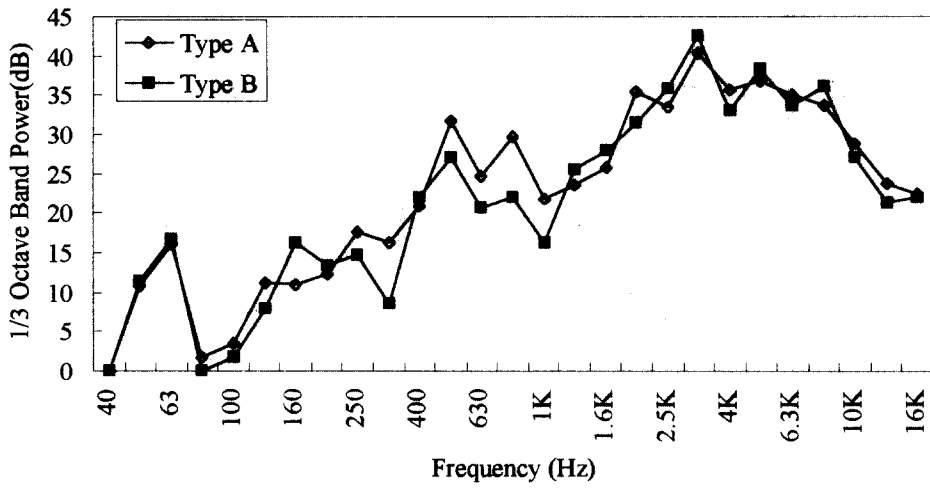

Fig. 10 Noise Spectrum in ASHRAE Condition