

A New Modular 3-phase AC-DC Flyback Converter for Telecommunication

J.Y. Choi, J.P. Lee, I. Choy and J.H. Song
Intelligent System Control Research Center
Korea Institute of Science and Technology
T.Y. Kim
Jeon-Sung Electric Co.

Abstract - A novel mode of parallel operation of a modular 3-phase AC-DC flyback converter for power factor correction along with tight regulation was recently analyzed and presented. The advantage of the proposed converter does not require expensive high voltage and high current devices that are normally needed in popular boost type 3-phase converter. In this paper the detailed small signal analysis of the modular 3-phase AC-DC flyback converter is provided for control purposes and also experimental results are included to confirm the validity of the analysis.

I. INTRODUCTION

Three-phase AC-DC power converters are becoming popular for high voltage/high power applications such as telecommunications. They often require input/output transformer isolation for safety, a unity input power factor for minimum reactive power, free input harmonic currents fed back to the AC power distribution system, and, finally, high efficiency and high power density for minimum weight and volume. In recent years many researches have been focused on achieving the issues mentioned above and quite satisfactory improvements have been published so far [1,2,3]. However, in view point of commercial use, digital control implementation of 3-phase switching power converters are still more complicated and expensive than analog control implementation in spite of their outstanding performance. The proposed parallel operation of a modular 3-phase AC-DC flyback converter for power factor correction has a similar topology to the novel Delco switch-mode-rectifier employing three separate identical single-phase AC-DC converters for each of 3-phase source with the dc output connected in parallel. However, compared with compatible converters for 1-phase and 3-phase [4, 5], the proposed converter shows a fairly good improvement in reducing manufacturing costs due to using one PWM control chip. Furthermore, the proposed scheme offers not only flexibility in either 3-phase 3-wired system or 3-phase 4-wired system but also simpler design, easier testing and higher reliability thanks to the three identical standardized modules. But disadvantages are higher

Proceedings ICPE '98, Seoul

power semiconductor devices and pulsating power flow compared with 3-phase system, which are common to all Delco type of converters. However, since lower rated voltage and current switching devices can be used in each 1-phase, which are cheaper than higher rated ones in 3-phase, a drastic cost reduction was achieved to offset the increased number of semiconductor components in the proposed topology.

Furthermore, the converters described here can be used for either 1-phase or 3-phase with and without the neutral depending on the condition of ac source. The overall schematic diagram of the proposed converter is shown in Fig. 1. The proposed each 1-phase AC-DC converter consists of a 1-phase diode rectifier, a high frequency filter placed on the DC side of the bridge rectifier and an energy storage inductor with step-down ability along with input/output isolation, and a dc-link filter capacitor.

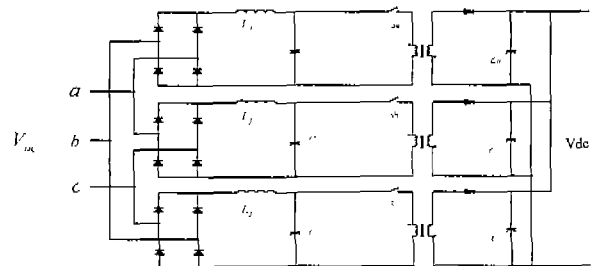

Fig. 1: Overall Schematic Diagram of the Proposed Converter

II. MODELING AND SMALL SIGNAL ANALYSIS OF 3-PHASE AC-DC FLYBACK CONVERTER

In order to implement a stable closed-loop control for a possibly unstable modular flyback system, the incremental dynamics of the proposed system must be clarified. The modeling and small signal analysis of 3-phase AC-DC flyback converter without a high frequency filter placed on the DC side of the bridge rectifier is shown [6] and the control-to-output voltage transfer

function can be shown as following form:

$$T_p(s) \cong \frac{R_o(|v_a| + |v_b| + |v_c|)}{s^2(R_o C_o L) + s(L + R_o R_o C_o) + (R_o + 3R_o)}$$

where

$$R_o \cong -rL$$

$$L - 2rRC_o L \cong L + R_o R_o C_o$$

$$r^2 RC_o L - rL + 3d'R \cong R_o + 3R_o$$

In the above equations C_o is $3C_o$ and r is the almost negligible value of the equivalent winding resistance including the primary and secondary circuits. The configuration requires that three switches in the three identical converter modules must be switched simultaneously for proper operation. The switching action in each module is controlled in such a way that the input line current is shaped into a sinusoidal waveform and is in phase with three corresponding phase voltage, thus producing almost unity factor. In this topology [6], due to the pulsating diode current, low pass filter consisting of inductors and capacitors is connected before the diode bridge rectifier.

The proposed basic single converter module is shown in Fig. 2 and the system equations to develop the transfer functions are listed in Table 1.

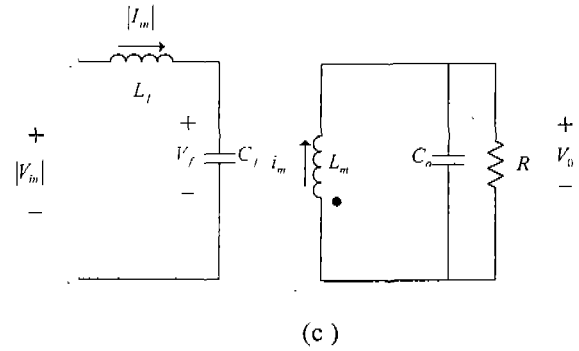

Fig. 2: (a) A Single Module Flyback Converter (b) Circuit Topology during On Time (c) Circuit Topology during Off Time

Table 1

The Modeling of 3 Modular Flyback Converter

step 1 : state-variable description for each circuit state

• switch on state

$$\dot{i}_m = \frac{1}{L_f} [v_m - v_f]$$

$$\dot{v}_f = \frac{1}{C_f} [i_m - i_m]$$

$$\dot{i}_m = \frac{1}{L_m} v_f$$

$$\dot{v}_o = -\frac{1}{RC_o} v_o$$

• switch off state

$$\dot{i}_m = \frac{1}{L_f} [v_m - v_f]$$

$$\dot{v}_f = \frac{1}{C_f} i_m$$

$$\dot{i}_m = \frac{-1}{L_m} v_o$$

$$\dot{v}_o = \frac{3}{C_o} i_m - \frac{1}{RC_o} v_o$$

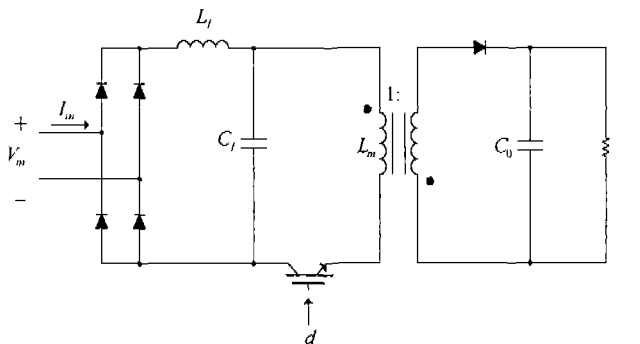

(a)

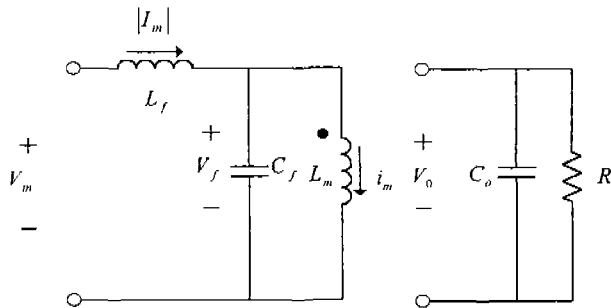

(b)

step 2 : state-space average

$$\dot{i}_m = \frac{1}{L_f} [v_m - v_f]$$

$$\dot{v}_f = \frac{1}{C_f} [i_m - di_m]$$

$$\dot{i}_m = \frac{1}{L_m} [dv_f - (1-d)v_o]$$

$$\dot{v}_o = \frac{3}{C_c} (1-d)i_m - \frac{1}{RC_c} v_o$$

step 3: ac perturbation and linearization

$$i_m = I_m + \hat{i}_m$$

$$v_f = V_f + \hat{v}_f$$

$$i_m = I_m + \hat{i}_m$$

$$v_o = V_o + \hat{v}_o$$

$$d = D + \hat{d}$$

$$\hat{i}_m = \frac{1}{L_f} [V_m - V_f - \hat{v}_f] = -\frac{\hat{v}_f}{L_f}$$

$$\hat{v}_f = \frac{1}{C_f} [\hat{i}_m - (D + \hat{d})(I_m + \hat{i}_m)] = \frac{1}{C_f} [\hat{i}_m - D\hat{i}_m - \hat{d}I_m]$$

$$\begin{aligned} \hat{i}_m &= \frac{1}{L_m} [(D + \hat{d})(V_f + \hat{v}_f) - (1 - D - \hat{d})(V_o + \hat{v}_o)] \\ &= \frac{1}{L_m} (D\hat{v}_f + (V_f + V_o)\hat{d} - (1 - D)\hat{v}_o) \end{aligned}$$

$$\begin{aligned} \hat{v}_o &= \frac{-1}{RC_c} (V_o + \hat{v}_o) + \frac{3}{C_c} (1 - D - \hat{d})(I_m + \hat{i}_m) \\ &= \frac{-1}{RC_c} \hat{v}_o + \frac{3}{C_c} (\hat{i}_m - D\hat{i}_m - I_m\hat{d}) \end{aligned}$$

step 4: frequency domain representation

$$s\hat{i}_m(s) = -\frac{\hat{v}_f(s)}{L_f}$$

$$s\hat{v}_f(s) = \frac{1}{C_f} [\hat{i}_m(s) - D\hat{i}_m(s) - \hat{d}(s)I_m]$$

$$s\hat{i}_m(s) = \frac{1}{L_m} [D\hat{v}_f(s) + (V_f + V_o)\hat{d}(s) - (1 - D)\hat{v}_o(s)]$$

$$(s)\hat{v}_o(s) = \frac{-1}{RC_c} \hat{v}_o(s) + \frac{3}{C_c} (\hat{i}_m(s) - D\hat{i}_m(s) - I_m\hat{d}(s))$$

step 5: control to output voltage transfer function

$$\frac{v_o(s)}{d(s)} = \frac{3R[s^3(-I_m L_m C_c L_c) + s^2(1-D)(V_f + V_o)L_f C_c + s(-(1-D)D I_m L_f - I_m L_m - I_m D^2 L_c) + (1-D)(V_f + V_o)]}{s^4(RC_c L_m C_c L_c) + s^3 L_m C_c L_c + s^2(RC_c(L_m + D^2 L_c) + 3R(1-D)^2 C_c L_f) + s(L_m + D^2 L_c) + 3R(1-D)^2}$$

where

$$D = \frac{V_o}{V_o + v_m}$$

$$I_m = \frac{I_m}{D}$$

$$V_f = v_m = |v_a| + |v_b| + |v_c|$$

For designing voltage loop controller open-loop bode plots of Dr. Hui's system [6] and given system ($V_{in} = 380\text{VAC}$, $V_{out} = 48\text{VDC}$) are shown in Fig. 3(a), (b), respectively, based on the following circuit parameters:

$$L_m = 500\mu\text{H}, C_c = 1700\mu\text{F}, L_f = 2.4\text{mH}, C_f = 1\mu\text{F}, R = 5\Omega$$

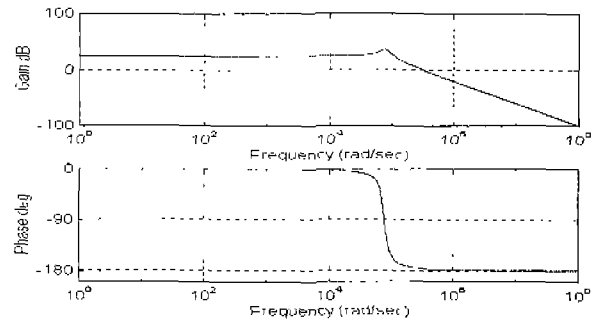

(a)

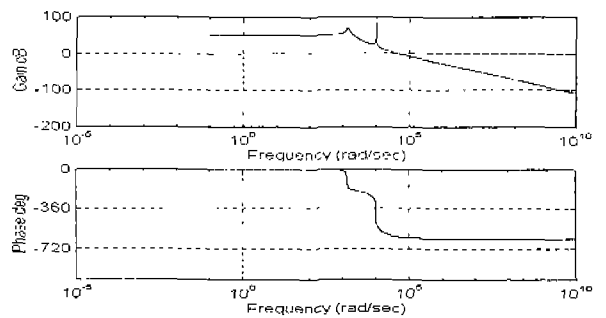

(b)

Fig. 3: Bode Plot of the Open-Loop System
(a) Hui's system (b) Proposed System

to compensate phase margin of both systems, each different compensator of Fig. 4 (a), (b) is designed properly, providing 58° and 47° of phase margin shown Fig. 5 (a), (b), correspondingly.

(a) Hui's system (b) Proposed System

III. PSpice SIMULATION AND IMPLEMENTATION OF 3-PHASE AC-DC FLYBACK CONVERTER

Recently, newly developed special ICs lower the cost of the switch-mode power supply circuits. The Unitrode 3825 is the one of resulting ICs, which is designed to optimally facilitate a PWM controller using voltage mode and current mode control. The average PSpice model of flyback converter is more effective to simulate a few line cycle without time convergence error for verification of power factor correction circuits. Figures 6, 7, 8 and 9 show a schematic, a detailed diagram of the UC3825, a schematic of 3-phase 3-wired and 3-phase 4-wired given flyback converter system using PSpice.

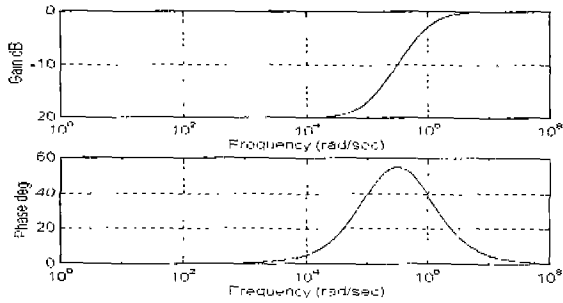

(a)

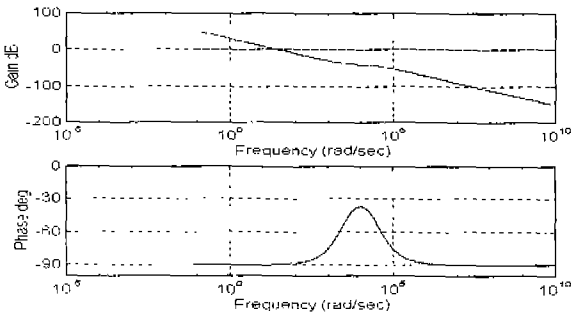

(b)

Fig. 4: (a) Lead Compensator for the Hui's System (b) 2-pole 1-zero Compensator for the Proposed System

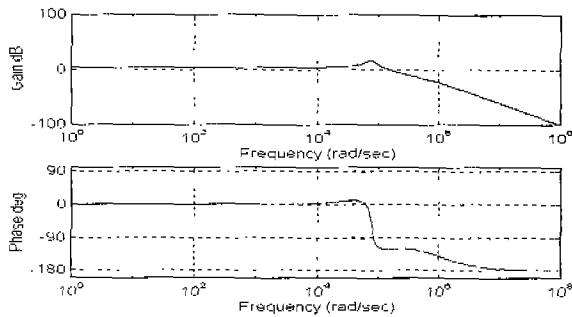

(a)

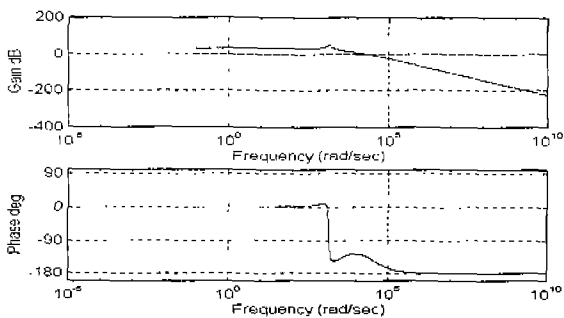

(b)

Fig. 5: Bode Plot of the Closed-Loop System

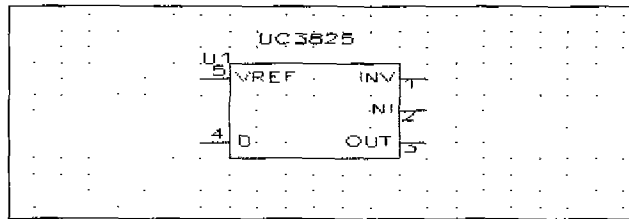

Fig. 6: PSpice Model of UC3825

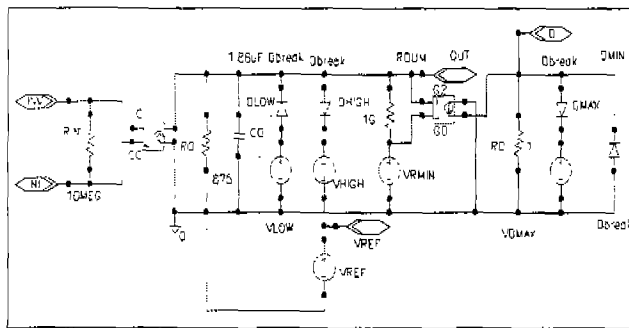

Fig. 7: Equivalent Circuit of UC3825

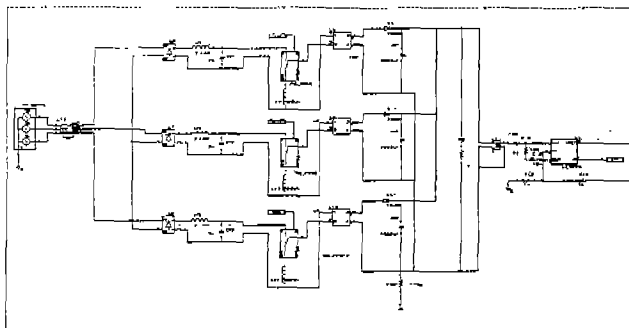

Fig. 8: A Schematic of the Modular 3-wired AC-DC Flyback Converter

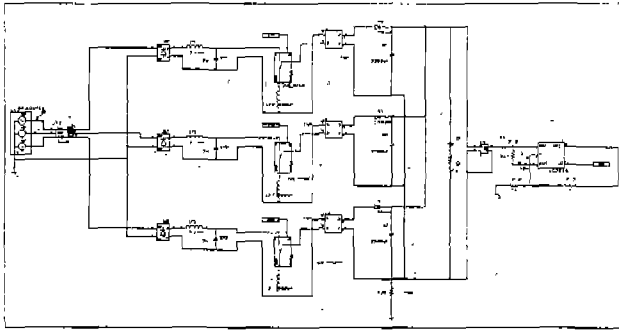
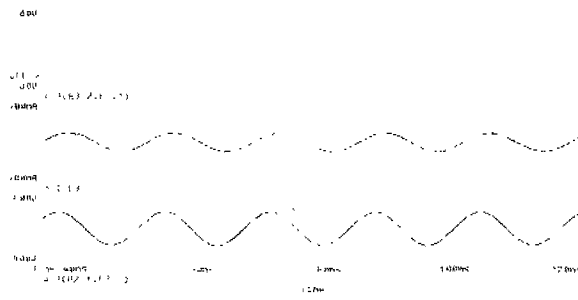
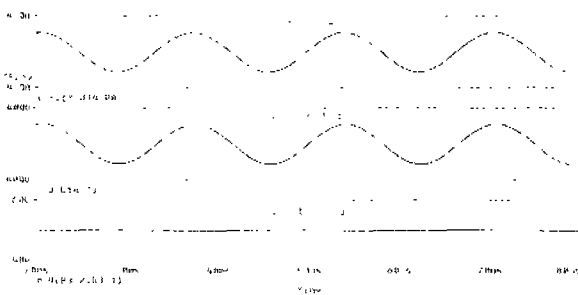

Fig. 9: A Schematic of the Modular 4-wired AC-DC Flyback Converter

Based on each schematic of 3-wired and 4-wired system, output voltage, input current and input voltage waveforms are shown Fig. 10 and 11, correspondingly. Figures 12, 13, 14 and 15 compare the spectra of simulated input current which show almost the same amount of the harmonic contents in the 3-wired and 4-wired system at each type of converter.



(a)



(b)

Fig. 10: Waveform of the Modular 3-wired AC-DC Flyback Converter
(a)Hui's system (b) Proposed System

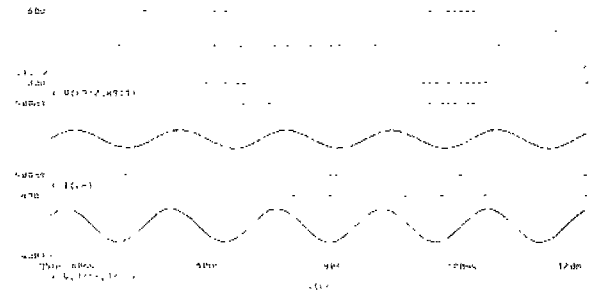

(a)

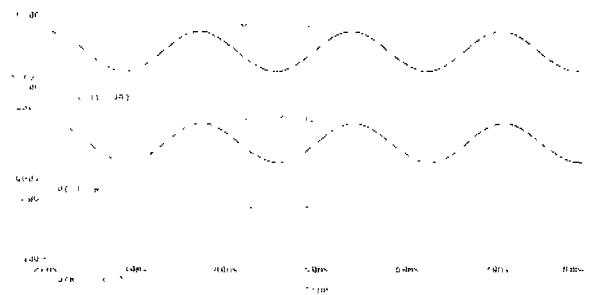

(b)

Fig. 11: Waveform of the Modular 4-wired AC-DC Flyback Converter
(a)Hui's system (b) Proposed System

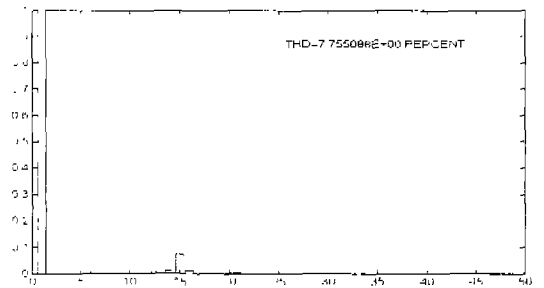

Fig. 12: Harmonic Spectrum of the Input Phase Current in the 3-wired Hui's Flyback Converter

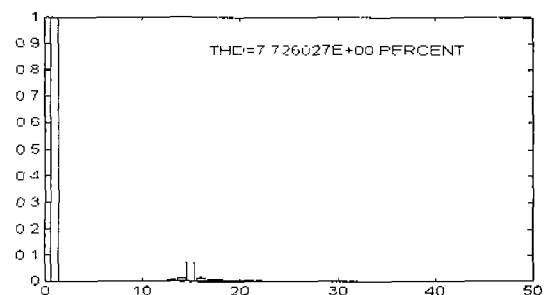

Fig. 13: Harmonic Spectrum of the Input Phase Current in the 4-wired Hui's Flyback Converter

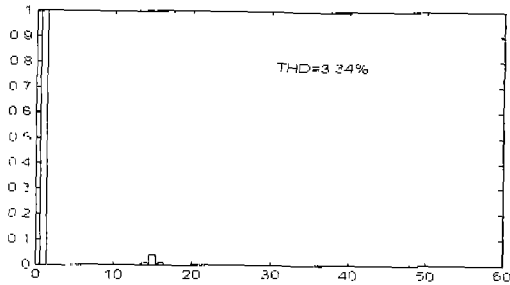

Fig. 14: Harmonic Spectrum of the Input Phase Current in the 3-wired Proposed Converter

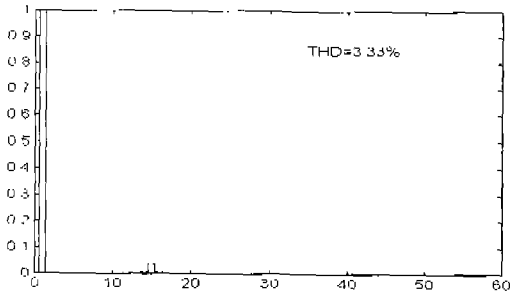

Fig. 15: Harmonic Spectrum of the Input Phase Current in the 4-wired Proposed Converter

Owing to the close modeling of the proposed system, harmonic contents in both 3-wired and 4-wired system were reduced to the amount of less than half compared with the Hui's system. Experiments were completed for both cases and Figs. 16 and 17 show the line-to neutral input voltage, current waveforms and DC output voltage of the 3-phase 3-wired system (Hui's topology), respectively. Nearly sinusoidal input current is shown providing high power factor. At full load, the total current harmonics of the 3-phase 3-wired connection is 7.95%, which is somewhat larger than those of simulated case, 7.55%. This could be due to variations of power circuits and control parameters of each individual module. However, the line-to neutral input voltage, current waveforms of the proposed system shown in Fig. 18 is exactly in phase with the corresponding input voltage and the resulting power factor is 0.99, showing the advantages of the proposed topology.

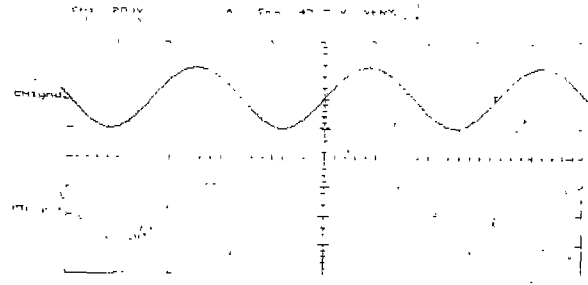

Fig. 16: 3-Phase Connection upper: v_{an} , lower: i_{an} , sweep: 5ms/div

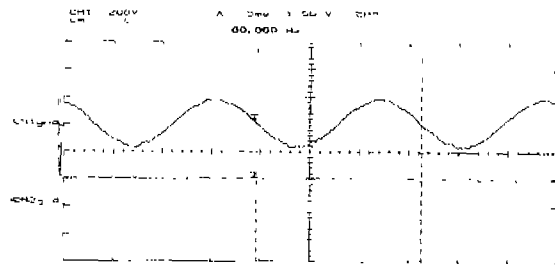

Fig. 17: 3-Phase Connection upper: v_{an} , lower: v_{out} , sweep: 5ms/div

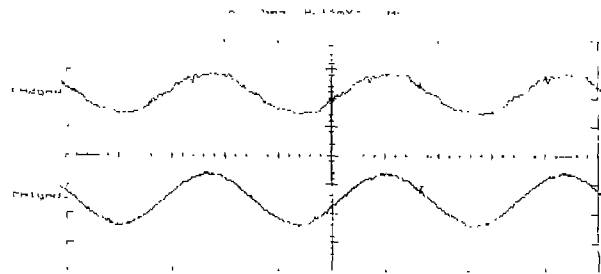

Fig. 18: Waveforms of the Proposed System upper: i_{an} , lower: v_{an} , sweep: 5ms/div

IV. CONCLUSIONS

This paper addresses the analysis and design of a modular 3-phase AC-DC flyback converter, which draws high quality input current waveforms along with 3-phase 4-wired input/3-phase 4-wired input compatibility. The experimental results of the proposed converter provide an excellent power factor along with drastic cost reduction. Three individual 1-phase 1 kw AC-DC power modules operating at 100 khz were constructed for telecommunication applications to verify the validity of the modeling and analysis of the proposed system.

REFERENCES

- [1] A. Busse; J. Holtz: Multiloop control of a unity power factor fast switching ac to dc converter, Proc. of IEEE PESC 1982, pp. 171-179
- [2] L. Malesani; P. Tenti: Three-phase ac/dc PWM converter with sinusoidal input currents and minimum filter requirements, IEEE Trans. Ind. Appl., vol. IA-23, no. 1, 1987, pp. 71-77
- [3] V. Vlatkovich; D. Boroyevish: Digital-signal-processor-based control of three-phase, space vector modulated converters, IEEE Trans. Ind. Electron., vol. IE-41, no. 3, 1995, pp. 148-157
- [4] M.J. Kocher; R.L. Steigerwald: An AC to DC converter with high quality input waveforms, IEEE Trans. Power Electronics, 1982, pp. 63-75
- [5] J.Y. Choi, H.S. Mok, T.Y. Kim, "A Single-Phase/Three-Phase Compatible Soft-Switched AC-to-DC Converter," Proc. of Seventh European Conference on Power Electronics and Applications, Nov. 1997, pp. 464-469
- [6] S.Y.R. Hui, H. Chung: "Paralleling power converters for AC-DC step-down power conversion with inherent power factor correction," Proc. of Seventh European Conference on Power Electronics and Applications, Nov. 1997, pp. 182-187