

## Observer Based Sensorless Force Control of Robot Manipulator

Il Hong Suh, Kwang Sik Eom, and Chang Eun Lee  
Dept. of Electronic Eng., Hanyang Univ.

Tel:+82-345-408-5802;Fax:+82-345-408-5803;e-mail:celee@scorpio.hanyang.ac.kr

### Abstract

In this paper, a force estimation method is proposed for the sensorless force control. For this, a disturbance observer is applied to each joint of an  $n$  degrees of freedom manipulator to obtain a simple equivalent robot dynamics(SERD) being represented as an  $n$  independent double integrator system. To estimate the output of disturbance observer in the absence of external force, the observer estimator is designed, where the uncertain parameters of the robot manipulator are adjusted by gradient method to minimize the output between the disturbance observer and the observer estimator. When the external force is exerted, the external force is estimated using the difference between the output of disturbance observer which include the external torque signal and that of observer estimator. And then, a force controller is designed for force feedback control employing the estimated force signal. To verify the effectiveness of the proposed force estimation method, several numerical examples are illustrated for the 2-axis planar type robot manipulator.

### 1. Introduction

Many robotic tasks, such as deburring, grinding and precision assembly, require the end-effector of the robot to establish and maintain contact with environment. For successful execution of such tasks, both the force control and the position control of robot manipulator must be simultaneously controlled. Although the force control is needed for the precision control of robot manipulator, it is not popular in industrial application due to the high price of sensors and the lacks of appropriate control algorithms. Moreover, when the robot manipulator has the effects of high temperature, large noise and so on, the force sensor cannot be mounted to it. To overcome these problems, several force estimation methods are researched[2]. Recently, disturbance observer based control algorithm has been reported to compensate modeling uncertainties as well as external disturbance. The disturbance observer regards the difference between the actual output and the output of nominal model as an equivalent disturbance applied to the nominal model. When the robot manipulator contact with environments, the equivalent disturbance signal includes not only the modeling uncertainties but also the external force exerted by environments. Therefore the problem of the force estimation based on disturbance observer is to find only the external force from the equivalent disturbance signal. Ohishi and his coworkers proposed the force estimation method based on disturbance observer. In this scheme, the modeling uncertainties terms are constructed by using experimentally obtained datas, and the external torques are calculated by subtraction the established modeling uncertainties seems not to include completely the inertia force, coriolis force and so on. In this paper, to obtain the force information from the equivalent disturbance signal the modeling uncertainties term is modeled by using robot dynamic equation. To estimate the output of disturbance observer in the absence of external force, the observer estimator is designed, where the uncertain parameters of the robot manipulator are adjusted by gradient method to minimize the difference between the disturbance observer and the observer estimator. When robot manipulator contacts with the environments, the exerted force is estimated using the

difference between the output of observer estimator and the output of disturbance observer which include the external torque signal. The estimated force signal can be used for force feedback control. To verify the effectiveness of the proposed force estimation method, the numerical simulation are performed for the 2-axis planar type manipulator.

### 2. Disturbance Observer based Position Controller Design

Consider the dynamics of an  $n$  link robot manipulator given by a set of highly nonlinear and coupled differential equations as

$$M(q)\ddot{q} + c(q, \dot{q}) + g(q) + f(\dot{q}) = \tau, \quad (1)$$

where  $M(q)$  is the  $n \times n$  inertia matrix and  $c(q, \dot{q})$ ,  $g(q)$ ,  $f(\dot{q})$  are respectively the  $n \times 1$  vectors of the Coriolis and centrifugal forces, the gravity loading, and the friction force. And  $\tau$  is the  $n \times 1$  torque vector applied to the joint of robot manipulator.  $q, \dot{q}, \ddot{q}$  are the  $n \times 1$  vectors representing angular position, velocity and acceleration, respectively. Now, the robot dynamics can be rewritten as a fixed inertia term plus an equivalent disturbance torque given by

$$M_n \ddot{q} + \tau_d(q, \dot{q}, \ddot{q}) = \tau, \quad (2)$$

where  $M_n \equiv \text{diag}\{M_{11}^n, \dots, M_{nn}^n\}$  is  $n \times n$  diagonal matrix. Here,  $M_{ii}^n$  is the constant-valued nominal inertia term of the  $i$ th axis which can be measured by frequency response[1].

$\tau_d(q, \dot{q}, \ddot{q}) \equiv [\tau_{1d}, \dots, \tau_{nd}]^T$  is the  $n \times 1$  vector implying equivalent disturbance including all the unmodeled dynamics, such as nonlinearity, coupling effects and payload uncertainty.

$\tau_d$  can be written as Eq.(3) and the disturbance of  $i$ th axis can be represented as Eq.(4).

$$\tau_d = (M(q) - M_n)\ddot{q} + c(q, \dot{q}) + g(q) + f(\dot{q}), \quad (3)$$

$$\tau_{id} = \sum_{j=1, j \neq i}^n M_{ij}(\mathbf{q}) \ddot{q}_j + \sum_{j=1}^n \sum_{k=1}^n c_{ijk} \dot{q}_j \dot{q}_k + g_i + f_i + (M_{ii}(\mathbf{q}) - M_{ii}^n) \ddot{q}_i. \quad (4)$$

If the equivalent disturbance in Eq.(4) can be obtained, dynamics of each axis can be decoupled by eliminating the equivalent disturbance. Thus, a simple control strategy is sufficient to track a desired trajectory  $\mathbf{q}_d(t)$ . The equivalent disturbance can be estimated by disturbance observer[4,8] and can be suppressed by adding the estimated disturbance signal to the control input. Fig 1. shows a structure of the disturbance observer for the  $i$ th single axis. In Fig.1,  $P_{in}(s)$  is the nominal plant of the real system  $P_i(s)$  where  $P_{in}(s)$  is given as  $1/M_{ii}^n s$ , and  $Q_i(s)$  is a low pass filter that is employed to realize  $P_{in}^{-1}(s)$  and to reduce the effect of measurement noise.

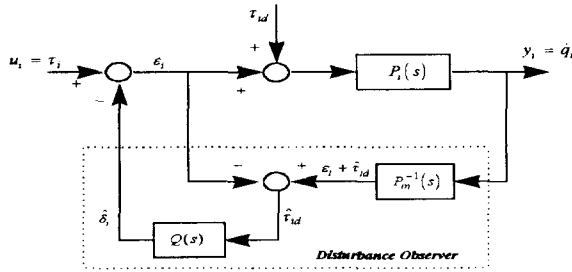

Fig.1. A structure of disturbance observer

The input-output relation can be obtained as follows:

$$y_i = G_{u_i, y_i}(s) u_i + G_{\tau_{id}, y_i}(s) \tau_{id}, \quad (5)$$

where  $G_{u_i, y_i}(s)$  and  $G_{\tau_{id}, y_i}(s)$  can be written as Eq.(6), Eq.(7) in the above equation.

$$G_{u_i, y_i} = \frac{P_i(s) P_{in}(s)}{P_{in}(s) + (P_i(s) - P_{in}(s)) Q_i(s)}, \quad (6)$$

$$G_{\tau_{id}, y_i} = \frac{P_i(s) P_{in}(s) (1 - Q_i(s))}{P_{in}(s) + (P_i(s) - P_{in}(s)) Q_i(s)}. \quad (7)$$

From the above equations, it can be observed that  $Q_i(s)$  plays the most significant role of determining robustness and disturbance suppression performance of the system in the design of disturbance observer. If  $Q_i(s) \approx 1$ , the transfer functions is reduced to

$$G_{u_i, y_i}(s) \approx P_{in}(s), \quad G_{\tau_{id}, y_i}(s) \approx 0. \quad (8)$$

This implies that for a disturbance signal whose maximum frequency is lower than cut-off frequency of  $Q_i(s)$ , the disturbance signal is effectively rejected and the real plant behaves as a nominal plant. if  $Q_i(s) \approx 0$  then Eq.(9) can be achieved from Eq.(6), Eq.(7)

$$G_{u_i, y_i}(s) \approx P_i(s), \quad G_{\tau_{id}, y_i}(s) \approx P_i(s) \quad (9)$$

We can see by this equation that in such cases the

disturbance observer does not affect the system. Therefore, if such a disturbance observer is employed for every joint of a manipulator, then the robot dynamics can be considered as the simple equivalent dynamics (SERD : Simple Equivalent Robot Dynamics) system given by

$$\mathbf{M}_n \ddot{\mathbf{q}} = \boldsymbol{\tau}. \quad (10)$$

Trajectory planning for robot's operation is an off-line procedure resulting in a nominal trajectory to be used as a reference trajectory in Cartesian space. The forward kinematics is given as

$$\mathbf{p} = \mathbf{k}(\mathbf{q}), \quad (11)$$

$$\dot{\mathbf{p}} = \mathbf{J}(\mathbf{q}) \dot{\mathbf{q}}, \quad (12)$$

$$\ddot{\mathbf{p}} = \dot{\mathbf{J}}(\mathbf{q}, \dot{\mathbf{q}}) \dot{\mathbf{q}} + \mathbf{J}(\mathbf{q}) \ddot{\mathbf{q}}, \quad (13)$$

where  $\mathbf{J}(\mathbf{q})$  is the Jacobian matrix and  $\dot{\mathbf{J}}(\mathbf{q})$  is the derivative of  $\mathbf{J}(\mathbf{q})$ . If the disturbance in Eq.(2) is canceled by the disturbance observer, a simple PD control action is sufficient to drive  $\mathbf{q}$  to track a desired trajectory  $\mathbf{q}_d$ . Fig.2 show the disturbance observer based independent joint control scheme to perform tasks planned in Cartesian space.

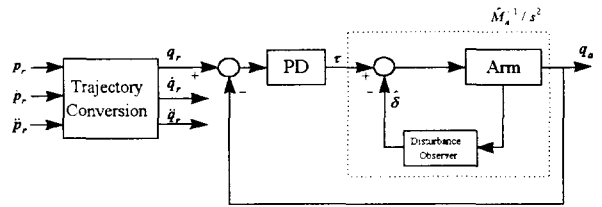

Fig.2. Disturbance observer based independent joint control scheme in Cartesian space

### 3. Disturbance Observer based Force Estimator

When the external force is not exerted, the output of disturbance observer expressed in Eq.(3) can be written as

$$\tau_d = \mathbf{W}(\mathbf{q}, \dot{\mathbf{q}}, \ddot{\mathbf{q}}) \boldsymbol{\varphi}, \quad (14)$$

where  $\boldsymbol{\varphi}$  is the  $r \times 1$  unknown parameter vector and  $\mathbf{W}(\mathbf{q}, \dot{\mathbf{q}}, \ddot{\mathbf{q}})$  is  $n \times r$  matrix of robot functions depending on the joint variables. This matrix may be computed for any given robot arm. The output of observer estimator can be given as

$$\begin{aligned} \hat{\tau}_d &= (\hat{\mathbf{M}}(\mathbf{q}) - \mathbf{M}_n) \ddot{\mathbf{q}} + \hat{\mathcal{C}}(\mathbf{q}, \dot{\mathbf{q}}) + \hat{\mathbf{g}}(\mathbf{q}) + \hat{\mathbf{f}}(\dot{\mathbf{q}}) \\ &= \mathbf{W}(\mathbf{q}, \dot{\mathbf{q}}, \ddot{\mathbf{q}}) \hat{\boldsymbol{\varphi}} \end{aligned} \quad (15)$$

where  $\hat{\boldsymbol{\varphi}}$  is the estimation of the unknown parameter vector. The error between the output of disturbance observer and that of observer estimator is defined as  $\tilde{\tau}_d = \tau_d - \hat{\tau}_d$ , and if the performance index of observer estimator is defined as

$$J = \frac{1}{2} \tilde{\tau}_d^T \tilde{\tau}_d, \quad (16)$$

then the parameter update rule for reducing the error by using the gradient method can be written as

$$\hat{\varphi} = -\Gamma W^T(q, \dot{q}, \ddot{q}) \tilde{\tau}_d, \quad (17)$$

where  $\Gamma$  is  $r \times r$  diagonal matrix that represents the positive valued parameter update rate. The block diagram of observer estimator is depicted in Fig.3.

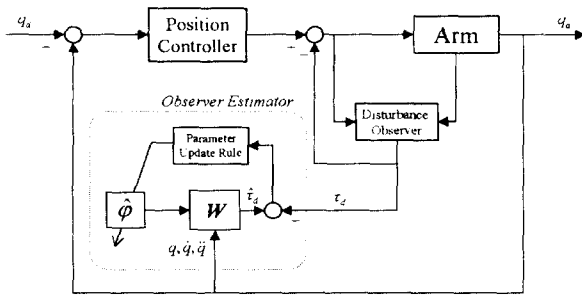

Fig.3 The block diagram of observer estimator

When the robot manipulator contacts with the environments, the output of disturbance observer include the external force exerted by environments and it can be written as

$$\tau_d = (M(q) - M_n) \ddot{q} + c(q, \dot{q}) + g(q) + f(\dot{q}) + \tau_e, \quad (19)$$

where  $\tau_e$  is  $n \times 1$  external torque vector. External torque can be calculated by subtraction the output of observer estimator from the output of disturbance observer which include external torque. This external torque is obtained as

$$\hat{\tau}_e = \tau_d - \hat{\tau}_d. \quad (20)$$

The external force can be obtained using Jacobian matrix as follows.

$$\hat{f}_e = (J^T(q))^{-1} \hat{\tau}_e \quad (21)$$

The block diagram of force estimator using observer estimator and disturbance observer is shown in Fig.4.

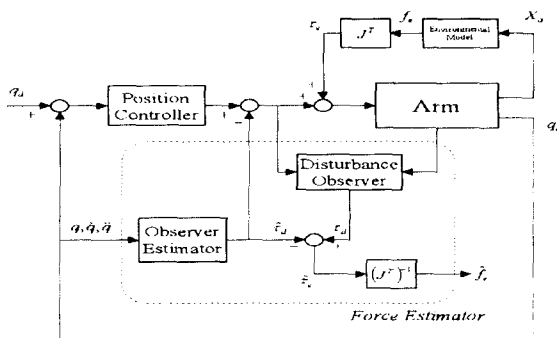

Fig.4 The block diagram of force estimator

When the end-effector contacts with an external environment, the relationship between force displacement and position displacement can be expressed as

$$\delta f = K_E \delta x, \quad (22)$$

where  $\delta f$  and  $\delta x$  are, respectively  $n \times 1$  displacement of force and position, and  $K_E$  are  $n \times n$  environment stiffness matrix in cartesian space. The relationship of minimal displacement between the cartesian coordinate and the joint coordinate can be shown as

$$\delta x = J(q) \delta q. \quad (23)$$

By substituting Eq.(23) into Eq.(22), Eq.(24) can be obtained as follows.

$$\delta f = K_E J(q) \delta q \quad (24)$$

Eq.(24) can be converted to Eq.(25) by multiplying the inverse matrices at each sides.

$$\delta q = J(q)^{-1} K_E^{-1} \delta f \quad (25)$$

For force feedback controls whose output is given as the position displacement in cartesian space, the controller design problem is to find  $\delta f$  as a function of force error signal. Fig.5 shows the block diagram of the hybrid position and force control using force estimator.

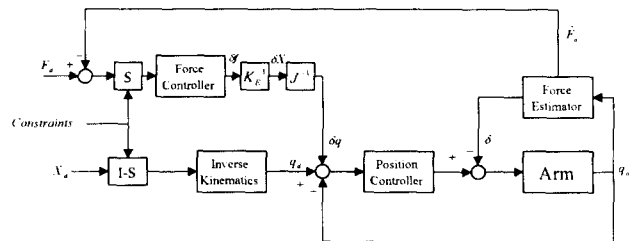

Fig. 5 The block diagram of hybrid position and force control using force estimator

## 4. Simulation Results

To show the efficiency of force estimation method, several simulations were performed by employing a 2-link planar type robot manipulator. To simulate the unknown parameter estimation, uncertain parameters of the robot manipulator are defined as  $\hat{\varphi} = [\hat{m}_1 \hat{m}_2]^T$  where  $\hat{m}_i$  is the mass of  $i$ th axis. And  $\hat{\varphi}$  are adjusted by gradient method to minimize the difference between the disturbance observer and observer estimator, where the position command is given as  $q_{d1} = \sin t$ ,  $q_{d2} = \cos t$ . Actual mass of the robot are given as  $\varphi = [0.8 \ 2.3]^T$  Kg. Initial mass for disturbance

observer and observer estimator are given as  $\hat{\varphi} = [1 \ 3]^T Kg$ . Fig.6 show that the estimated mass of the robot manipulator is converged to the actual mass of the robot manipulator after 4 [sec]. The performance of observer estimator is shown in Fig.7, where the output of observer estimator goes to that of disturbance observer after a time consuming learning process, about 4 [sec].

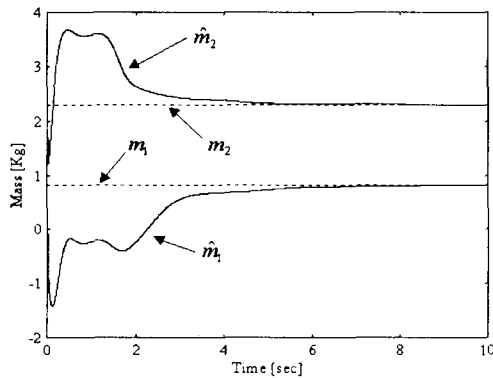

Fig. 6 The mass estimation of observer estimator

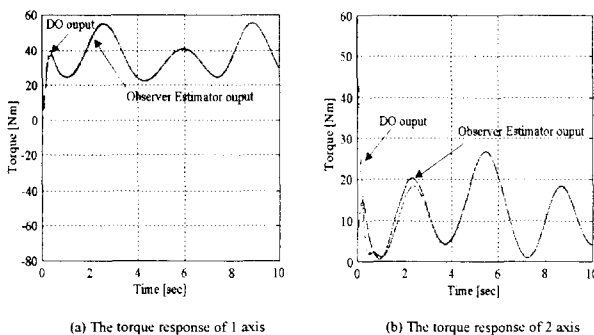

Fig. 7 The output of observer estimator and disturbance observer

When are external force which is given as  $f_e = [\sin t \ \sin t]^T$  is exerted to the robot manipulator, the estimated force by the proposed force estimator is depicted in Fig.8. In this figure, it can be observed that the external force is coincide with the estimated force.

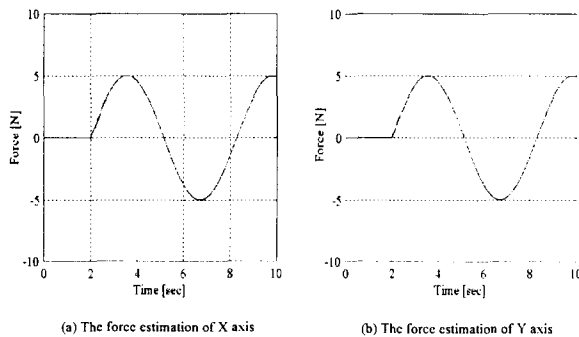

Fig. 8 The force estimation by force estimator

When the hybrid position and force controller using the estimated force is constructed as shown in Fig.5, the force responses are shown in Fig.9, where the dotted lines and solid lines represent the desired forces and actual forces,

respectively. It is observed from Fig.9 that in spite of the absent of force sensor, the responses has good performance in the sense of small overshoot and fast rising time.

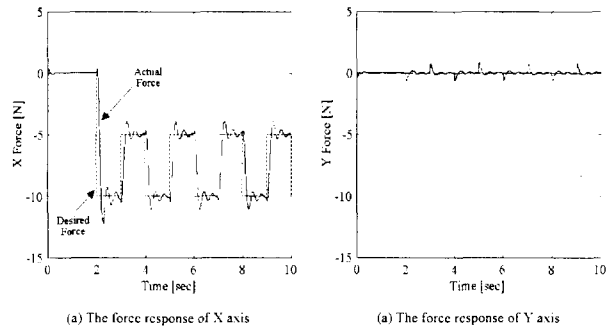

Fig. 9 The force response

## 5. Conclusions

A hybrid control system is proposed by both robust position controller and force controller using the force estimator. The proposed control system doesn't need force sensor. The robust position controller is designed on the basis of SERD using disturbance observer. The force estimator is constructed by developing both disturbance observer and the observer estimator. The proposed sensorless force system well regulates both the force to the target environment and the position of robot manipulator.

## References

- [1] K.S.Eom and I.H.Suh, "Disturbance Observer Based Path Tracking Control of Robor Manipulator Considering Torque Saturation," Proceedings of International Conference on Advanced Robotics, 1997.
- [2] K.Ohishi, et al., "Force Control without Force Sensor Based on Mixed Sensitivity  $H^\infty$  Design Method," Proc. of 1992 IEEE Int. Con. on Robotics and Automation, vol. 2, pp. 1356-1361, 1992.
- [3] K.Ohishi, K.Akatori, W.Kaewprom and T.Mashimo, "Robust manipulator control method considering limit values of torque and controller output," Proceedings of the IEEE Industrial Electronics Conference, pp. 1252-1257, 1996
- [4] K.Ohishi, "A new servo method in mechatronics," Trans. on Japanese Society of Electrical Engineering, vol. 107-D, pp. 83-86, 1987
- [5] T.C.Hsia, T.A.Lasky, and Z.Y.Guo, "Robust independent robot joint control: design and experimentation," Proceedings of IEEE International Conference on Robotics and Automation, pp. 1329-1334, 1988
- [6] O.Dahl and L.Nielsen, "Torque-limited path following by on-line trajectory time scaling," IEEE Trans. on Robotics and Automation, vol. 6, no. 5, pp. 554-561, 1990
- [7] T.Umeno and Y.Hori, "Robust speed control of dc servomotors using modern two degrees-of-freedom controller design," IEEE Trans. on Industrial Electronics, vol. 38, no. 5, pp. 363-368, 1991.
- [8] H.S.Lee, "Robust Digital Tracking Controllers for High-Speed/High-Accuracy Positioning System," Ph.D. Dissertation, U.C Berkeley, 1994